

Darlington Transistors

NPN Silicon

- We declare that the material of product compliance with RoHS requirements.

Ordering Information

Device	Marking	Shipping
LMBT6427LT1G	1V	3000/Tape&Reel
LMBT6427LT3G	1V	10000/Tape&Reel

MAXIMUM RATINGS

Rating	Symbol	Value	Unit
Collector–Emitter Voltage	V_{CEO}	40	Vdc
Collector–Base Voltage	V_{CBO}	40	Vdc
Emitter–Base Voltage	V_{EBO}	12	Vdc
Collector Current — Continuous	I_C	500	mAdc

THERMAL CHARACTERISTICS

Characteristic	Symbol	Max	Unit
Total Device Dissipation FR–5 Board, (1) $T_A = 25^\circ\text{C}$	P_D	225	mW
Derate above 25°C		1.8	mW/ $^\circ\text{C}$
Thermal Resistance, Junction to Ambient	$R_{\theta JA}$	556	$^\circ\text{C}/\text{W}$
Total Device Dissipation Alumina Substrate, (2) $T_A = 25^\circ\text{C}$	P_D	300	mW
Derate above 25°C		2.4	mW/ $^\circ\text{C}$
Thermal Resistance, Junction to Ambient	$R_{\theta JA}$	417	$^\circ\text{C}/\text{W}$
Junction and Storage Temperature	T_J, T_{stg}	-55 to +150	$^\circ\text{C}$

DEVICE MARKING

LMBT6427LT1G = 1V

ELECTRICAL CHARACTERISTICS ($T_A = 25^\circ\text{C}$ unless otherwise noted.)

Characteristic	Symbol	Min	Max	Unit
----------------	--------	-----	-----	------

OFF CHARACTERISTICS

Collector–Emitter Breakdown Voltage(3) ($I_C = 10 \text{ mAdc}, V_{BE} = 0$)	$V_{(BR)CEO}$	40	—	Vdc
Collector–Base Breakdown Voltage ($I_C = 100 \mu\text{Adc}, I_E = 0$)	$V_{(BR)CBO}$	40	—	Vdc
Emitter–Base Breakdown Voltage ($I_E = 10 \mu\text{Adc}, I_C = 0$)	$V_{(BR)EBO}$	12	—	Vdc
Collector Cutoff Current ($V_{CE} = 25\text{Vdc}, I_B = 0$)	I_{CES}	—	1.0	μAdc
Collector Cutoff Current ($V_{CB} = 30\text{Vdc}, I_E = 0$)	I_{CBO}	—	50	nAdc
Emitter Cutoff Current ($V_{EB} = 10\text{Vdc}, I_C = 0$)	I_{EBO}	—	50	nAdc

1. FR–5 = 1.0 x 0.75 x 0.062 in.

2. Alumina = 0.4 x 0.3 x 0.024 in. 99.5% alumina.

LMBT6427LT1G

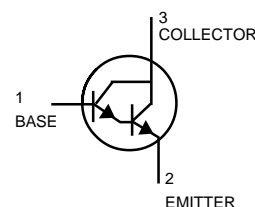
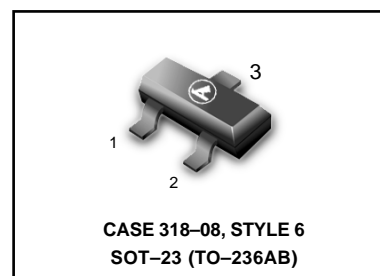

LMBT6427LT1G

ELECTRICAL CHARACTERISTICS ($T_A = 25^\circ\text{C}$ unless otherwise noted) (Continued)

Characteristic	Symbol	Min	Max	Unit
----------------	--------	-----	-----	------

ON CHARACTERISTICS

DC Current Gain ($I_C = 10\text{ mAdc}, V_{CE} = 5.0\text{ Vdc}$) ($I_C = 100\text{ mAdc}, V_{CE} = 5.0\text{ Vdc}$) ($I_C = 500\text{ mAdc}, V_{CE} = 5.0\text{ Vdc}$)	h_{FE}	10,000 20,000 14,000	100,000 200,000 140,000	—
Collector–Emitter Saturation Voltage ($I_C = 50\text{ mAdc}, I_B = 0.5\text{ mAdc}$) ($I_C = 500\text{ mAdc}, I_B = 0.5\text{ mAdc}$)	$V_{CE(sat)}(3)$	— —	1.2 1.5	Vdc
Base–Emitter Saturation Voltage ($I_C = 500\text{ mAdc}, I_B = 0.5\text{ mAdc}$)	$V_{BE(sat)}$	—	2.0	Vdc
Base–Emitter On Voltage ($I_C = 50\text{ mAdc}, V_{CE} = 5.0\text{ Vdc}$)	$V_{BE(on)}$	—	1.75	Vdc

SMALL–SIGNAL CHARACTERISTICS

Output Capacitance ($V_{CB} = 10\text{ Vdc}, I_E = 0, f = 1.0\text{ MHz}$)	C_{obo}	—	7.0	pF
Input Capacitance ($V_{EB} = 0.5\text{ Vdc}, I_C = 0, f = 1.0\text{ MHz}$)	C_{ibo}	—	15	pF
Current Gain–High Frequency ($V_{CE} = 5.0\text{ Vdc}, I_C = 10\text{ mAdc}, f = 100\text{ MHz}$)	$ h_{fe} $	1.3	—	Vdc
Noise Finure ($V_{CE} = 5.0\text{ Vdc}, I_C = 1.0\text{ mAdc}, R_S = 100\text{ k}\Omega, f = 1.0\text{ kHz}$)	NF	—	10	dB

3. **Pulse Tent:** Pulse Width = 300 μs , Duty Cycle = 2.0%

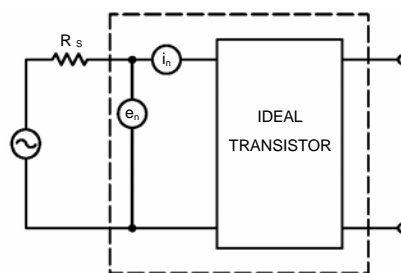

Figure 1. Transistor Noise Model

LMBT6427LT1G

NOISE CHARACTERISTICS

($V_{CE} = 5.0 \text{ Vdc}$, $T_A = 25^\circ\text{C}$)

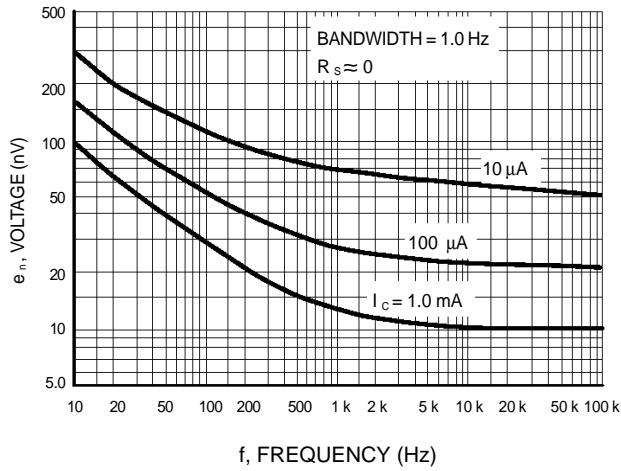

Figure 2. Noise Voltage

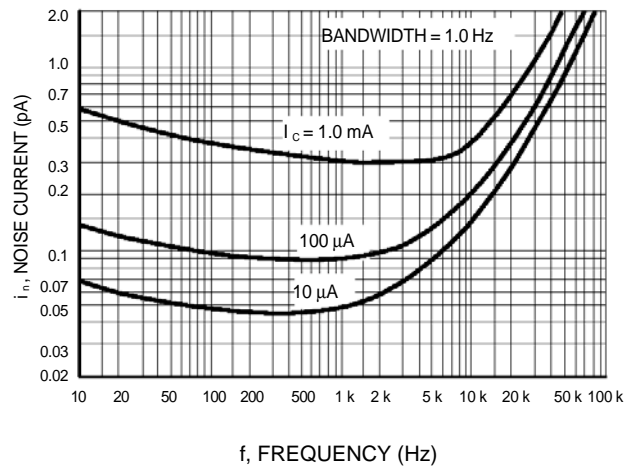

Figure 3. Noise Current

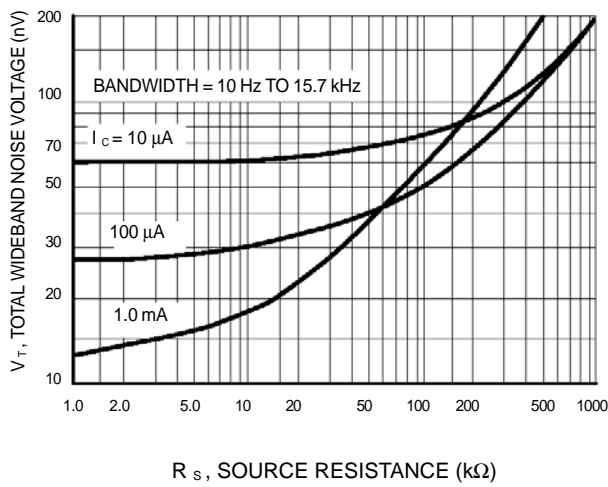

Figure 4. Total Wideband Noise Voltage

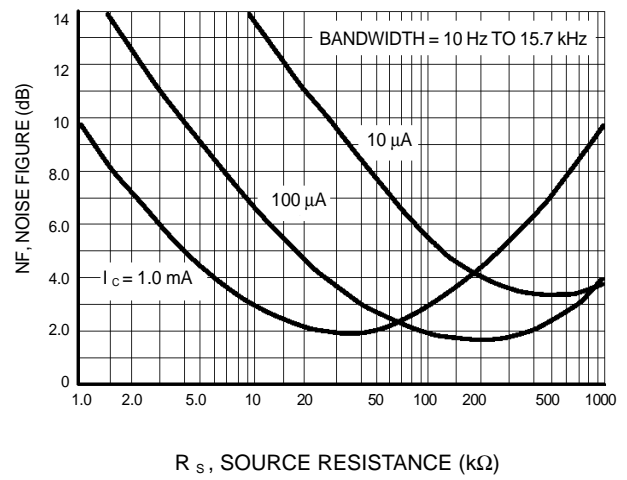

Figure 5. Wideband Noise Figure

LMBT6427LT1G

SMALL-SIGNAL CHARACTERISTICS

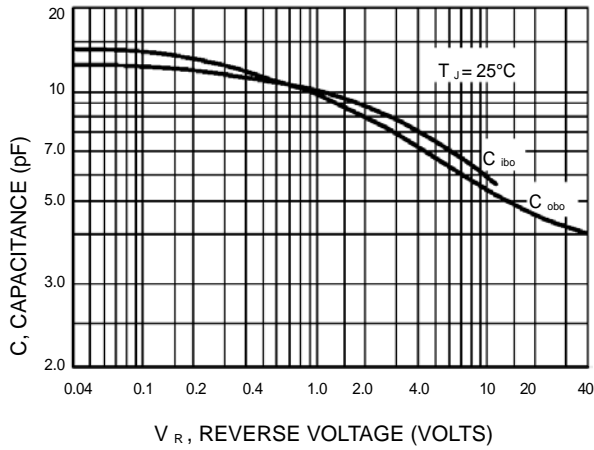

Figure 6. Capacitance

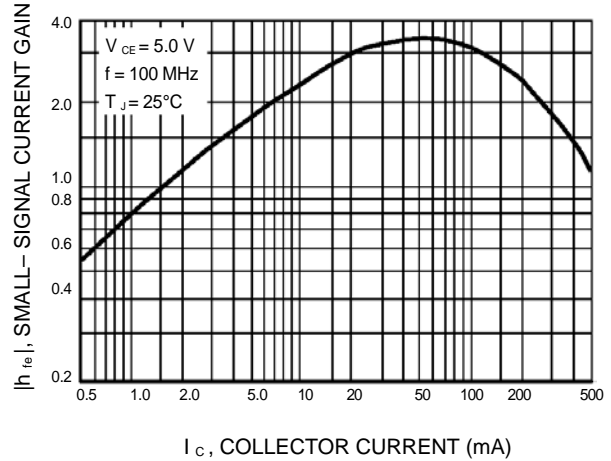

Figure 7. High Frequency Current Gain

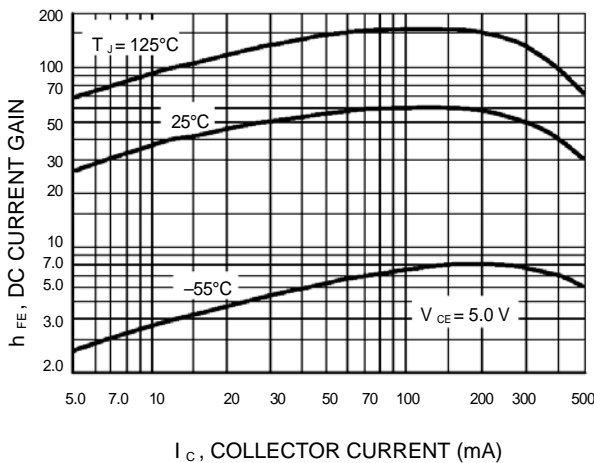

Figure 8. DC Current Gain

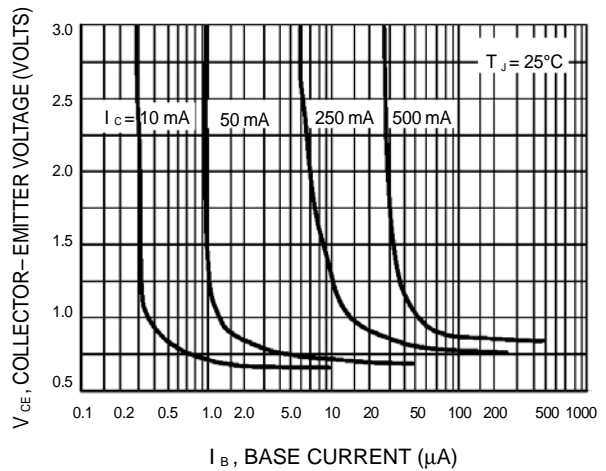

Figure 9. Collector Saturation Region

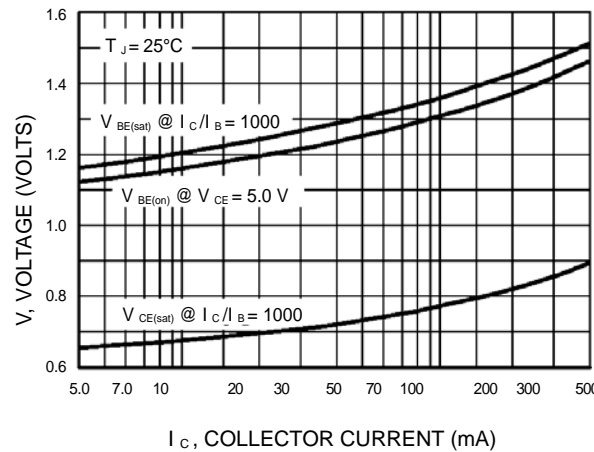

Figure 10. "On" Voltages

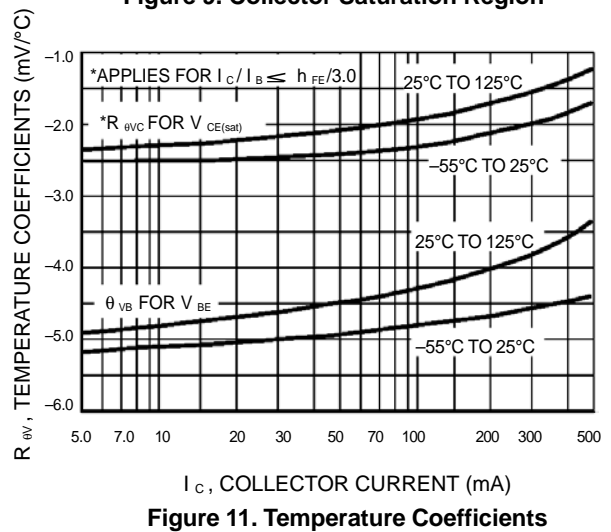

Figure 11. Temperature Coefficients

LMBT6427LT1G

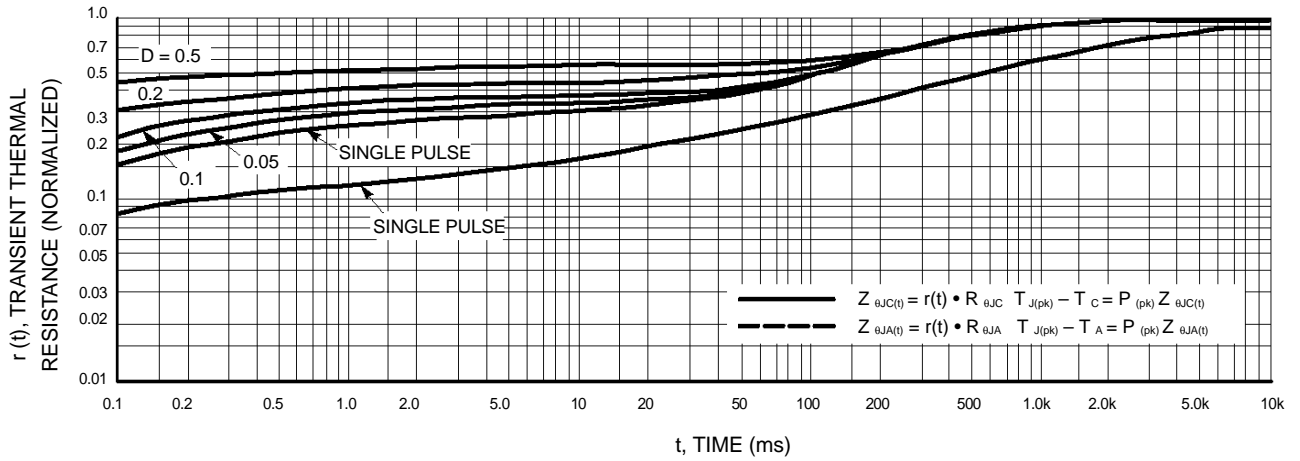
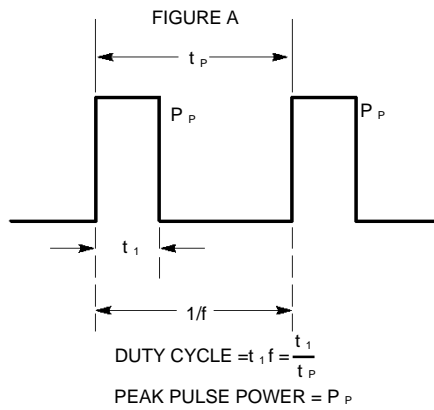

Figure 12. Thermal Response



Design Note: Use of Transient Thermal Resistance Data

LMBT6427LT1G
SOT-23
NOTES:

1. DIMENSIONING AND TOLERANCING PER ANSI Y14.5M,1982
2. CONTROLLING DIMENSION: INCH.

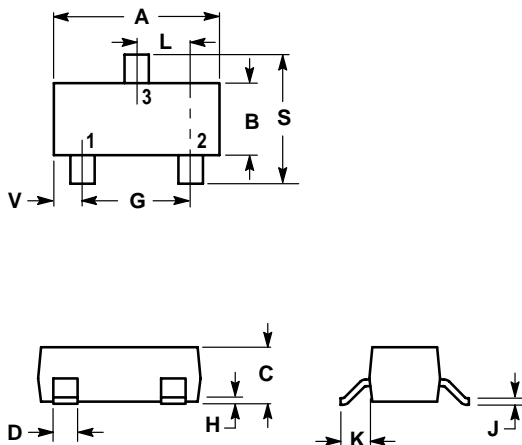

DIM	INCHES		MILLIMETERS	
	MIN	MAX	MIN	MAX
A	0.1102	0.1197	2.80	3.04
B	0.0472	0.0551	1.20	1.40
C	0.0350	0.0440	0.89	1.11
D	0.0150	0.0200	0.37	0.50
G	0.0701	0.0807	1.78	2.04
H	0.0005	0.0040	0.013	0.100
J	0.0034	0.0070	0.085	0.177
K	0.0140	0.0285	0.35	0.69
L	0.0350	0.0401	0.89	1.02
S	0.0830	0.1039	2.10	2.64
V	0.0177	0.0236	0.45	0.60

