

Pin Header 1.27mm SQ Pin=0.4mm 1 Row H=1.0/1.5/2.5mm Right Angle Type

Specifications

Current Rate: 1 AMP
 Insulation Resistance: 1000MΩ Min.
 Contact Resistance: 20mΩ Max.
 Dielectric Voltage: 500V AC for one minute
 Operation Temperature: -40°C to +105°C

Material

Insulator: Polyester, UL 94V-0
 ©Standard: Nylon 6T
 Terminal: Copper Alloy
 Plating: Gold Plated

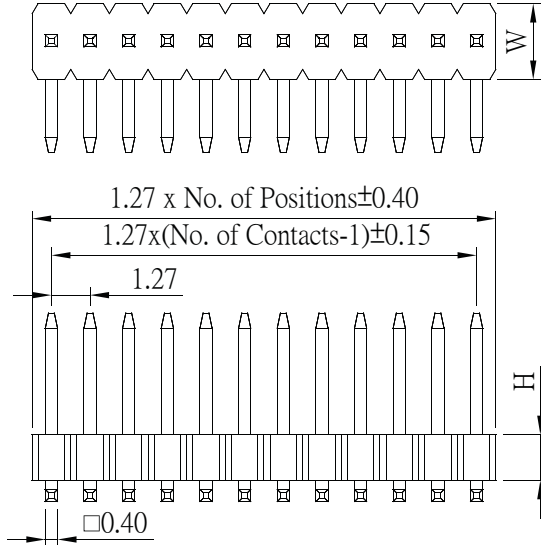
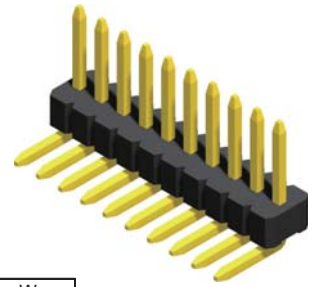

	Dim. C	Dim. W
H=1.0mm	1.50	2.10
H=1.5mm	2.00	2.10
H=2.5mm	3.00	2.50

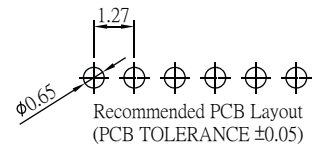
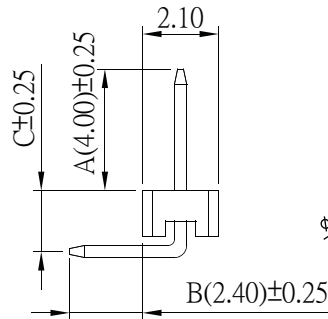

Part No.: PH3R10/15/25-1XX-U

Pin Header 1.27mm SQ Pin=0.4mm 2 Row H=1.0/1.5/1.7/2.0/2.5mm Right Angle Type

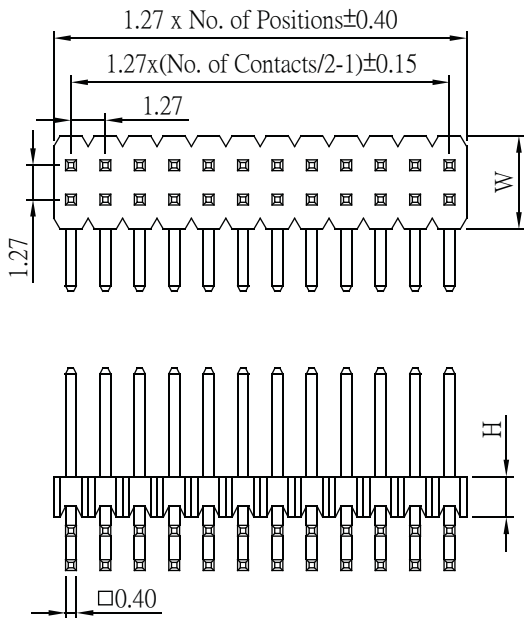

	Dim. C	Dim. W
H=1.0mm	1.50	3.40
H=1.5mm	2.00	3.40
H=1.7mm	2.20	3.00
H=2.0mm	2.50	3.00
H=2.5mm	3.00	3.00

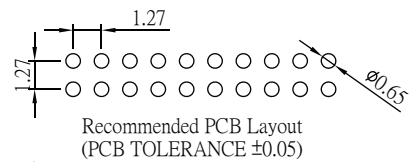
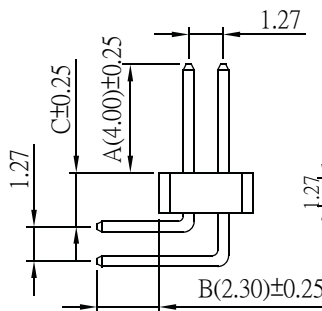

Part No.: PH3R10/15/17/20/25-2XX-U

ORDER INFORMATION

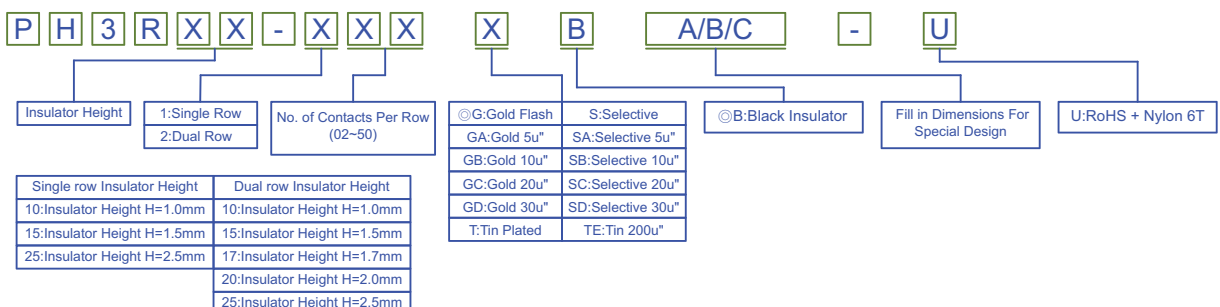

©: Standard Recommended