

APPLICATION MANUAL

LDO REGULATOR WITH ON/OFF SWITCH TK718xxCB

CONTENTS

1 . DESCRIPTION	2
2 . FEATURES	2
3 . APPLICATIONS	2
4 . PIN CONFIGURATION	2
5 . BLOCK DIAGRAM	2
6 . ORDERING INFORMATION	3
7 . ABSOLUTE MAXIMUM RATINGS	3
8 . ELECTRICAL CHARACTERISTICS	4
9 . TEST CIRCUIT	6
10 . APPLICATION EXAMPLE	6
11 . TYPICAL CHARACTERISTICS	7
12 . PIN DESCRIPTION	20
13 . APPLICATIONS INFORMATION	21
14 . NOTES	27
15 . OFFICES	27



LDO REGULATOR WITH ON/OFF SWITCH TK718xxCB

1. DESCRIPTION

The TK718xxCB is LDO regulator in a very small FC-5 package.
 The IC is designed for portable applications with space requirements.
 The IC offers very low dropout voltage.
 The output voltage is internally fixed from 1.5V to 5.0V in 0.1V steps.

2. FEATURES

- Very Small Size : 5 Bump Flip Chip (FC-5)
- Active High On/Off Control
- Very Good Stability : Ceramic capacitor can be used.
 : $C_{OUT} \geq 0.1\mu F$ at $V_{OUT} \geq 2.5V$ and $I_{OUT} \geq 0.5mA$
- High Precision Output Voltage
 $\pm 1.5\%$ or $\pm 50mV$ ($T_A = T_J = 25^\circ C$)
- Excellent Ripple Rejection Ratio : -80dB at 1kHz
- Output Current : 200mA (peak 320mA)
- Very Low Dropout Voltage : 75mV at $I_{OUT} = 50mA$
- Wide Operating Voltage Range : 2.1V~14V
- Very Low Noise with Noise Bypass pin
- Short Circuit Protection (Over Current Protection)
- Internal Thermal Shutdown (Over Heat Protection)
- Reverse Bias Protection

3. APPLICATIONS

- Portable appliances

4. PIN CONFIGURATION

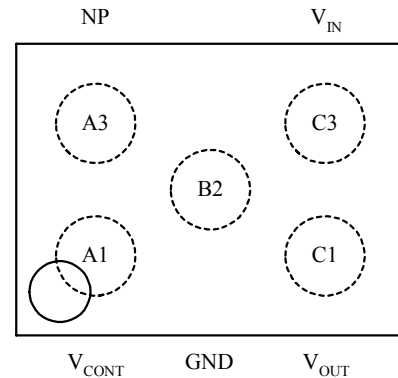

5. BLOCK DIAGRAM

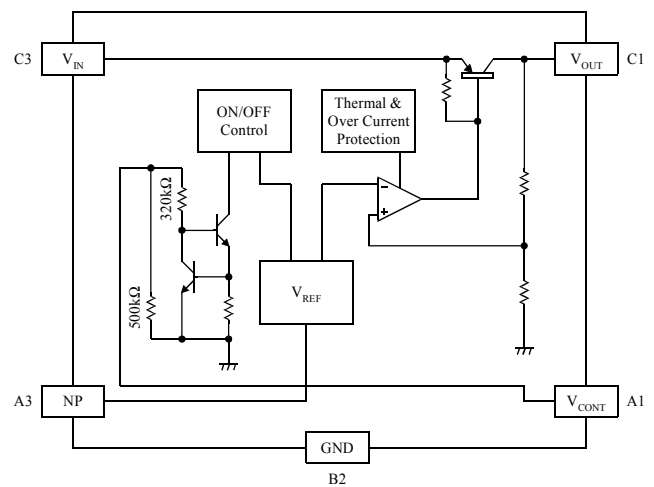

6. ORDERING INFORMATION

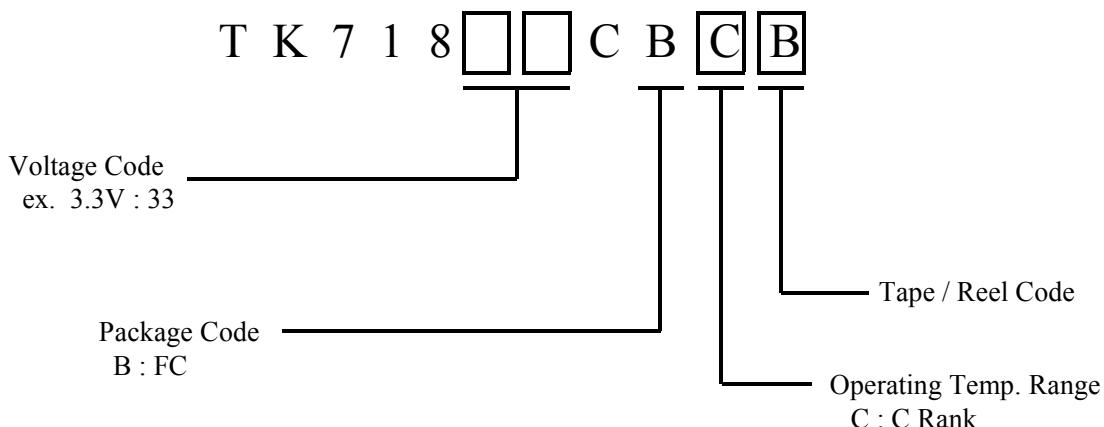

Standard Voltage (Boldface type)

TK71818CB	TK71820CB	TK71825CB	TK71827CB	TK71828CB
TK71829CB	TK71830CB	TK71831CB	TK71833CB	

*Please contact your authorized TOKO representatives for voltage availability.
If you need a voltage other than the value listed in the above table, please contact TOKO.

7. ABSOLUTE MAXIMUM RATINGS

T_A=25°C

Parameter	Symbol	Rating	Units	Conditions
Absolute Maximum Ratings				
Supply Voltage	V _{CC,MAX}	-0.4 ~ 16	V	
Reverse Bias	V _{REV,MAX}	-0.4 ~ 6	V	V _{OUT} ≤ 2.0V
		-0.4 ~ 12	V	V _{OUT} ≥ 2.1V
NP pin Voltage	V _{NP,MAX}	-0.4 ~ 5	V	
Control pin Voltage	V _{CONT,MAX}	-0.4 ~ 16	V	
Storage Temperature Range	T _{STG}	-55 ~ 150	°C	
Power Dissipation	P _D	450 when mounted on PCB	mW	Internal Limited T _J =150°C *
Operating Condition				
Operating Temperature Range	T _{OP}	-40 ~ 85	°C	
Operating Voltage Range	V _{OP}	2.1 ~ 14	V	
Short Circuit Current	I _{SHORT}	360	mA	

* P_D must be decreased at rate of 3.6mW/°C for operation above 25°C.
The maximum ratings are the absolute limitation values with the possibility of damaging the IC.
When the operation exceeds this standard, quality can not be guaranteed.

8. ELECTRICAL CHARACTERISTICS

The parameters with min. or max. values will be guaranteed at $T_A=T_J=25^{\circ}\text{C}$ with test when manufacturing or SQC(Statistical Quality Control) methods. The operation between $-40 \sim 85^{\circ}\text{C}$ is guaranteed by design.

$$V_{IN}=V_{OUT,TYP}+1V, V_{CONT}=1.8V, T_A=T_J=25^{\circ}\text{C}$$

Parameter	Symbol	Value			Units	Conditions
		MIN	TYP	MAX		
Output Voltage	V_{OUT}	Refer to TABLE 1 ~ 2			V	$I_{OUT}=5\text{mA}$
Line Regulation	$L_{IN}R_{EG}$		0.0	5.0	mV	$\Delta V_{IN}=5V$
Load Regulation	$L_{OA}R_{EG}$	Refer to TABLE 1 ~ 2			mV	$I_{OUT}=5\text{mA} \sim 100\text{mA}$
		Refer to TABLE 1 ~ 2			mV	$I_{OUT}=5\text{mA} \sim 200\text{mA}$
Dropout Voltage *1	V_{DROP}		75	130	mV	$I_{OUT}=50\text{mA}$
			110	195	mV	$I_{OUT}=100\text{mA}$
			210	320	mV	$I_{OUT}=180\text{mA}$ ($2.1V \leq V_{OUT} \leq 2.3V$)
			180	320	mV	$I_{OUT}=200\text{mA}$ ($V_{OUT} \geq 2.4V$)
Maximum Output Current *2	$I_{OUT,MAX}$	240	320		mA	When ($V_{OUT,TYP} \times 0.9$)
Quiescent Current	I_Q		63	100	μA	$I_{OUT}=0\text{mA}$
Standby Current	$I_{STANDBY}$		0.0	0.1	μA	$V_{CONT}=0V$
Ground Pin Current	I_{GND}		1.0	1.8	mA	$I_{OUT}=50\text{mA}$
Control Terminal *3						
Control Current	I_{CONT}		5.0	15.0	μA	$V_{CONT}=1.8V$
Control Voltage	V_{CONT}	1.8			V	V_{OUT} ON state
				0.35	V	V_{OUT} OFF state
Reference Value						
Np Terminal Voltage	V_{NP}		1.28		V	
Output Voltage / Temp.	V_{OUT}/T_A		35		ppm/ $^{\circ}\text{C}$	
Output Noise Voltage (TK71830CB)	V_{NOISE}		38		μV_{rms}	$C_{OUT}=1.0\mu\text{F}, C_{NP}=0.01\mu\text{F}$ $I_{OUT}=30\text{mA}$
Ripple Rejection (TK71830CB)	RR		80		dB	$C_{OUT}=1.0\mu\text{F}, C_{NP}=0.01\mu\text{F}$ $I_{OUT}=10\text{mA}, 1\text{kHz}$
Rise Time (TK71830CB)	t_r		30		μs	$C_{OUT}=1.0\mu\text{F}, C_{NP}=0.001\mu\text{F}$ V_{CONT} : Pulse Wave (100Hz) V_{CONT} ON $\rightarrow V_{OUT} \times 95\%$ point

*1: For $V_{OUT} \leq 2.0V$, not guaranteed.

*2: The maximum output current is limited by power dissipation.

*3: The input current decreases to the pA level by connecting the control terminal to GND (Off state).

General Note : Parameters with only typical values are just reference. (Not guaranteed)

General Note : It is possible to decrease the output noise voltage by connecting a capacitor with the noise bypass pin (NP). The noise level is dependent on the capacitance and capacitor characteristic.

TABLE 1.Preferred Product

Part Number	Output Voltage			Load Regulation			
				I _{OUT} = 100mA		I _{OUT} = 200mA	
	MIN	TYP	MAX	TYP	MAX	TYP	MAX
	V	V	V	mV	mV	mV	mV
TK71820CBC	1.950	2.000	2.050	5	11	12	27
TK71828CBC	2.750	2.800	2.850	6	13	15	35
TK71829CBC	2.850	2.900	2.950	6	14	15	36
TK71830CBC	2.950	3.000	3.050	6	14	15	36
TK71833CBC	3.250	3.300	3.350	6	15	17	39

TABLE 2.Limited Availability Product

Part Number	Output Voltage			Load Regulation			
				I _{OUT} = 100mA		I _{OUT} = 200mA	
	MIN	TYP	MAX	TYP	MAX	TYP	MAX
	V	V	V	mV	mV	mV	mV
TK71818CBC	1.750	1.800	1.850	5	10	11	25
TK71825CBC	2.450	2.500	2.550	5	12	14	32
TK71827CBC	2.650	2.700	2.750	6	13	14	34
TK71831CBC	3.050	3.100	3.150	6	14	16	37

Notice.

Please contact your authorized TOKO representative for voltage availability.
 If you need a voltage other than the value listed in the above table, please contact TOKO.

9. TEST CIRCUIT

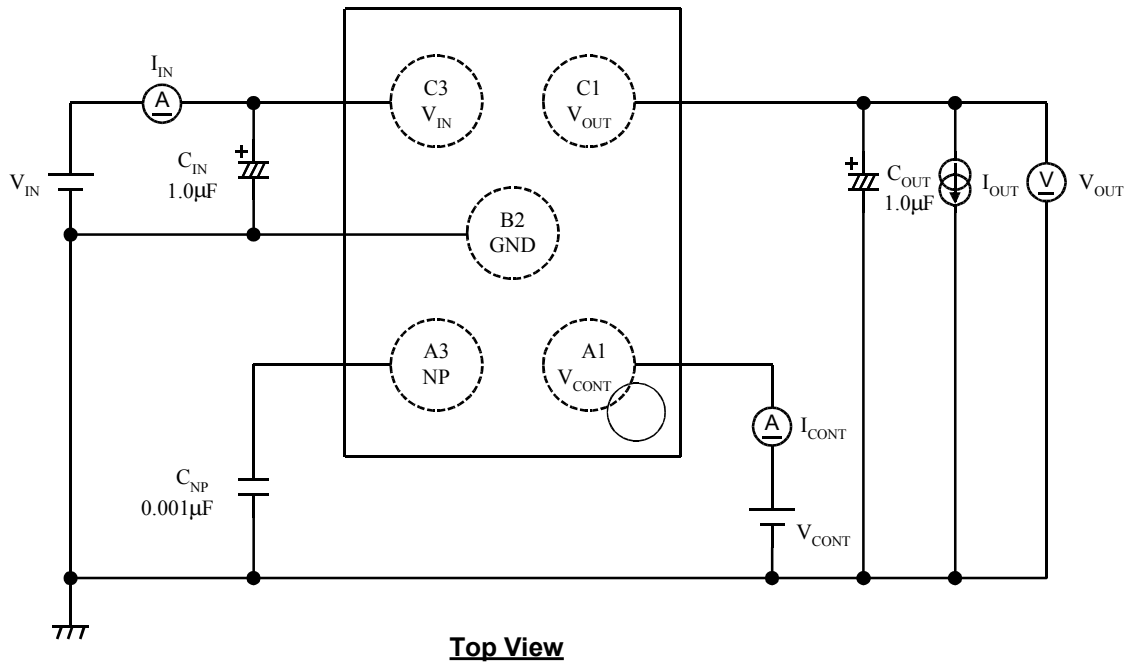

Notice.

The limit value of electrical characteristics is applied when $C_{IN}=1.0\mu\text{F}$ (Tantalum), $C_{OUT}=1.0\mu\text{F}$ (Tantalum), $C_{NP}=0.001\mu\text{F}$ (Ceramic).
 But C_{IN} , C_{OUT} , and C_{NP} can be either ceramic or tantalum capacitors (at $I_{OUT}\geq 0.5\text{mA}$).

10. APPLICATION EXAMPLE

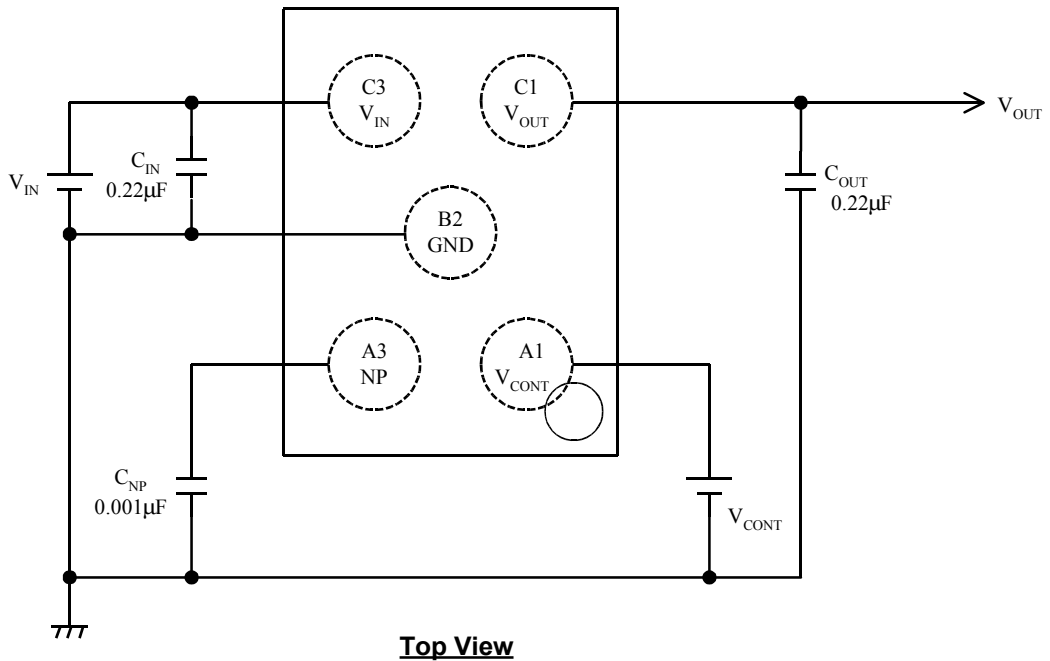

11. TYPICAL CHARACTERISTICS

11-1-1. DC CHARACTERISTICS (TK71828CB)

Line Regulation

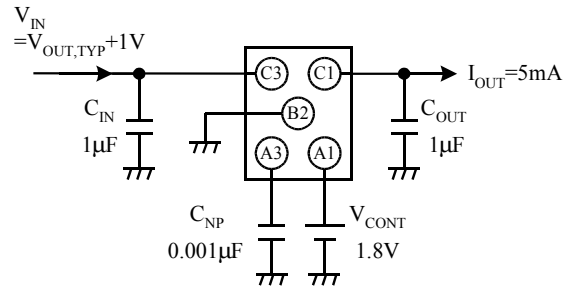
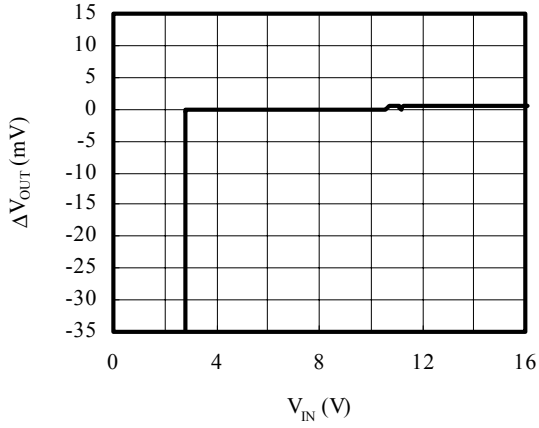

V_{IN} vs I_{IN}

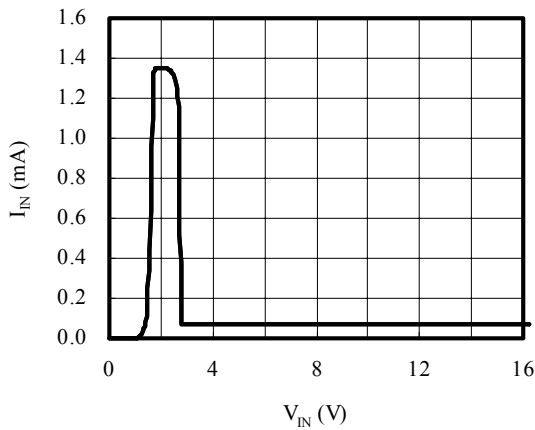

V_{IN} vs I_{IN}

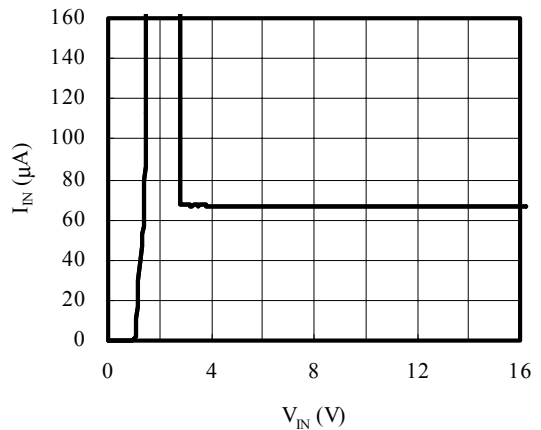

Load Regulation

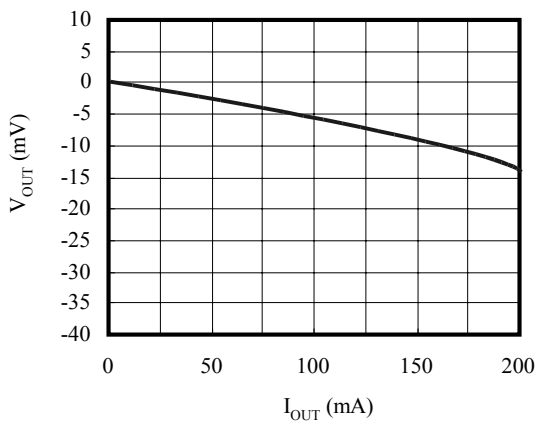

I_{OUT} vs V_{OUT}

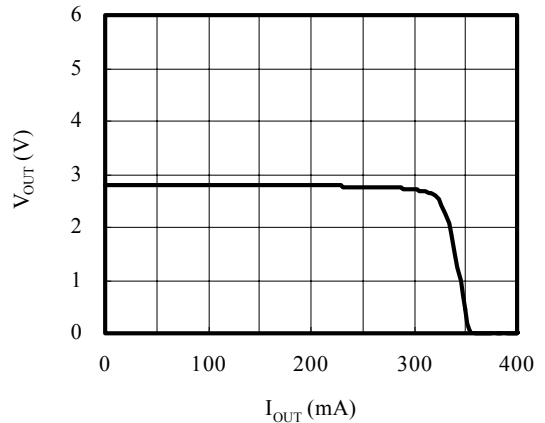

■ Reverse Bias Current

$V_{IN}=0V, V_{CONT}=0V$

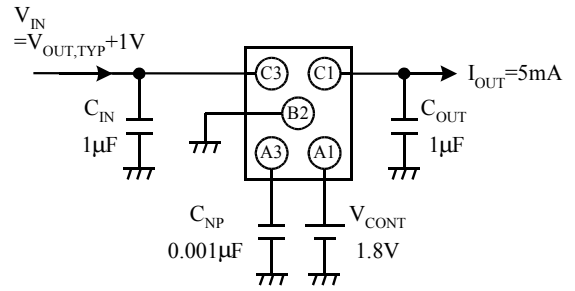
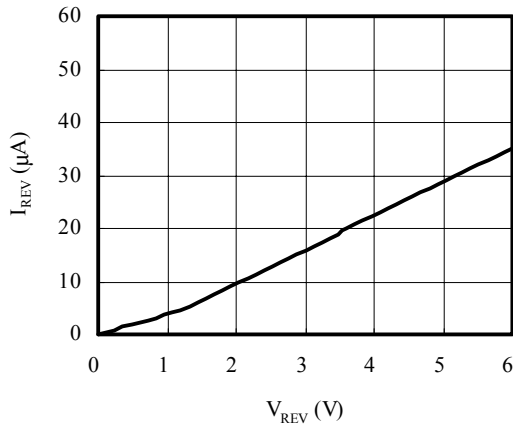

■ Dropout Voltage

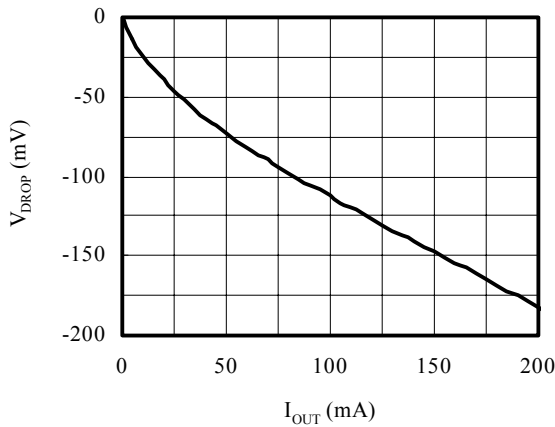

■ V_{IN} vs V_{OUT} Regulation Point

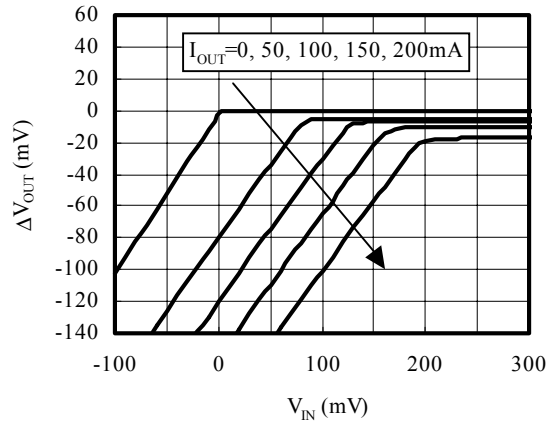

■ V_{IN} vs I_{IN} (Off state)

$V_{CONT}=0V$

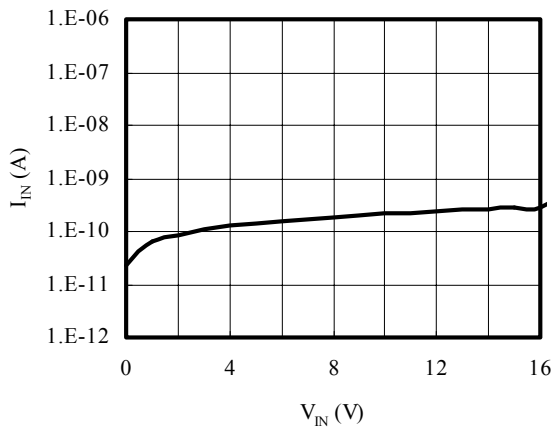

■ V_{CONT} vs I_{CONT}

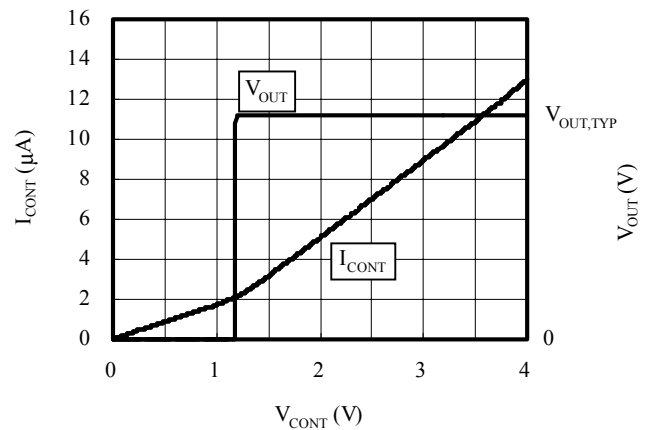

■ Ground Pin Current

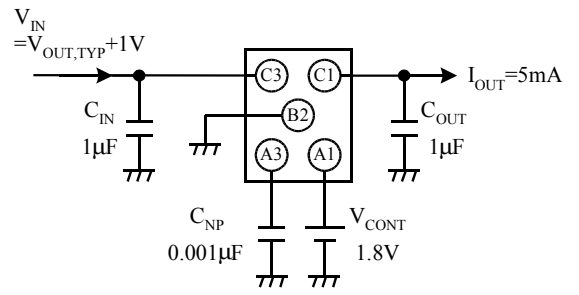
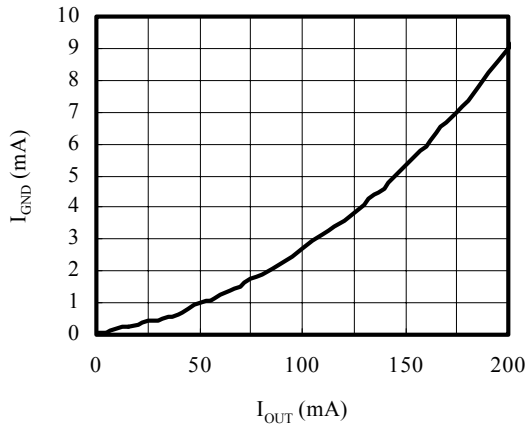

11-1-2. Temperature Characteristics

■ V_{OUT}

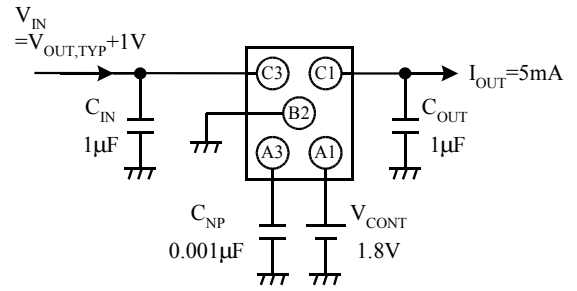
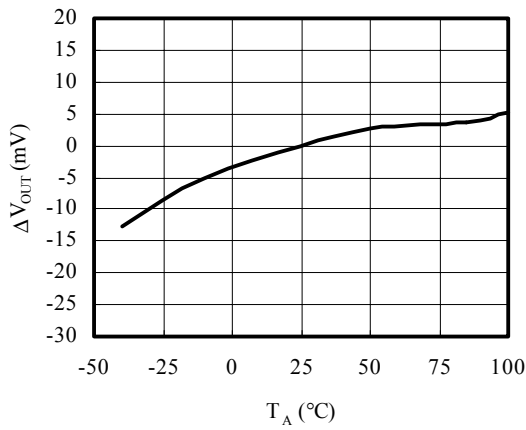

■ $I_{OUT MAX}$

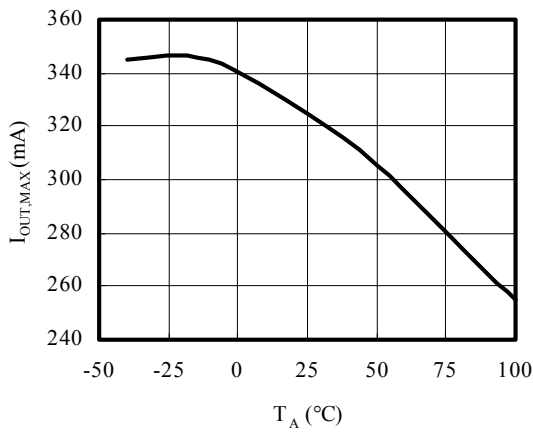

■ Ground Pin Current

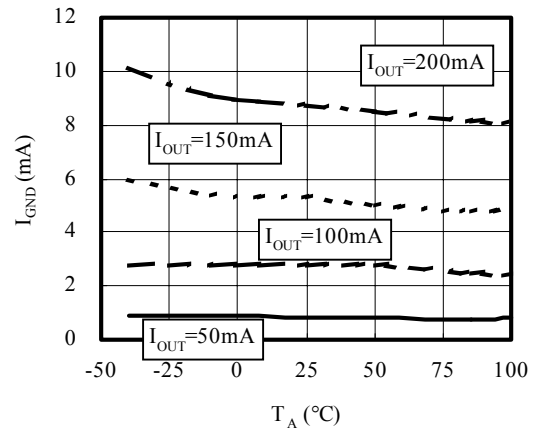

■ Control Current

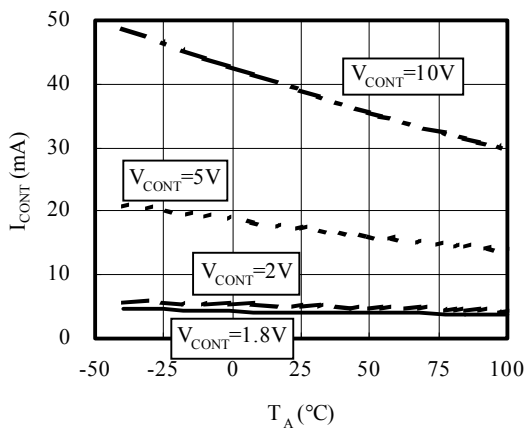

■ ON/OFF Point

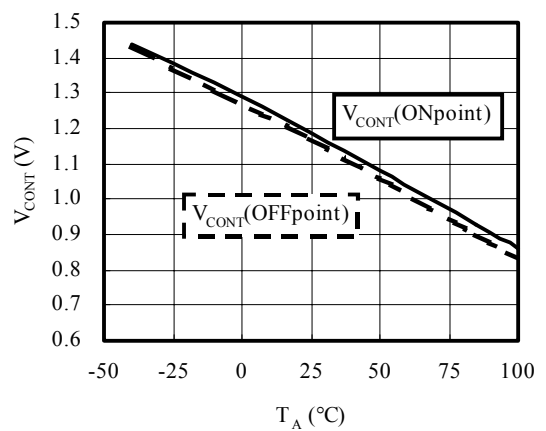

■ Dropout Voltage

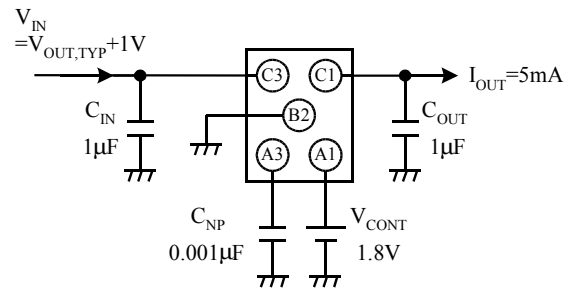
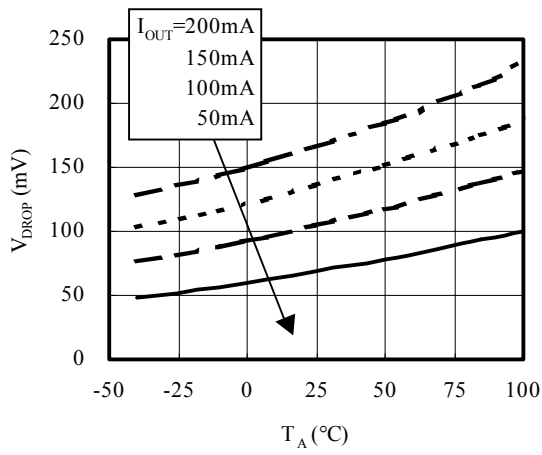

■ I_{IN}

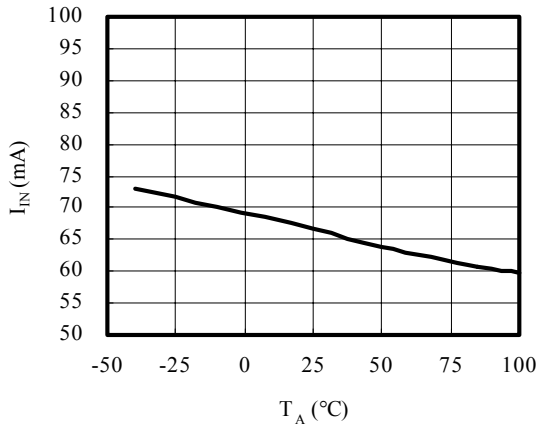

11-2. AC CHARACTERISTICS (TK71828CB)

Ripple Rejection

■ $C_{OUT}=1\mu F$: Ceramic (C) , Tantalum (T)

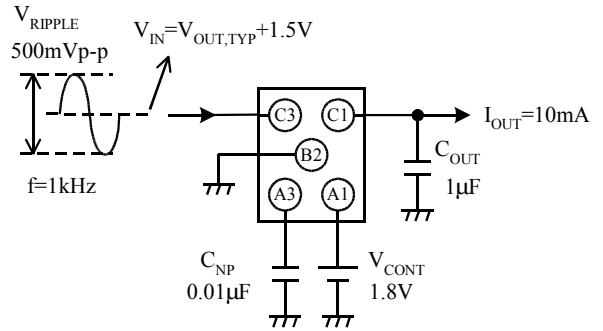
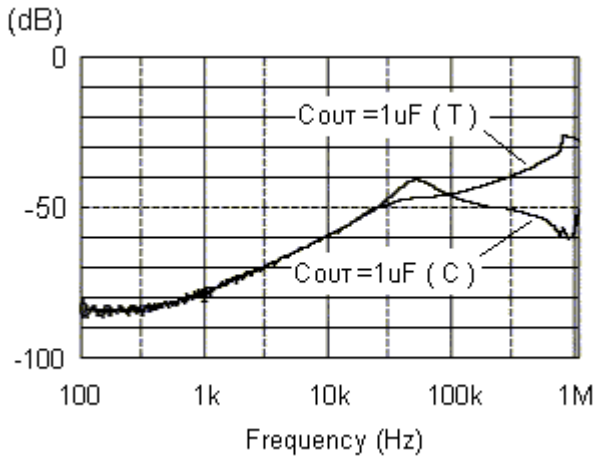

■ $C_{OUT}=0.22\mu F$: Ceramic (C) , Tantalum (T)

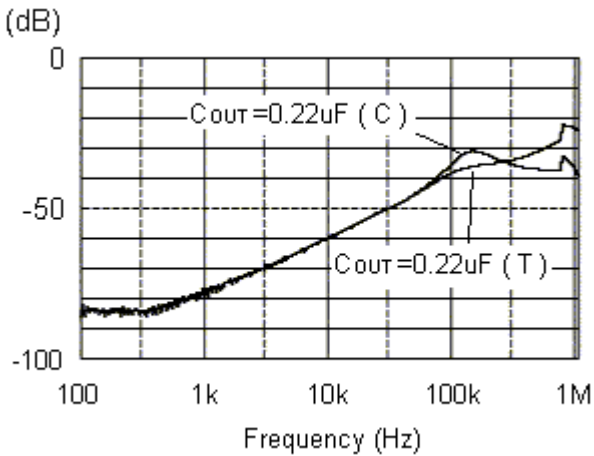

■ $C_{NP}=0.001\mu F, 0.01\mu F$

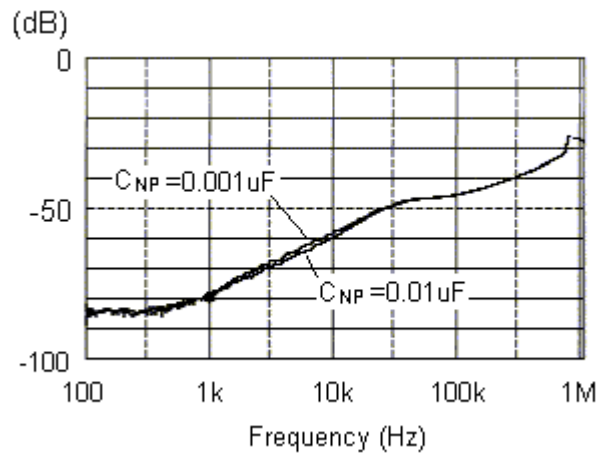

■ $I_{OUT}=10mA, 100mA$

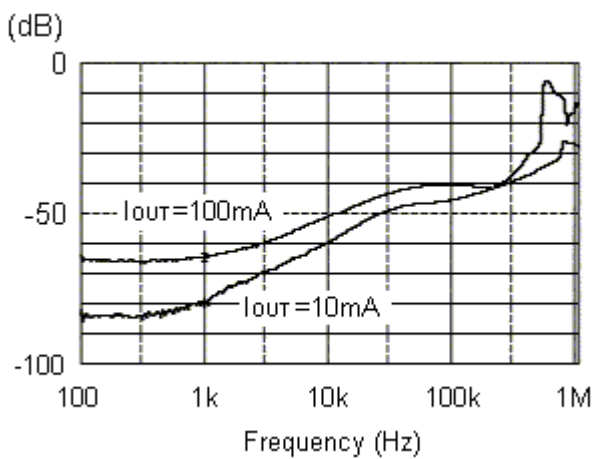

■ I_{OUT} vs RR

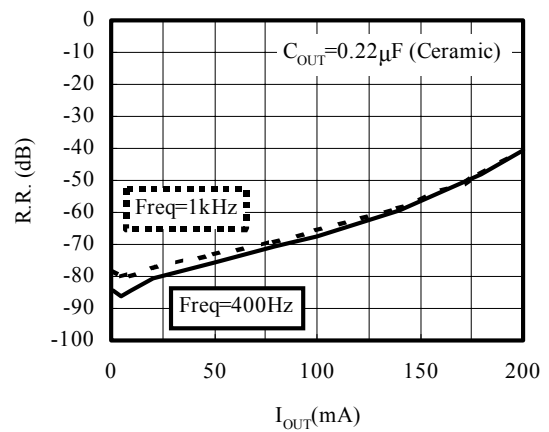

■ Low V_{IN} vs RR

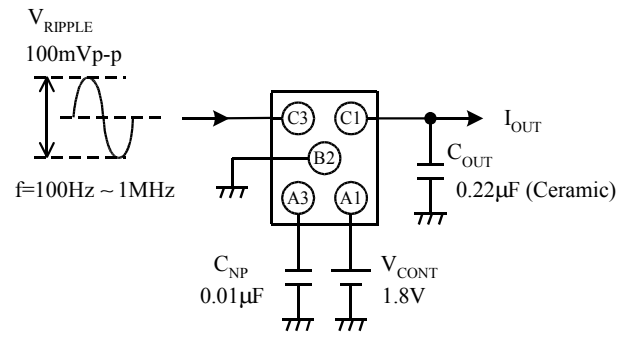
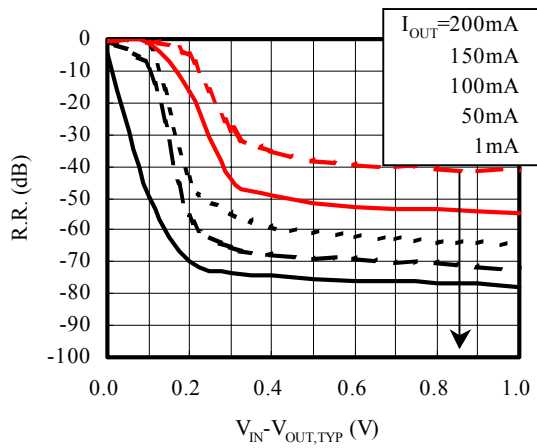

The ripple rejection (R.R) characteristic depends on the characteristic and the capacitance value of the capacitor connected to the output side. The R.R characteristic of 50kHz or more varies greatly with the capacitor on the output side and PCB pattern. If necessary, please confirm stability while operating.

ON/OFF Transient

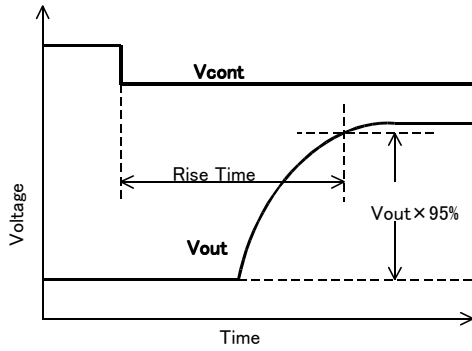

■ $C_{OUT}=0.22\mu\text{F}, 1.0\mu\text{F}, 2.2\mu\text{F}$

■ $C_{OUT}=0.22\mu\text{F}, 1.0\mu\text{F}, 2.2\mu\text{F}$

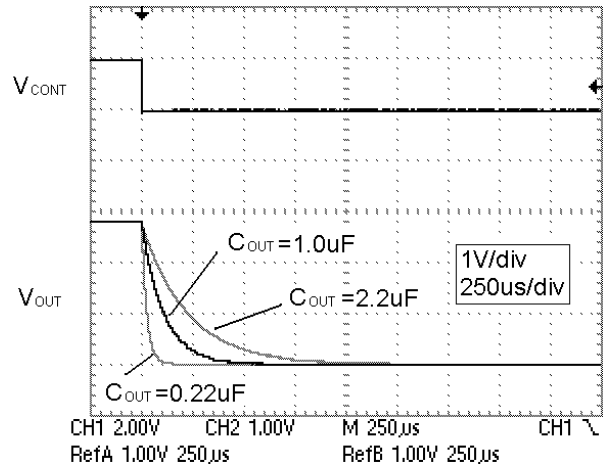
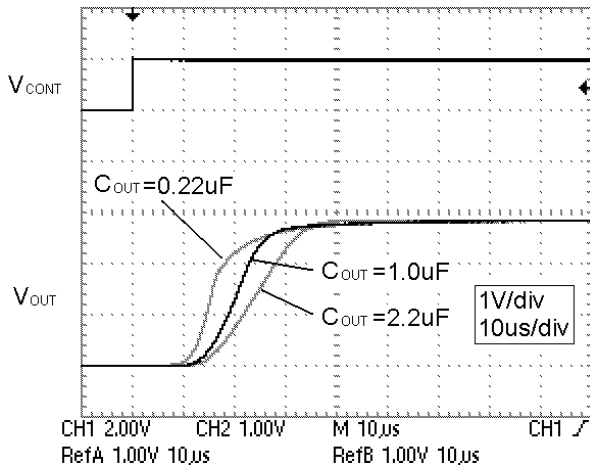

■ $C_{NP}=0.001\mu\text{F}, 0.01\mu\text{F}, 0.1\mu\text{F}$

■ $C_{NP}=100\text{pF}, 0.001\mu\text{F}, 0.01\mu\text{F}$

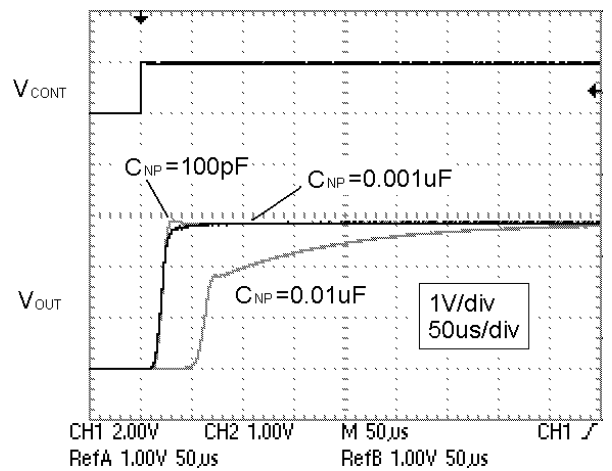
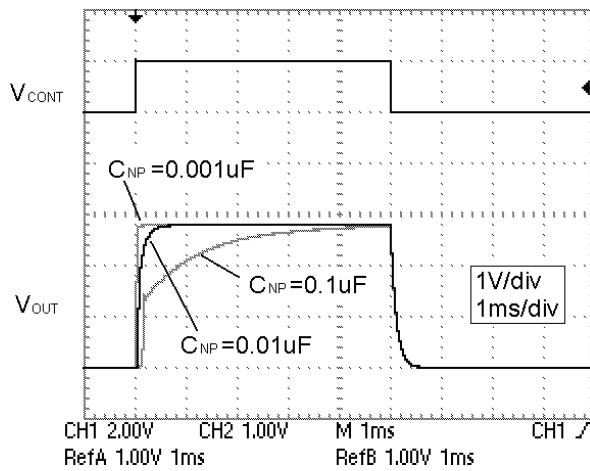

The rise time of the regulator depends on C_{OUT} and C_{NP} .
The fall time depends on C_{OUT} .

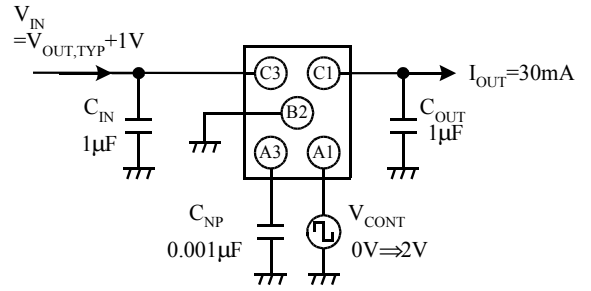

- $C_{OUT}=0.22\mu\text{F}, 1.0\mu\text{F}, 2.2\mu\text{F}$
 V_{CONT} : one pulse (after discharge C_{NP}, C_{OUT})

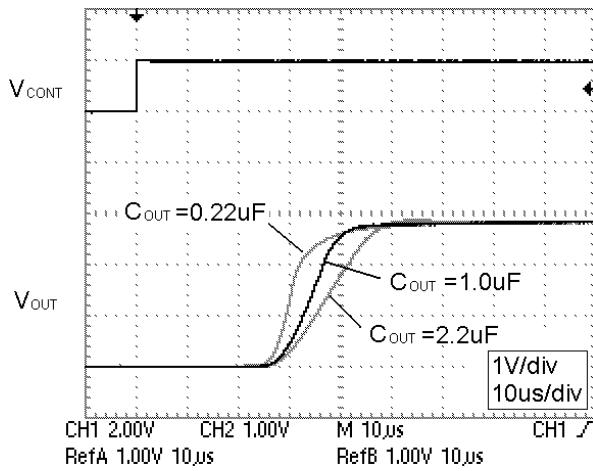

- $C_{NP}=100\text{pF}, 0.001\mu\text{F}, 0.01\mu\text{F}$
 V_{CONT} : one pulse (after discharge C_{NP}, C_{OUT})

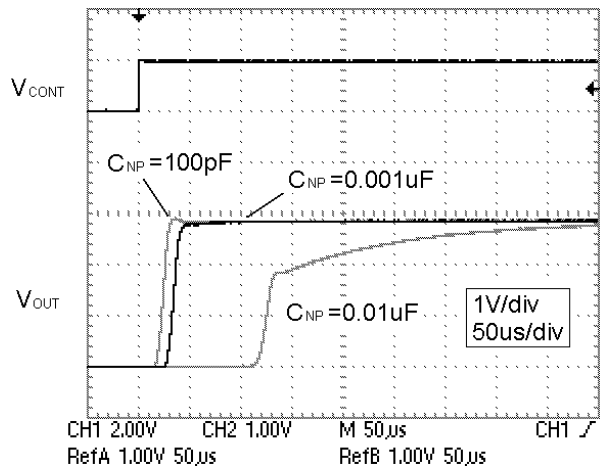

LOAD Transient

■ $C_{OUT}=0.22\mu\text{F}, 1.0\mu\text{F}, 2.2\mu\text{F}, I_{OUT}=5\leftrightarrow 35\text{mA}$

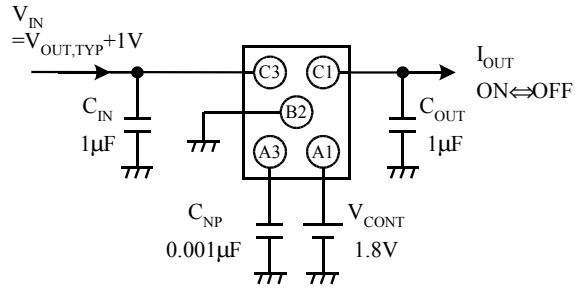
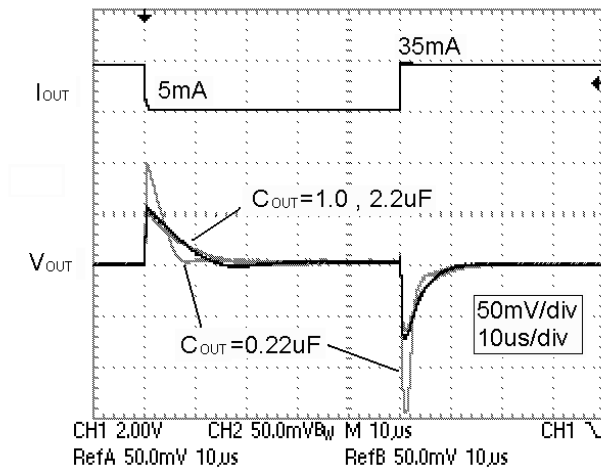

■ $I_{OUT}=0\leftrightarrow 30\text{mA}, 5\leftrightarrow 35\text{mA}$

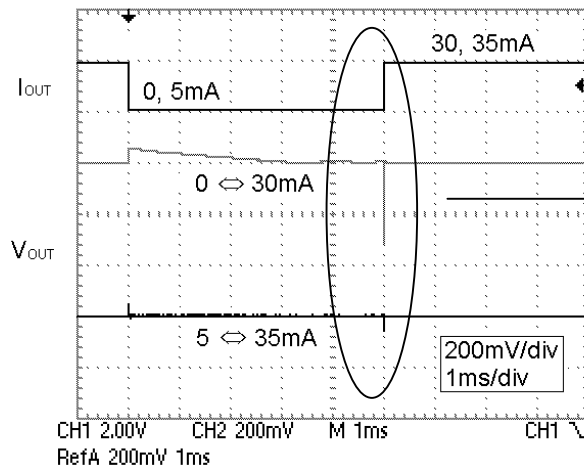

■ $I_{OUT}=0\Rightarrow 30\text{mA}, 5\Rightarrow 35\text{mA}$

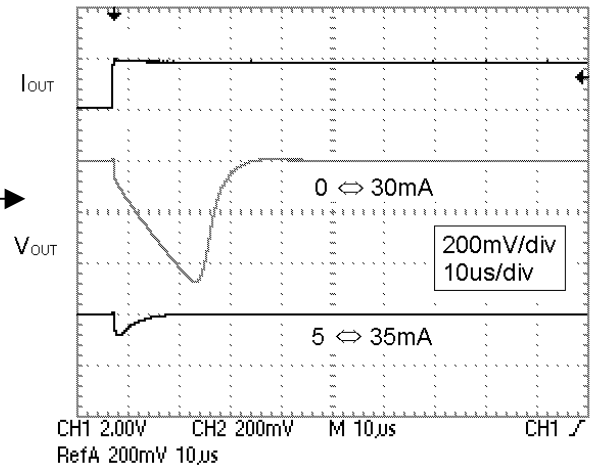

The output load transient characteristics can be greatly improved by adding a small load current to ground. (Refer to the above data curve)

Increase the output capacitance C_{OUT} when the load current change is fast and/or large.

LINE Transient

- $C_{OUT}=0.22\mu\text{F}, 1.0\mu\text{F}, 2.2\mu\text{F}$

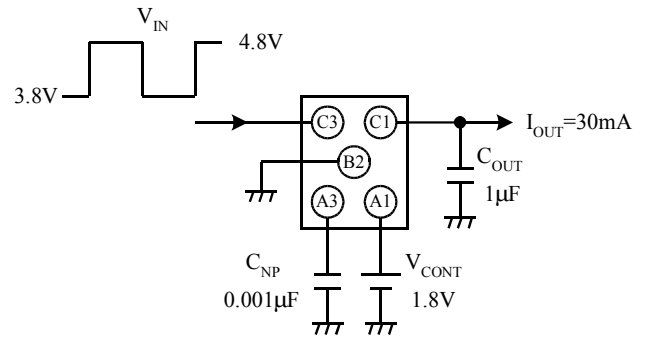
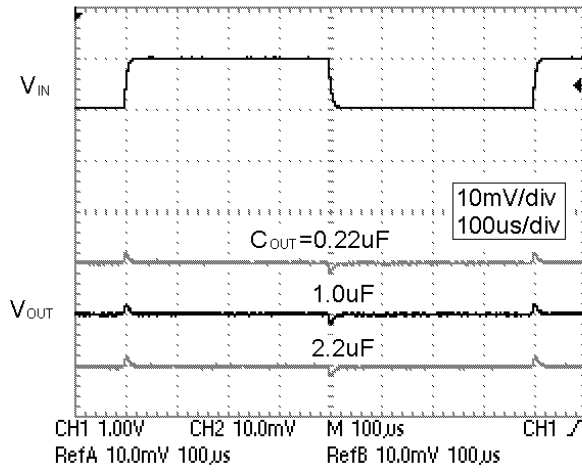

- $C_{NP}=100\text{pF}, 0.001\mu\text{F}, 0.01\mu\text{F}$

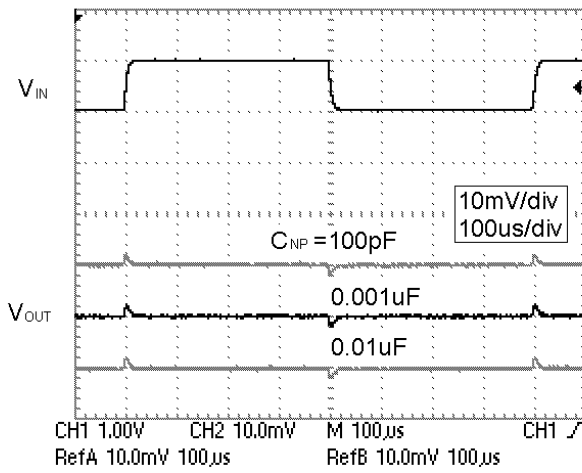

Output Noise Characteristics

■ V_{OUT} vs Noise (C_{OUT} : Tantalum)

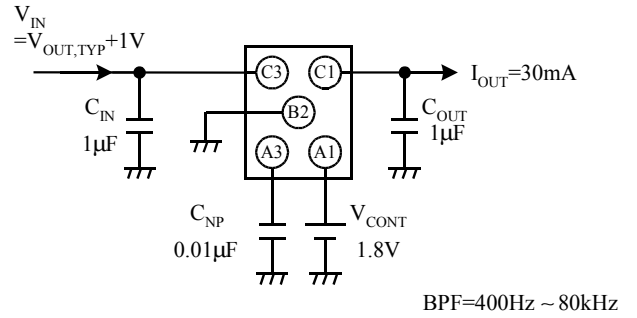
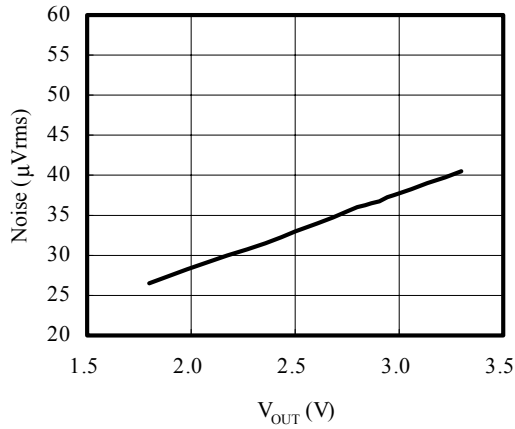

■ C_{NP} vs Noise (C_{OUT} : Tantalum)

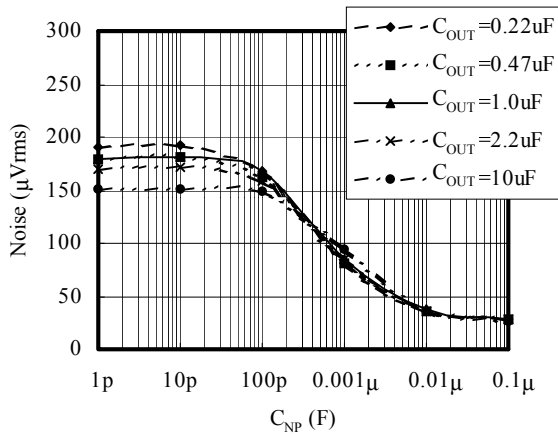

■ C_{NP} vs Noise (C_{OUT} : Ceramic)

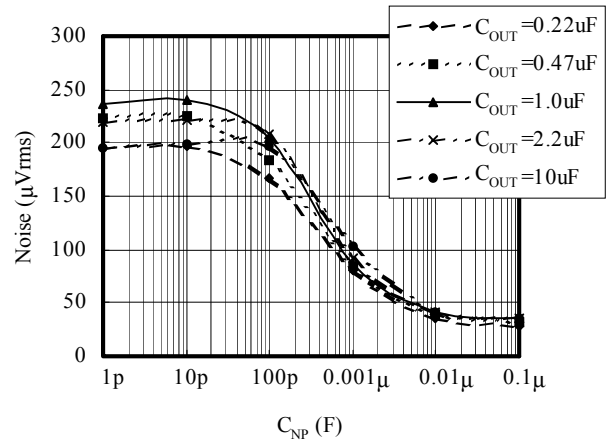

■ I_{OUT} vs Noise (C_{OUT} : Tantalum)

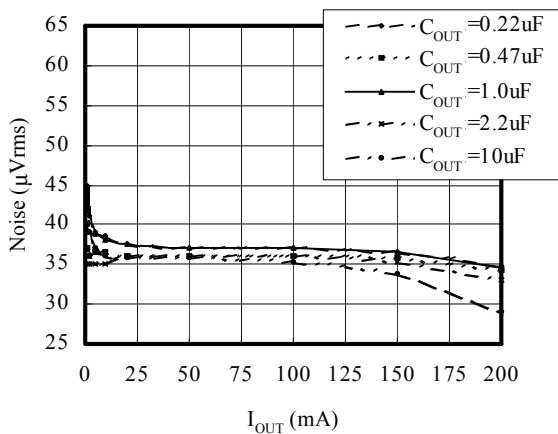

■ I_{OUT} vs Noise (C_{OUT} : Ceramic)

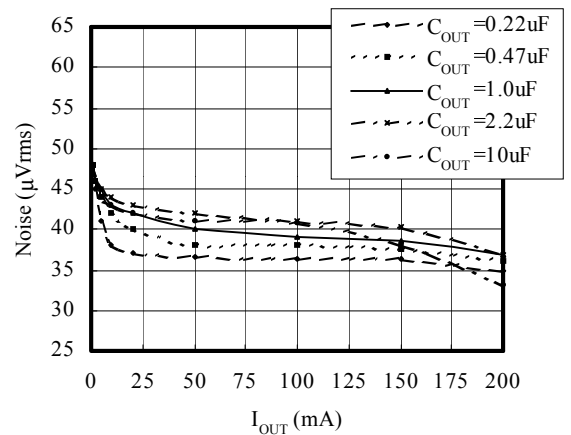

■ Frequency vs Noise

$C_{OUT}=0.22\mu\text{F}$ (Ceramic), $I_{OUT}=10\text{mA}$

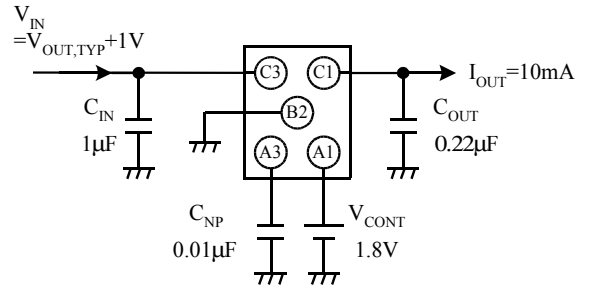
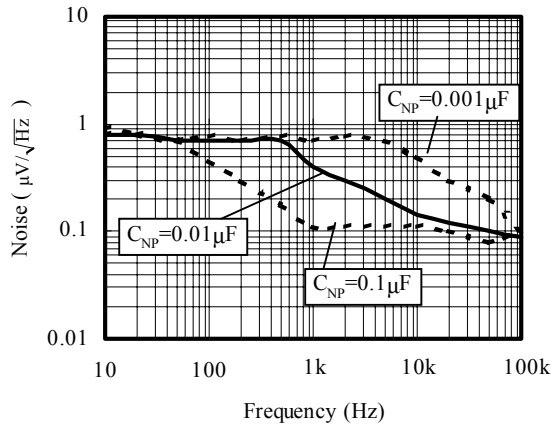

For better noise reduction, it is more effective to increase noise bypass capacitance C_{NP} without increasing output capacitance C_{OUT} . The amount of noise increases with higher output voltages.

12. PIN DESCRIPTION

Pin No.	Pin Description	Internal Equivalent Circuit	Description
A1	V_{CONT}		<p>On/Off Control Terminal</p> <p>$V_{CONT} > 1.8V$: ON $V_{CONT} < 0.35V$: OFF</p> <p>The pull-down resistor (500kΩ) is built-in.</p>
A3	NP		<p>Noise Bypass Terminal</p> <p>Connect a bypass capacitor between GND.</p>
B2	GND		GND Terminal
C1	V_{OUT}		Output Terminal
C3	V_{IN}		Input Terminal

13. APPLICATIONS INFORMATION

13-1. Stability

Linear regulators require input and output capacitors in order to maintain the regulator's loop stability. If a 0.1μF capacitor is connected to the output side, the IC provides stable operation at any voltage in the practical current region.

The equivalent series resistance (ESR) of the output capacitor must be in the stable operation area. However, it is recommended to use as large a value of capacitance as is practical. The output noise and the ripple noise decrease as the capacitance value increases. ESR values vary widely between ceramic and tantalum capacitors. However, tantalum capacitors are assumed to provide more ESR damping resistance, which provides greater circuit stability. This implies that a higher level of circuit stability can be obtained by using tantalum capacitors when compared to ceramic capacitors with similar values.

A recommended value of the application is as follows.

$$C_{IN}=C_{OUT} \geq 0.22\mu\text{F at } I_{OUT} \geq 0.5\text{mA}$$

Fig.13-1.

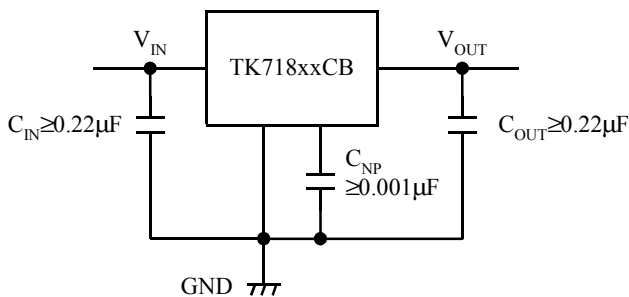

The input capacitor is necessary when the battery is discharged, the power supply impedance increases, or the line distance to the power supply is long.

This capacitor might be necessary on each individual IC even if two or more regulator ICs are used. It is not possible to determine this indiscriminately. Please confirm the stability while mounted

Fig.13-2. Output Voltage, Output Current vs. Stable Operation Area

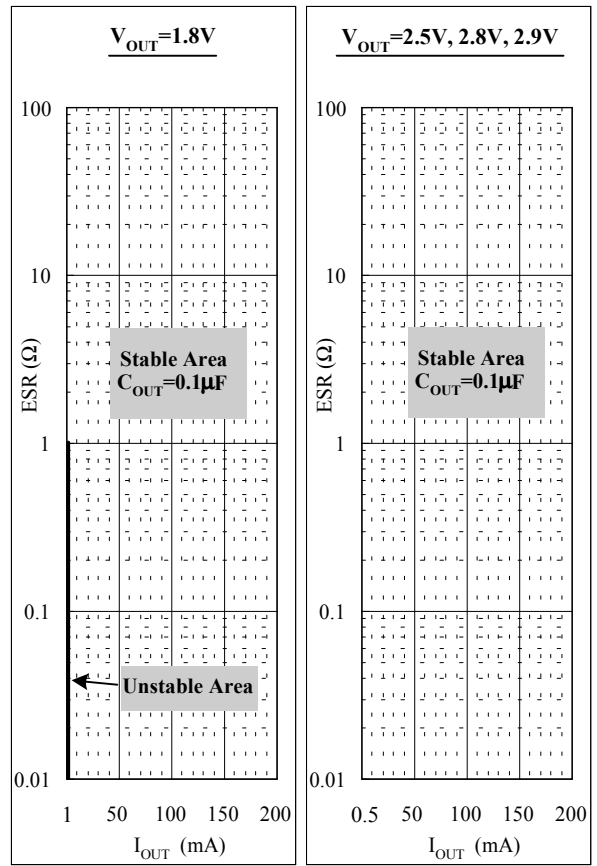
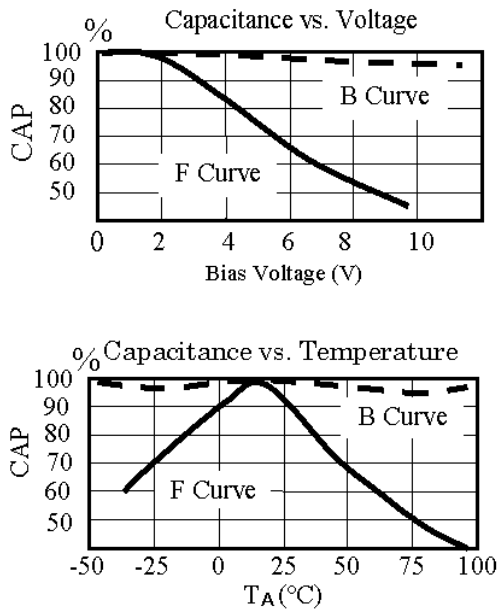

Fig.13-2 shows stable operation with a ceramic capacitor of 0.1μF (excluding the low current region). If the capacitance is not increased in the low voltage, low current area, stable operation may not be achieved. Please select the best output capacitor according to the voltage and current used. The stability of the regulator improves if a big output side capacitor is used (the stable operation area extends.) Please use as large a capacitance as is practical.

For evaluation

- Kyocera : CM05B104K10AB , CM05B224K10AB , CM105B104K16A , CM105B224K16A , CM21B225K10A
- Murata : GRM36B104K10 , GRM42B104K10 , GRM39B104K25 , GRM39B224K10 , GRM39B105K6.3

Fig.13-3. ex. Ceramic Capacitance vs. Voltage, Temperature



Generally, a ceramic capacitor has both a temperature characteristic and a voltage characteristic. Please consider both characteristics when selecting the part. The B curves are the recommend characteristics.

13-2. Definition of term

◆ **Output Voltage (V_{OUT})**

The output voltage is specified with $V_{IN}=(V_{OUT,TYP}+1V)$ and $I_{OUT}=5mA$.

◆ **Maximum Output Current ($I_{OUT,MAX}$)**

The rated output current is specified under the condition where the output voltage drops 0.9V times the value specified with $I_{OUT}=5mA$. The input voltage is set to $V_{OUT,TYP}+1V$ and the current is pulsed to minimize temperature effect.

◆ **Dropout Voltage (V_{DROP})**

The dropout voltage is the difference between the input voltage and the output voltage at which point the regulator starts to fall out of regulation. Below this value, the output voltage will fall as the input voltage is reduced. It is dependent upon the load current and the junction temperature.

◆ **Line Regulation ($L_{IN}R_{EG}$)**

Line regulation is the ability of the regulator to maintain a constant output voltage as the input voltage changes. The line regulation is specified as the input voltage is changed from $V_{IN}=V_{OUT,TYP}+1V$ to $V_{IN}=V_{OUT,TYP}+6V$. It is a pulse measurement to minimize temperature effect.

◆ **Load Regulation ($L_{OA}R_{EG}$)**

Load regulation is the ability of the regulator to maintain a constant output voltage as the load current changes. It is a pulsed measurement to minimize temperature effects with the input voltage set to $V_{IN}=V_{OUT,TYP}+1V$. The load regulation is specified under an output current step condition of 5mA to 100mA.

◆ **Ripple Rejection (R.R)**

Ripple rejection is the ability of the regulator to attenuate the ripple content of the input voltage at the output. It is specified with 500mVrms, 1kHz super-imposed on the input voltage, where $V_{IN}=V_{OUT,TYP}+1.5V$. Ripple rejection is the ratio of the ripple content of the output vs. input and is expressed in dB.

◆ **Standby Current ($I_{STANDBY}$)**

Standby current is the current which flows into the regulator when the output is turned off by the control function ($V_{CONT}=0V$).

◆ **Over Current Sensor**

The over current sensor protects the device when there is excessive output current. It also protects the device if the output is accidentally connected to ground.

◆ **Thermal Sensor**

The thermal sensor protects the device in case the junction temperature exceeds the safe value ($T_J=150^{\circ}C$). This temperature rise can be caused by external heat, excessive power dissipation caused by large input to output voltage drops, or excessive output current. The regulator will shut off when the temperature exceeds the safe value. As the junction temperatures decrease, the regulator will begin to operate again. Under sustained fault conditions, the regulator output will oscillate as the device turns off then resets. Damage may occur to the device under extreme fault.

Please prevent the loss of the regulator when this protection operates, by reducing the input voltage or providing better heat efficiency.

◆ **Reverse Voltage Protection**

Reverse voltage protection prevents damage due to the output voltage being higher than the input voltage. This fault condition can occur when the output capacitor remains charged and the input is reduced to zero, or when an external voltage higher than the input voltage is applied to the output side.

◆ **ESD**

MM : 200pF 0Ω 200V or more

HBM : 100pF 1.5kΩ 2000V or more

13-3. Layout

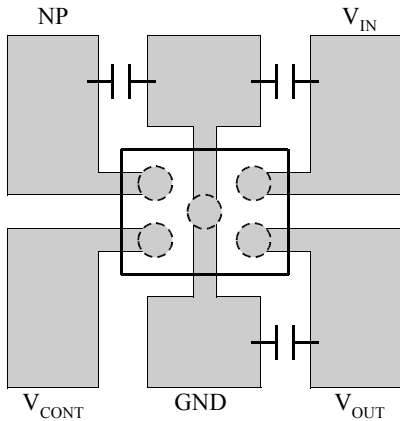

PCB Material : Glass epoxy (t=0.8mm)
Size=7mm×8mm

Please do derating with 4.8mW/°C at $P_D=450mW$ and 25°C or more. Thermal resistance (θ_{JA}) is=278°C/W.

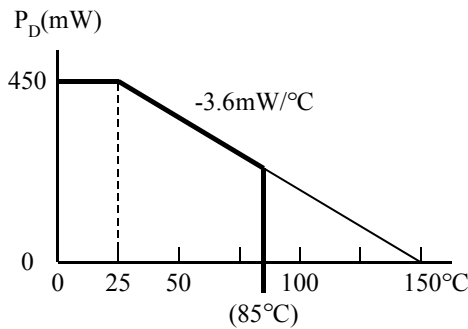

The package loss is limited at the temperature that the internal temperature sensor works (about 150°C). Therefore, the package loss is assumed to be an internal limitation. There is no heat radiation characteristic of the package unit assumed because of the small size. Heat is carried away by the device being mounted on the PCB. This value changes by the material and the copper pattern etc. of the PCB. The losses are approximately 450mW. Enduring these losses becomes possible in a lot of applications operating at 25°C.

The overheating protection circuit operates when there are a lot of losses with the regulator (When outside temperature is high or heat radiation is bad). The output current cannot be pulled enough and the output voltage will drop when the protection circuit operates. When the junction temperature reaches 150°C, the IC is shut down. However, operation begins at once when the IC stops operation and the temperature of the chip decreases.

How to determine the thermal resistance when mounted on PCB

The thermal resistance when mounted is expressed as follows:

$$T_J = \theta_{JA} \times P_D + T_A$$

T_J of IC is set around 150°C. P_D is the value when the thermal sensor is activated.

If the ambient temperature is 25°C, then:

$$150 = \theta_{JA} \times P_D + 25$$

$$\theta_{JA} = 125 / P_D \text{ (}^\circ\text{C/mW)}$$

P_D is easily calculated.

A simple way to determine P_D is to calculate $V_{IN} \times I_{IN}$ when the output side is shorted. Input current gradually falls as temperature rises. You should use the value when thermal equilibrium is reached. In many cases, heat radiation is good, and P_D has 500mW or more.

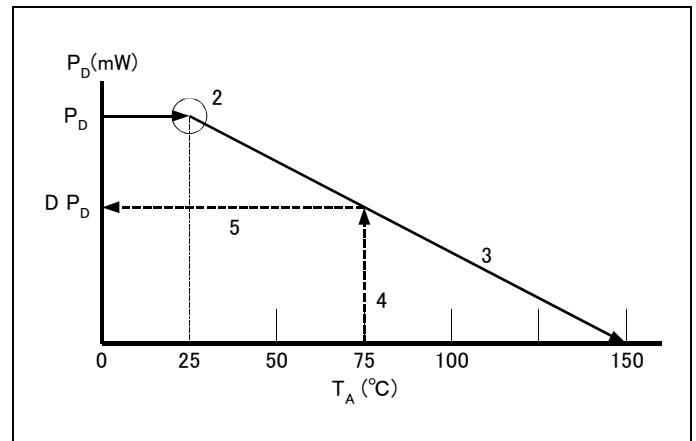

Procedure (When mounted on PCB.)

1. Find P_D ($V_{IN} \times I_{IN}$ when the output side is short-circuited).
2. Plot P_D against 25°C.
3. Connect P_D to the point corresponding to the 150°C with a straight line.
4. In design, take a vertical line from the maximum operating temperature (e.g., 75°C) to the derating curve.
5. Read off the value of P_D against the point at which the vertical line intersects the derating curve. This is taken as the maximum power dissipation DP_D .
6. $DP_D \div (V_{IN,MAX} - V_{OUT}) = I_{OUT}$ (at 75°C)

The maximum output current at the highest operating temperature will be $I_{OUT} \cong DP_D \div (V_{IN,MAX} - V_{OUT})$. Please use the device at low temperature with better radiation. The lower temperature provides better quality.

13-4. On/Off Control

It is recommended to turn the regulator OFF when the circuit following the regulator is non-operating. A design with little electric power loss can be implemented. We recommend the use of the ON/OFF control of the regulator without using a high side switch to provide an output from the regulator. A highly accurate output voltage with low voltage drop is obtained.

Because the control current is small, it is possible to control it directly by CMOS logic.

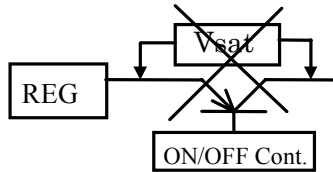

Control Terminal Voltage (V_{CONT})	ON/OFF State
$V_{CONT} > 1.8V$	ON
$V_{CONT} < 0.35V$	OFF

13-5. Noise Bypass

The noise and the ripple rejection characteristics depend on the capacitance on the NP terminal.

The ripple rejection characteristic of the low frequency region improves by increasing the capacitance of C_{NP} .

A standard value is $C_{NP}=0.001\mu F$. Increase C_{NP} in a design with important output noise and ripple rejection requirements. The IC will not be damaged if the capacitor value is increased.

The ON/OFF switching speed changes depending on the Np terminal capacitance. The switching speed slows when the capacitance is large.

13-6. Influence by Light

When this IC is exposed to strong light, the electrical characteristics change.

Please confirm the influence by light while mounted.

Parallel Connected ON/OFF Control

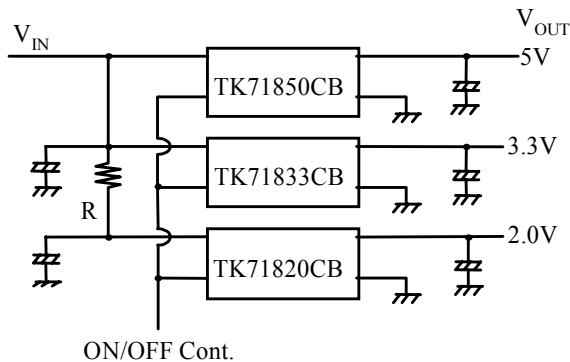

The above figure is multiple regulators being controlled by a single ON/OFF control signal. There is fear of overheating, because the power loss of the low voltage side IC (TK71820CB) is large. The series resistor (R) is put in the input line of the low output voltage regulator in order to prevent over-dissipation. The voltage dropped across the resistor reduces the large input-to-output voltage across the regulator, reducing the power dissipation in the device. When the thermal sensor works, a decrease of the output voltage, oscillation, etc. may be observed.

13-7. Outline ; PCB ; Stamps

5-Bump Flip Chip (FC-5)

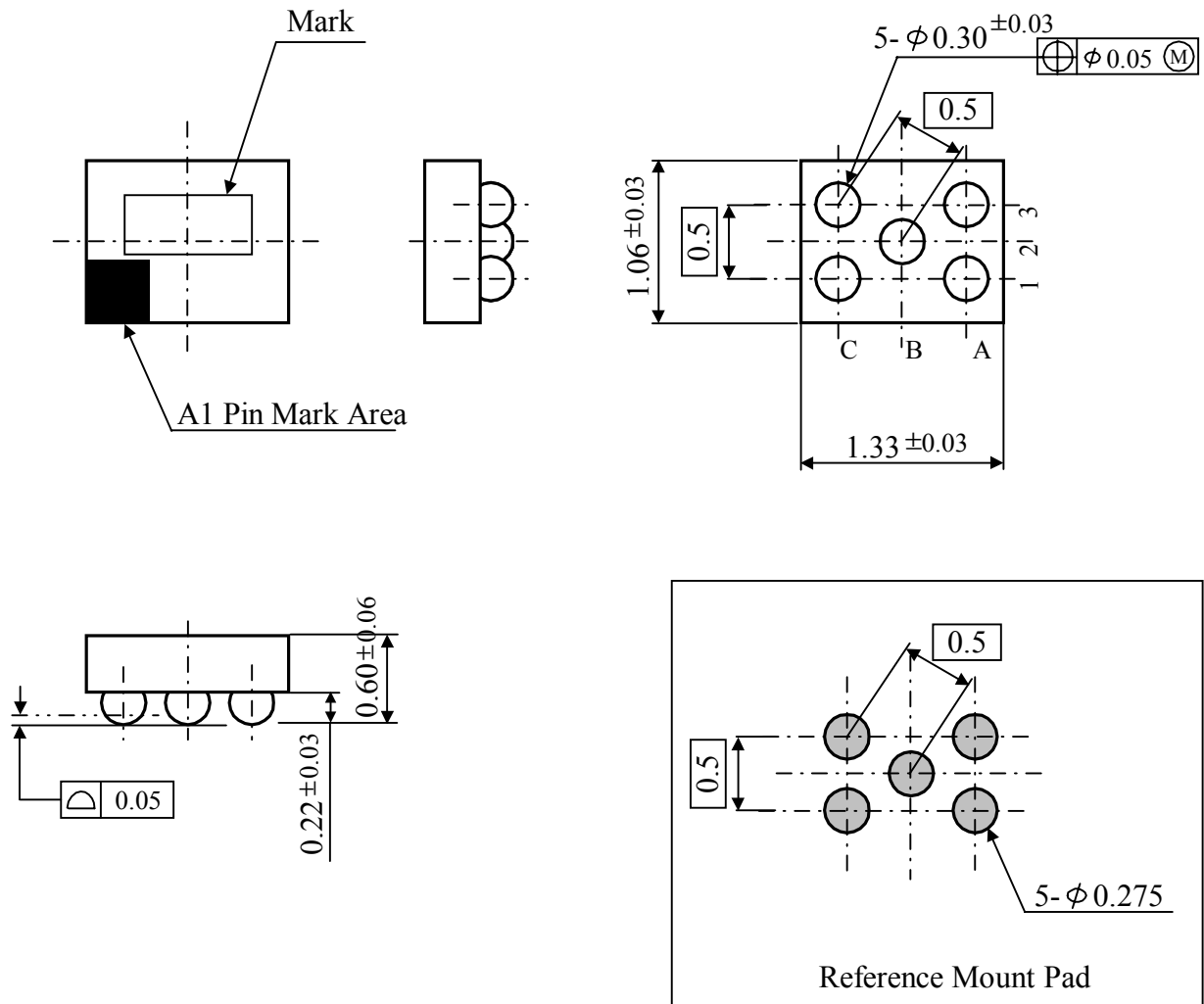

Unit : mm

Package Structure and Others

Base Material : Si
 Terminal Material : Solder Bump
 Solder Composition : Sn-40Pb

Mark Method : Laser
 Country of Origin : Japan
 Mass : 0.0018g

Stamps

Part Number	Mark	Part Number	Mark
TK71818CB	A18	TK71820CB	A20
TK71825CB	A25	TK71827CB	A27
TK71828CB	A28	TK71829CB	A29
TK71830CB	A30	TK71831CB	A31
TK71833CB	A33		

14. NOTES

■ Please be sure that you carefully discuss your planned purchase with our office if you intend to use the products in this application manual under conditions where particularly extreme standards of reliability are required, or if you intend to use products for applications other than those listed in this application manual.

- Power drive products for automobile, ship or aircraft transport systems; steering and navigation systems, emergency signal communications systems, and any system other than those mentioned above which include electronic sensors, measuring, or display devices, and which could cause major damage to life, limb or property if misused or failure to function.

- Medical devices for measuring blood pressure, pulse, etc., treatment units such as coronary pacemakers and heat treatment units, and devices such as artificial organs and artificial limb systems which augment physiological functions.

- Electrical instruments, equipment or systems used in disaster or crime prevention.

■ Semiconductors, by nature, may fail or malfunction in spite of our devotion to improve product quality and reliability. We urge you to take every possible precaution against physical injuries, fire or other damages which may cause failure of our semiconductor products by taking appropriate measures, including a reasonable safety margin, malfunction preventive practices and fire-proofing when designing your products.

■ This application manual is effective from Feb. 2003. Note that the contents are subject to change or discontinuation without notice. When placing orders, please confirm specifications and delivery condition in writing.

■ TOKO is not responsible for any problems nor for any infringement of third party patents or any other intellectual property rights that may arise from the use or method of use of the products listed in this application manual. Moreover, this application manual does not signify that TOKO agrees implicitly or explicitly to license any patent rights or other intellectual property rights which it holds.

■ None of the ozone depleting substances (ODS) under the Montreal Protocol are used in our manufacturing.

15. OFFICES

If you need more information on this product and other TOKO products, please contact us.

■ TOKO Inc. Headquarters
 1-17, Higashi-yukigaya 2-chome, Ohta-ku, Tokyo,
 145-8585, Japan
 TEL: +81.3.3727.1161
 FAX: +81.3.3727.1176 or +81.3.3727.1169
 Web site: <http://www.toko.co.jp/>

■ TOKO America
 Web site: <http://www.toko.com/>

■ TOKO Europe
 Web site: <http://www.tokoeurope.com/>

■ TOKO Hong Kong
 Web site: <http://www.toko.com.hk/>

■ TOKO Taiwan
 Web site: <http://www.toko.com.tw/>

■ TOKO Singapore
 Web site: <http://www.toko.com.sg/>

■ TOKO Seoul
 Web site: <http://www.toko.co.kr/>

■ TOKO Manila
 Web site: <http://www.toko.com.ph/>

■ TOKO Brazil
 Web site: <http://www.toko.com.br/>



TO BUILD THE QUALITY RELIED BY COSTOMERS
Semiconductor Division

YOUR DISTRIBUTOR