

Technical Data
Data Sheet 2963, Rev. -

87CNQ020 SCHOTTKY RECTIFIER

Applications:

- Parallel switching power supply • Redundant power subsystems • Reverse battery protection
- Converters

Features:

- 150°C T_J operation
- Center tap module
- Optimized for 3.3V applications
- High purity, high temperature epoxy encapsulation for enhanced mechanical strength and moisture resistance
- Ultra low forward voltage drop
- High frequency operation
- Guard ring for enhanced ruggedness and long term reliability
- New fully transfer-mould low profile, small footprint, high current package

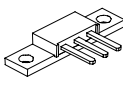
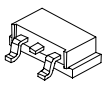
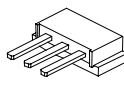
Case styles		
<p>87CNQ020</p>  <p>PRM2</p>	<p>87CNQ020SL</p>  <p>PRM2-SL</p>	<p>87CNQ020SM</p>  <p>PRM2-SM</p>

Mechanical Dimensions: In Inches / mm

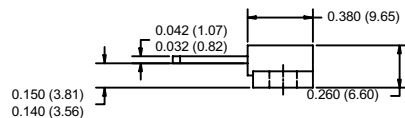
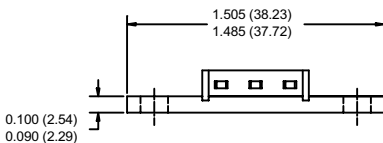
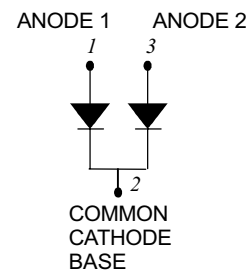
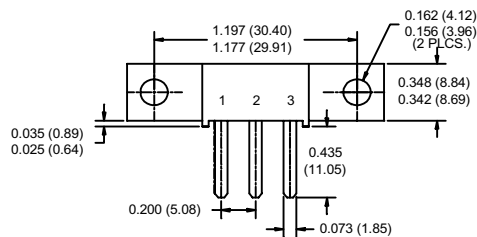

PRM2

Data Sheet 2963, Rev. -

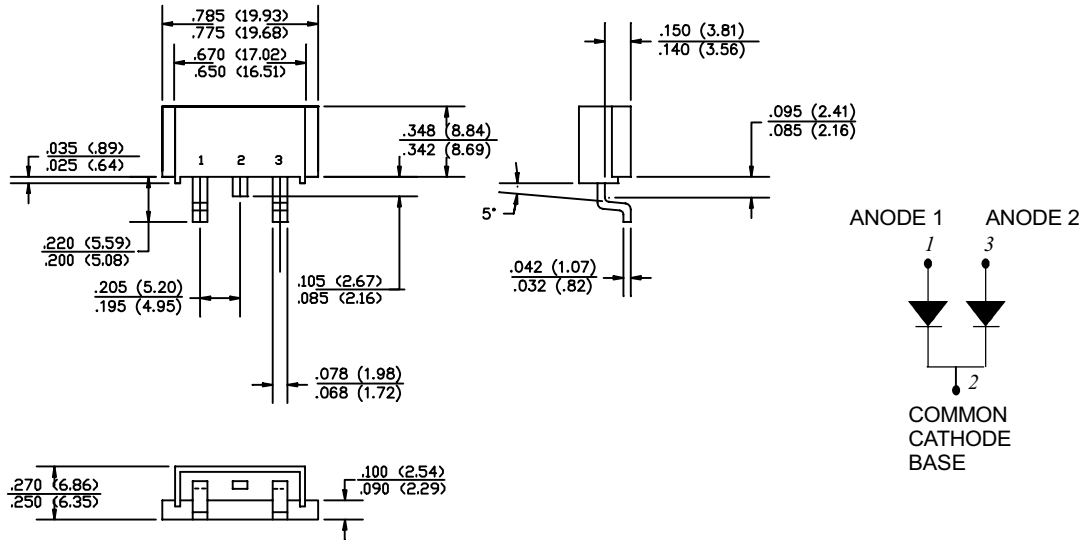

PRM2-SL

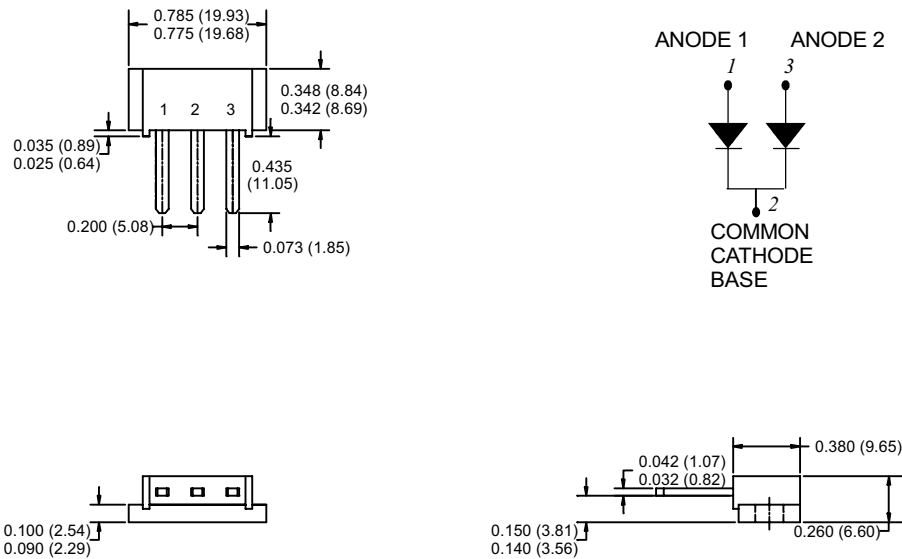

PRM2-SM

Data Sheet 2963, Rev. -
Maximum Ratings:

Characteristics	Symbol	Condition	Max.	Units
Peak Inverse Voltage	V_{RWM}	-	20 (DC, @125°C) 10 (DC, @150°C)	V
Max. Average Forward Current	$I_{F(AV)}$	50% duty cycle @ $T_C = 135^\circ\text{C}$, rectangular wave form	40 (per leg) 80 (per device)	A
Max. Peak One Cycle Non-Repetitive Surge Current (per leg)	I_{FSM}	8.3 ms, half Sine pulse	1320	A
Non-Repetitive Avalanche Energy (per leg)	E_{AS}	$T_J = 25^\circ\text{C}$, $I_{AS} = 8\text{A}$, $L = 1.12\text{ mH}$	36	mJ
Repetitive Avalanche Current (per leg)	I_{AR}	Current decaying linearly to zero in 1 μsec Frequency limited by T_J max. $V_A = 1.5 \times V_R$ typical	8	A

Electrical Characteristics:

Characteristics	Symbol	Condition	Max.	Units
Max. Forward Voltage Drop (per leg) *	V_{F1}	@ 40 A, Pulse, $T_J = 25^\circ\text{C}$ @ 80 A, Pulse, $T_J = 25^\circ\text{C}$	0.45 0.51	V
	V_{F2}	@ 40 A, Pulse, $T_J = 125^\circ\text{C}$ @ 80 A, Pulse, $T_J = 125^\circ\text{C}$	0.32 0.39	V
	V_{F3}	@ 40 A, Pulse, $T_J = 150^\circ\text{C}$ @ 80 A, Pulse, $T_J = 150^\circ\text{C}$	0.29 0.37	
Max. Reverse Current (per leg) *	I_{R1}	@ $V_R = \text{rated } V_R$ $T_J = 25^\circ\text{C}$	5.5	mA
	I_{R2}	@ $V_R = \text{rated } V_R$ $T_J = 125^\circ\text{C}$	550	mA
	I_{R3}	@ $V_R = 5\text{ V}$ $T_J = 125^\circ\text{C}$	90	mA
	I_{R4}	@ $V_R = 3.3\text{ V}$ $T_J = 125^\circ\text{C}$	70	mA
	I_{R5}	@ $V_R = 10\text{ V}$ $T_J = 150^\circ\text{C}$	480	mA
Max. Junction Capacitance (per leg)	C_T	@ $V_R = 5\text{ V}$, $T_C = 25^\circ\text{C}$ $f_{SIG} = 1\text{MHz}$	6500	pF
Typical Series Inductance (per leg)	L_S	Measured lead to lead 5 mm from package body	5.5	nH
Max. Voltage Rate of Change	dv/dt	-	10,000	V/ μs

* Pulse Width < 300 μs , Duty Cycle <2%

Thermal-Mechanical Specifications:

Characteristics	Symbol	Condition	Specification	Units
Max. Junction Temperature	T_J	-	-55 to +150	°C
Max. Storage Temperature	T_{stg}	-	-55 to +150	°C
Maximum Thermal Resistance Junction to Case (per leg)	$R_{\theta JC}$	DC operation	0.85	°C/W
Maximum Thermal Resistance Junction to Case (per package)	$R_{\theta JC}$	DC operation	0.42	°C/W
Maximum Thermal Resistance, Case to Heat Sink (D61-8 Only)	$R_{\theta CS}$	Mounting surface, smooth and greased Device flatness < 5 mils	0.30	°C/W
Approximate Weight	wt	-	7.8	
Mounting Torque (D61-8 Only)	T_M	-	40 (min) 58 (max)	Kg-cm
Case Style	PRM2 PRM2-SL PRM2-SM			

Data Sheet 2963, Rev. -

Typical Forward Characteristics

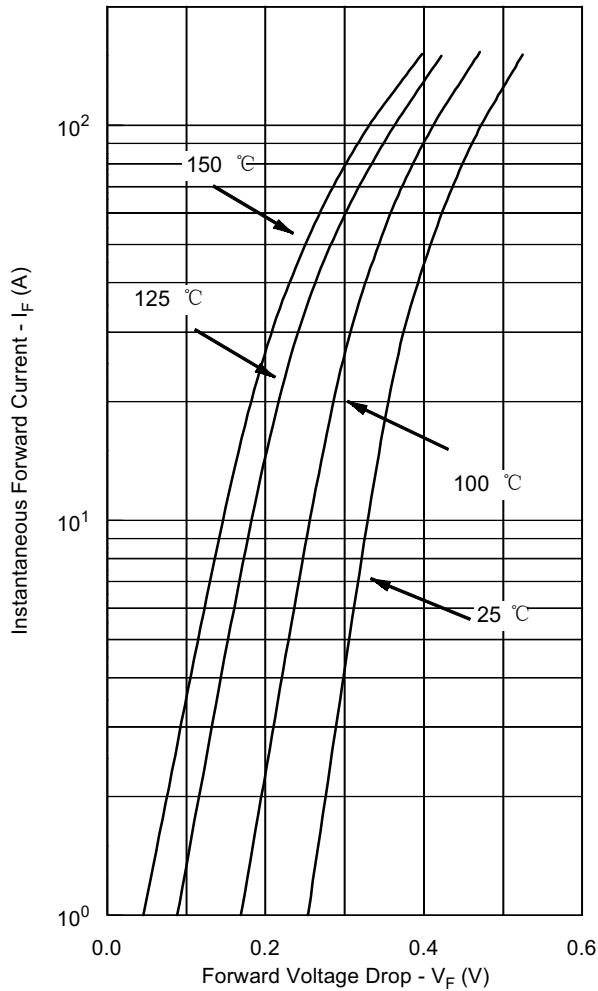

Typical Reverse Characteristics

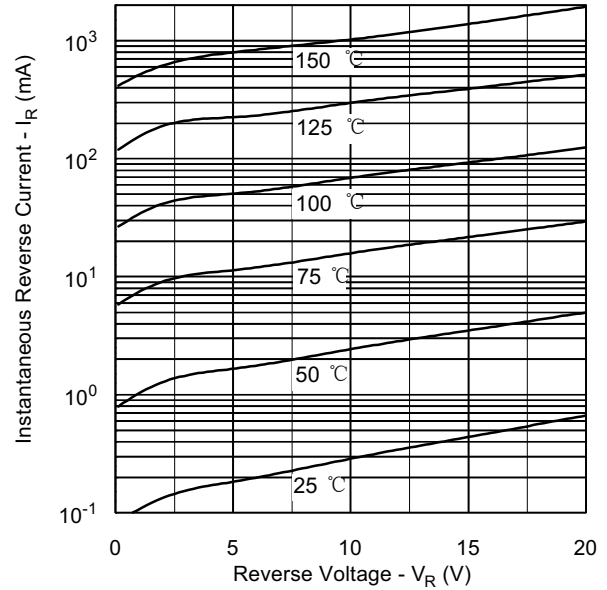

Typical Junction Capacitance

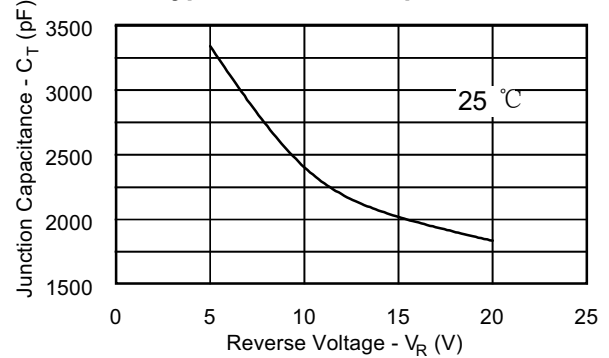

TECHNICAL DATA

DISCLAIMER:

- 1- The information given herein, including the specifications and dimensions, is subject to change without prior notice to improve product characteristics. Before ordering, purchasers are advised to contact the Sensitron Semiconductor sales department for the latest version of the datasheet(s).
- 2- In cases where extremely high reliability is required (such as use in nuclear power control, aerospace and aviation, traffic equipment, medical equipment, and safety equipment), safety should be ensured by using semiconductor devices that feature assured safety or by means of users' fail-safe precautions or other arrangement.
- 3- In no event shall Sensitron Semiconductor be liable for any damages that may result from an accident or any other cause during operation of the user's units according to the datasheet(s). Sensitron Semiconductor assumes no responsibility for any intellectual property claims or any other problems that may result from applications of information, products or circuits described in the datasheets.
- 4- In no event shall Sensitron Semiconductor be liable for any failure in a semiconductor device or any secondary damage resulting from use at a value exceeding the absolute maximum rating.
- 5- No license is granted by the datasheet(s) under any patents or other rights of any third party or Sensitron Semiconductor.
- 6- The datasheet(s) may not be reproduced or duplicated, in any form, in whole or part, without the expressed written permission of Sensitron Semiconductor.
- 7- The products (technologies) described in the datasheet(s) are not to be provided to any party whose purpose in their application will hinder maintenance of international peace and safety nor are they to be applied to that purpose by their direct purchasers or any third party. When exporting these products (technologies), the necessary procedures are to be taken in accordance with related laws and regulations.