VFM STEP-UP DC/DC CONVERTER

NO.EA-045-0602

OUTLINE

The RN5RKxx1A/xx1B/xx2A Series are CMOS-based VFM (Chopper) Step-up DC/DC converter ICs with ultra low supply current and high output voltage accuracy.

Each of the RN5RKxx1A/xx1B consists of an oscillator, a VFM control circuit, a driver transistor to have low ON resistance (Lx switch), a reference voltage unit, a high speed comparator, resistors for voltage detection, an Lx switch protection circuit and an internal chip enable circuit. A low ripple, high efficiency step-up DC/DC converter can be composed of this RN5RKxx1A/xx1B with only three external components: an inductor, a diode and a capacitor.

The RN5RKxx2A uses the same chip as what is employed in the RN5RKxx1A/1B IC and has a drive pin (EXT) for an external transistor instead of an Lx pin. As it is possible to load a large output current with a power transistor which has a low saturation voltage, RN5RKxx2A IC is recommendable to users who need an output current as large as between several tens mA and several hundreds mA.

Using the chip enable function, it is possible to make the supply current on standby minimized.

Since the package for these ICs is SOT-23-5 (Mini-mold), high density mounting of the ICs on board is possible.

FEATURES

- Small Number of External Components Only an inductor, a diode and a capacitor (RN5RKxx1A/xx1B)
- Standby Current Typ. 0 μ A
- High Output Voltage Accuracy $\pm 2.5\%$
- Low Ripple and Low Noise
- Low Start-up Voltage Max. 0.9V
- High Efficiency Typ. 80%
- Including a Driver Transistor with Low ON Resistance Only RN5RKxx1A/xx1B
- Two Kinds of Duty Ratio 77% (xx1A, xx2A)/ 55% (xx1B)
- Output Voltage Range 2.0V to 5.5V
- Low Temperature-Drift Coefficient of Output Voltage Typ. ± 100 ppm/ $^{\circ}$ C
- Small Packages SOT-23-5 (Mini-Mold)

APPLICATIONS

- Power source for battery-powered equipment.
- Power source for cameras, camcorders, VCRs, and hand-held communication equipment.
- Power source for those appliances which require higher cell voltage than that of batteries.

OUTLINE DIAGRAM

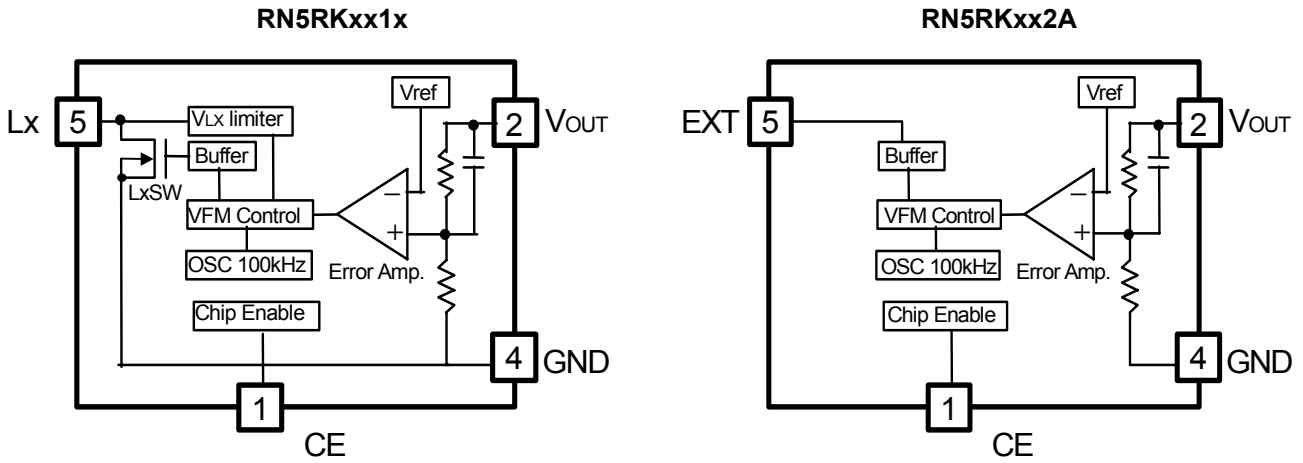

SELECTION GUIDE

The output voltage, the driver type, the duty cycle and the taping type for the ICs can be selected at the user's request.

The selection can be made by designating the part number as shown below:

RN5RKxxxx-xx ← Part Number
 ↑↑↑ ↑
 a bc d

Code	Contents
a	Setting Output Voltage (V _{OUT}) : Stepwise setting with a step of 0.1V in the range of 2.0V to 5.5V is possible.
b	Designation of Driver 1: Internal Lx Tr. Driver 2: External Tr. Driver
c	Designation of Duty Cycle A: 77% B: 55%
d	Designation of Taping type Ex. TR, TL (refer to Taping Specifications, TR type is prescribed as a standard.)

PIN CONFIGURATIONS

• SOT-23-5

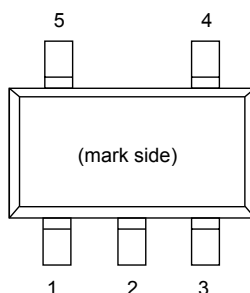

PIN DISCRIPTION

• RN5RKxx1x

Pin No.	Symbol	Description
1	CE	Chip Enable Pin
2	V _{OUT}	Step-up Output Monitoring Pin, Power Supply (for device itself)
3	NC	No Connection
4	GND	Ground Pin
5	Lx	Switching Pin (Nch Open Drain)

• RN5RKxx2x

Pin No.	Symbol	Description
1	CE	Chip Enable Pin
2	V _{OUT}	Step-up Output Monitoring Pin, Power Supply (for device itself)
3	NC	No Connection
4	GND	Ground Pin
5	EXT	External Tr. Drive Pin (CMOS Output)

ABSOLUTE MAXIMUM RATINGS

Symbol	Item	Rating	Unit
V _{OUT}	Step-up Output Pin Voltage	9.0	V
V _{LX}	LX Pin Voltage	9.0	V
V _{EXT}	EXT Pin Voltage	-0.3 to V _{OUT} +0.3	V
V _{CE}	CE Pin Voltage	-0.3 to V _{OUT} +0.3	V
I _{LX}	Lx Pin Output Current	500	mA
I _{EXT}	EXT Pin Output Current	±30	mA
P _D	Power Dissipation (SOT-23-5)* ¹	420	mW
Topt	Operating Temperature Range	-40 to +85	°C
Tstg	Storage Temperature Range	-55 to +125	°C

*1)For Power Dissipation, please refer to PACKAGE INFORMATION to be described.

ABSOLUTE MAXIMUM RATINGS

Absolute Maximum ratings are threshold limit values that must not be exceeded even for an instant under any conditions. Moreover, such values for any two items must not be reached simultaneously. Operation above these absolute maximum ratings may cause degradation or permanent damage to the device. These are stress ratings only and do not necessarily imply functional operation below these limits.

ELECTRICAL CHARACTERISTICS

• RN5RKxx1A/xx1B

T_{opt}=25°C

Symbol	Item	Conditions	Min.	Typ.	Max.	Unit
V _{OUT}	Output Voltage	V _{IN} =Set V _{OUT} ×0.6, I _{OUT} =1mA	×0.975		×1.025	V
V _{IN}	Input Voltage				8.0	V
ΔV _{OUT} / ΔT _{opt}	Output Voltage Temperature Coefficient	-40°C ≤ T _{opt} ≤ 85°C		±100		ppm /°C
V _{start}	Start-Up Voltage	V _{IN} =0V→2V* ¹		0.75	0.90	V
ΔV _{start} / ΔT _{opt}	Start-Up Voltage Temperature Coefficient	-40°C ≤ T _{opt} ≤ 85°C V _{IN} =0V→2V* ¹		-1.6		mV/ °C
V _{hold}	Hold-on Voltage (xx1A)	V _{IN} =2V→0V* ¹	0.7			V
V _{hold}	Hold-on Voltage (xx1B)	V _{IN} =2V→0V* ¹	0.9			V
I _{DD2}	Supply Current ₂	V _{OUT} =V _{CE} =Set V _{OUT} +0.5V		2	5	μA
I _{standby}	Supply Current (Standby)	V _{OUT} =6V, V _{CE} =0V			0.5	μA
I _{LXleak}	Lx Leakage Current	V _{OUT} =V _{LX} =8V			1	μA
f _{osc}	Maximum Oscillator Frequency	V _{OUT} =V _{CE} =Set V _{OUT} ×0.96	80	100	120	kHz
Δf _{osc} / ΔT _{opt}	Frequency Temperature Coefficient	-40°C ≤ T _{opt} ≤ 85°C		0.41		kHz/ °C
Duty	Oscillator Duty Cycle (xx1A)	V _{OUT} =V _{CE} =Set V _{OUT} ×0.96, ON (V _{LX} "L" side)	70	77	85	%
	Oscillator Duty Cycle (xx1B)		47	55	63	%
V _{lxl}	V _{LX} Voltage Limit	V _{OUT} =V _{CE} =1.95, Lx Switch ON	0.4	0.6	0.8	V
V _{CEH}	CE "H" Input Voltage	V _{OUT} =V _{CE} =Set V _{OUT} ×0.96, Judgment is made by the Lx waveform	0.9			V
V _{CEL}	CE "L" Input Voltage				0.3	V
I _{CEH}	CE "H" Input Current	V _{OUT} =6.0V, V _{CE} =6.0V	-0.5	0.0	0.5	μA
I _{CEL}	CE "L" Input Current	V _{OUT} =6.0V, V _{CE} =0.0V	-0.5	0.0	0.5	μA
I _{DD1}	Supply Current ₁ * ²	2.0V ≤ V _{OUT} ≤ 2.4V		25	50	μA
		2.5V ≤ V _{OUT} ≤ 2.9V		30	55	
		3.0V ≤ V _{OUT} ≤ 3.4V		35	60	
		3.5V ≤ V _{OUT} ≤ 3.9V		40	65	
		4.0V ≤ V _{OUT} ≤ 4.4V		45	75	
		4.5V ≤ V _{OUT} ≤ 4.9V		50	80	
		5.0V ≤ V _{OUT} ≤ 5.5V		60	90	

Symbol	Item	Conditions	Min.	Typ.	Max.	Unit
I _{LX}	Lx Switching Current	$2.0V \leq V_{OUT} \leq 2.4V, V_{LX}=0.4V$	80			mA
		$2.5V \leq V_{OUT} \leq 2.9V, V_{LX}=0.4V$	100			
		$3.0V \leq V_{OUT} \leq 3.4V, V_{LX}=0.4V$	120			
		$3.5V \leq V_{OUT} \leq 3.9V, V_{LX}=0.4V$	140			
		$4.0V \leq V_{OUT} \leq 4.4V, V_{LX}=0.4V$	160			
		$4.5V \leq V_{OUT} \leq 4.9V, V_{LX}=0.4V$	180			
		$5.0V \leq V_{OUT} \leq 5.5V, V_{LX}=0.4V$	200			

*1)Condition: An Output load resistor R_L is connected between V_{OUT} and GND.

Note that the resistor R_L has a resistance which makes an output current 1mA after step-up operation.

*2)The Supply Current 1 (I_{DD1}) for IC itself is measured when the internal oscillator works continuously.

If the oscillator works intermittently, the supply current becomes smaller than the value which is written on the above table.

Measurement condition: $V_{OUT}=V_{CE}=\text{Setting Output Voltage} \times 0.96$

RN5RK

• RN5RKxx2A

T_{opt}=25°C

Symbol	Item	Conditions	Min.	Typ.	Max.	Unit
V _{OUT}	Output Voltage	V _{IN} =Set V _{OUT} ×0.6, I _{OUT} =1mA	×0.975		×1.025	V
V _{IN}	Input Voltage				8.0	V
ΔV _{OUT} / ΔT _{opt}	Output Voltage Temperature Coefficient	-40°C ≤ T _{opt} ≤ 85°C		±100		ppm/ °C
V _{start}	Start-Up Voltage	V _{IN} =0V→2V* ¹		0.7	0.8	V
ΔV _{start} / ΔT _{opt}	Start-Up Voltage Temperature Coefficient	-40°C ≤ T _{opt} ≤ 85°C V _{IN} =0V→2V* ¹	-1.6			mV/ °C
I _{DD2}	Supply Current ₂	V _{OUT} =V _{CE} =Set V _{OUT} +0.5V		2	5	μA
I _{standby}	Supply Current (Standby)	V _{OUT} =6V, V _{CE} =0V			0.5	μA
f _{osc}	Maximum Oscillator Frequency	V _{OUT} =V _{CE} =Set V _{OUT} ×0.96	80	100	120	kHz
Δf _{osc} / ΔT _{opt}	Frequency Temperature Coefficient	-40°C ≤ T _{opt} ≤ 85°C		0.41		kHz/ °C
Duty	Oscillator Duty Cycle	V _{OUT} =V _{CE} =Set V _{OUT} ×0.96, ON (V _{LX} "H" side)	70	77	85	%
V _{CEH}	CE "H" Input Voltage	V _{OUT} =V _{CE} =Set V _{OUT} ×0.96, Judgment is made by the EXT waveform			0.3	V
V _{CEL}	CE "L" Input Voltage			0.7	0.8	V
I _{CEH}	CE "H" Input Current	V _{OUT} =6.0V, V _{CE} =6.0V	-0.5	0.0	0.5	μA
I _{CEL}	CE "L" Input Current	V _{OUT} =6.0V, V _{CE} =0.0V	-0.5	0.0	0.5	μA
I _{DD1}	Supply Current ₁ * ²	2.0V ≤ V _{OUT} ≤ 2.9V, EXT no load		20	40	μA
		3.0V ≤ V _{OUT} ≤ 3.9V, EXT no load		25	50	
		3.0V ≤ V _{OUT} ≤ 3.4V, EXT no load		30	60	
		3.5V ≤ V _{OUT} ≤ 3.9V, EXT no load		35	70	
I _{EXTH}	EXT "H" Output Current	2.0V ≤ V _{OUT} ≤ 2.4V, V _{EXT} =0.4V			-1.0	mA
		2.5V ≤ V _{OUT} ≤ 2.9V, V _{EXT} =0.4V			-1.5	
		4.0V ≤ V _{OUT} ≤ 5.5V, V _{EXT} =0.4V			-2.0	
	EXT "L" Output Current	2.0V ≤ V _{OUT} ≤ 2.9V, V _{EXT} =0.4V	1.0			
		3.0V ≤ V _{OUT} ≤ 3.9V, V _{EXT} =0.4V	1.5			
		4.0V ≤ V _{OUT} ≤ 5.5V, V _{EXT} =0.4V	2.0			

*1)Condition: An Output load resistor R_L is connected between V_{OUT} and GND.

Note that the resistor R_L has a resistance which makes an output current 1mA after step-up operation.

*2)The Supply Current 1 (I_{DD1}) for IC itself is measured when the internal oscillator works continuously.

If the oscillator works intermittently, the supply current becomes smaller than the value which is written on the above table. Measurement condition: V_{OUT}=V_{CE}=Setting Output Voltage×0.96

TEST CIRCUITS

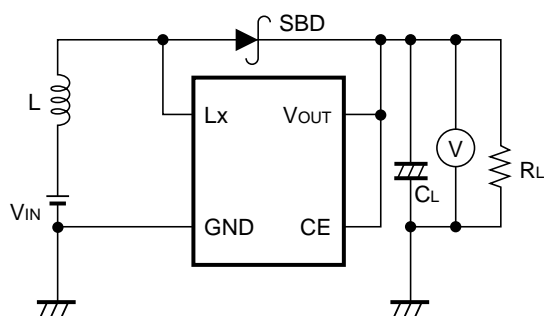

Test Circuit 1

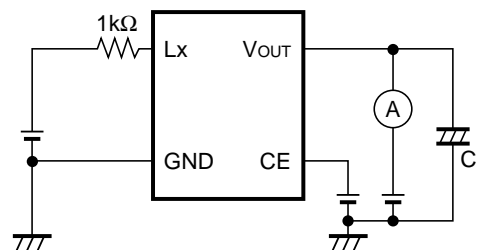

Test Circuit 2

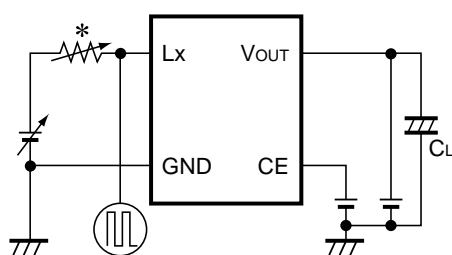

Oscilloscope

Test Circuit 3

*)When V_{Lxlim} and I_{Lx} are measured, the 5Ω resistor is used. Otherwise $1k\Omega$ is used.

Components Inductor (L) : 100 μ H, 220 μ H (Sumida Electric Co., Ltd; CD-54)
 Diode (SBD) : MA721 (Matsushita Electronics Corporation; Schottky Type)
 Capacitor (CL) : 47 μ F (Tantalum Type)

Using these test circuits characteristics data has been obtained as shown on the following pages.

Test Circuit 1: Typical Characteristics (1)-(7)

Test Circuit 2: Typical Characteristics (9)-(11)

Test Circuit 3: Typical Characteristics (8), (12)-(16)

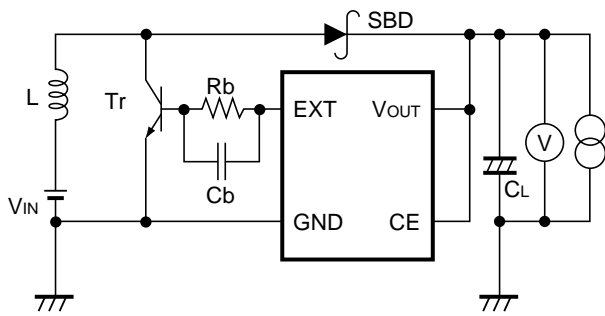

Test Circuit 1

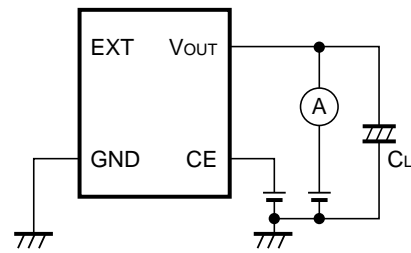

Test Circuit 2

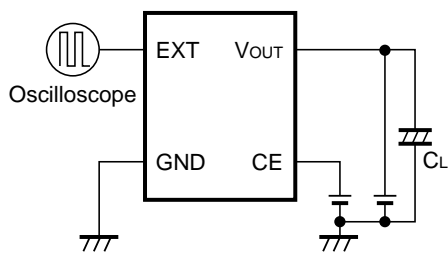

Test Circuit 3

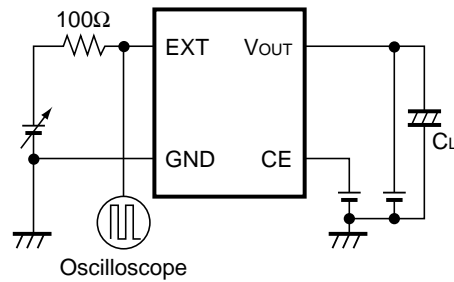

Test Circuit 4

Components Inductor	(L)	: 27 μ H (Sumida Electric Co., Ltd; CD-104)
Diode	(SBD)	: RB111C (Rohm Co., Ltd; Schottky Type)
Capacitor	(CL)	: 47 μ F \times 2(Tantalum Type)
Transistor	(Tr)	: 2SD1628G
Base Resistor	(Rb)	: 300 Ω Base Capacitor (Cb): 0.01 μ F

The typical characteristics were obtained with using these test circuits.

Test Circuit 1: Typical Characteristics (1)-(5)

Test Circuit 2: Typical Characteristics (8)-(10)

Test Circuit 3: Typical Characteristics (11)-(14)

Test Circuit 4: Typical Characteristics (6), (7)

TYPICAL CHARACTERISTICS

● RN5RKxx1A/B

1) Output Voltage vs. Output Current (Topt=25°C)

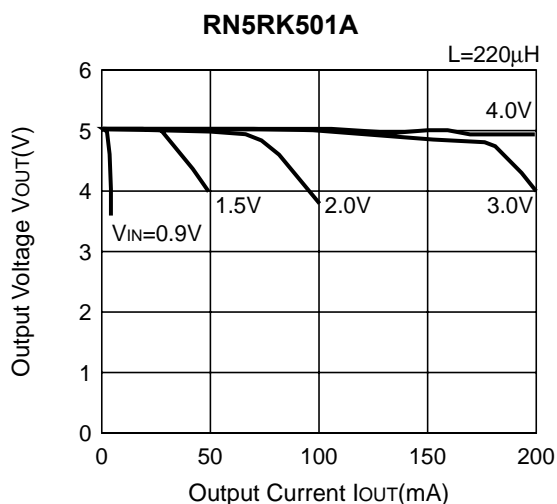
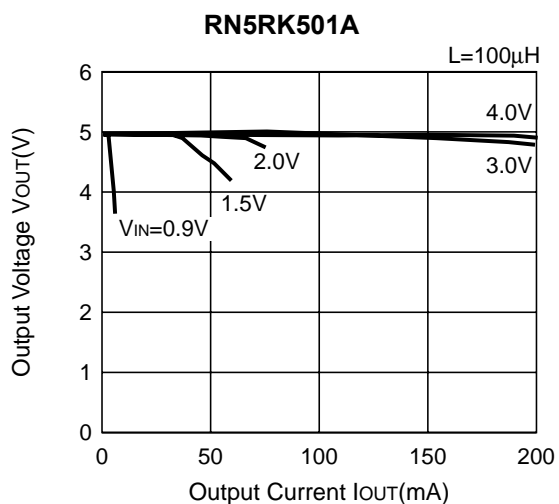
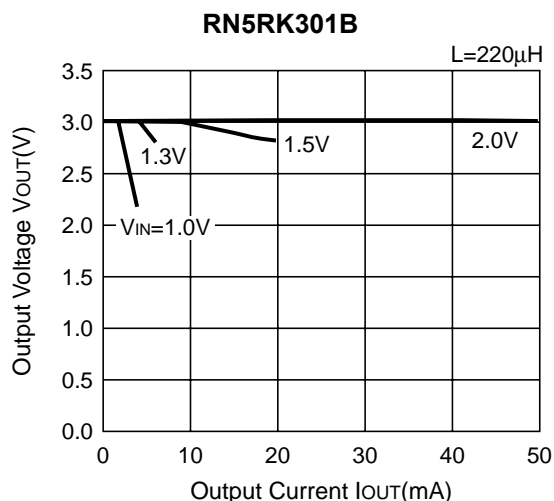
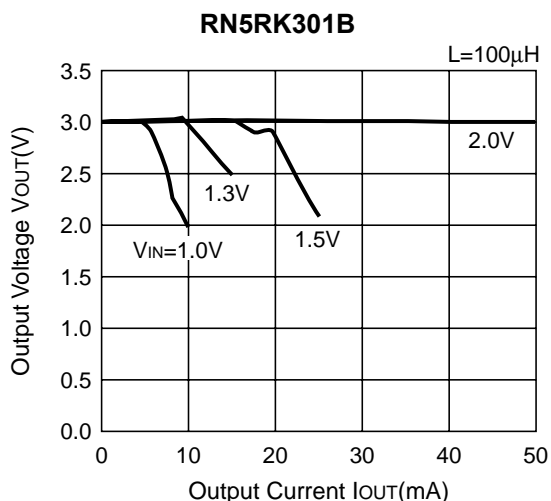
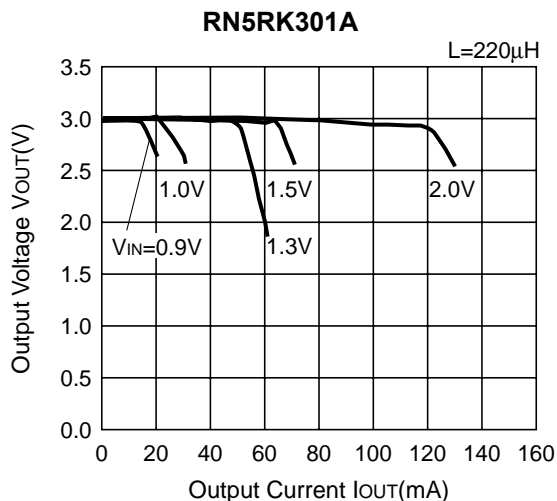
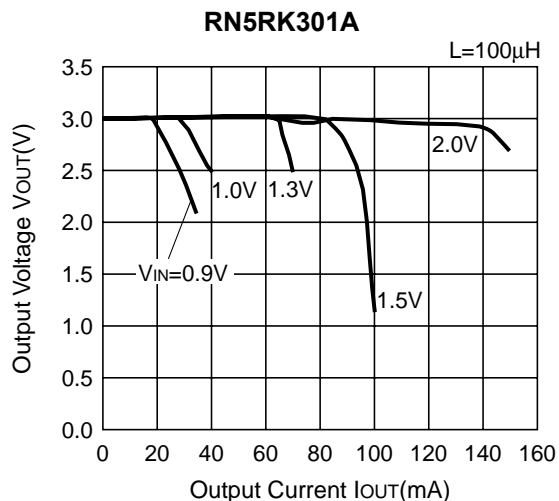

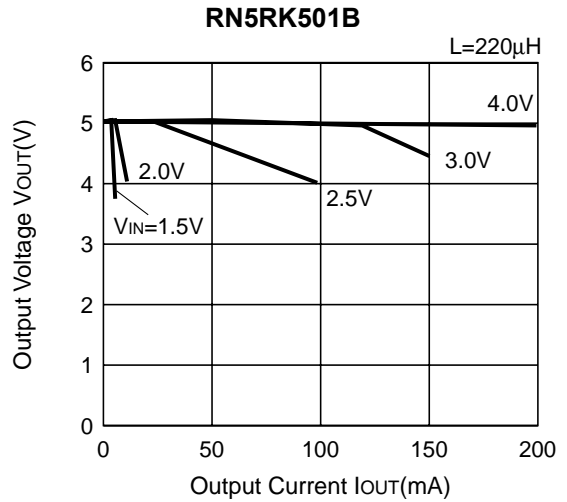
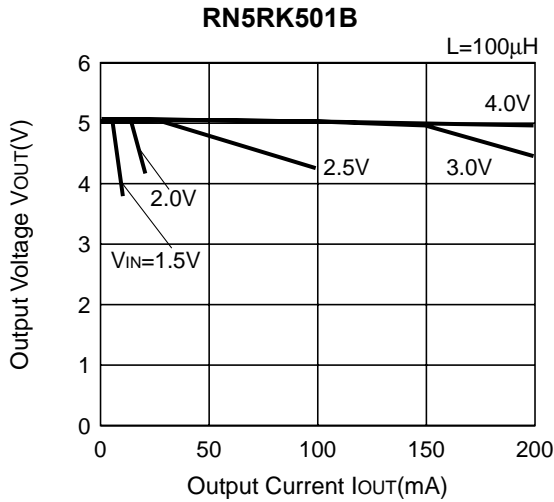

2) Efficiency vs. Output Current ($T_{opt}=25^{\circ}C$)

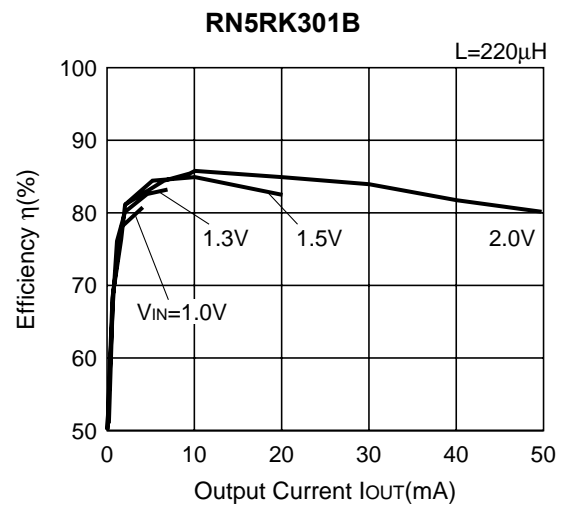
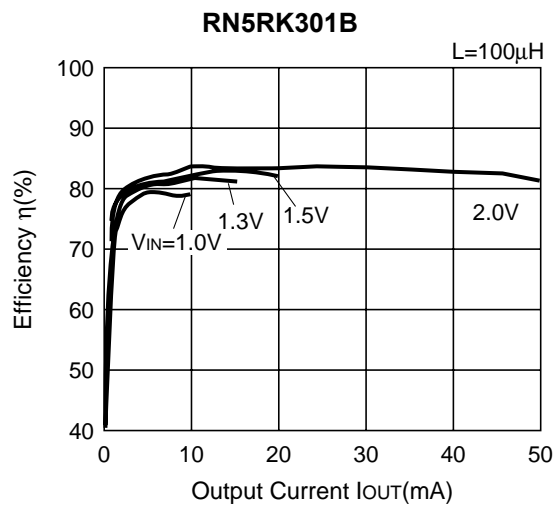
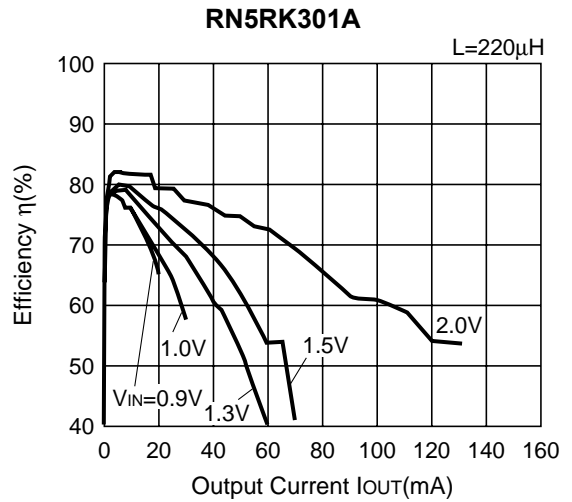
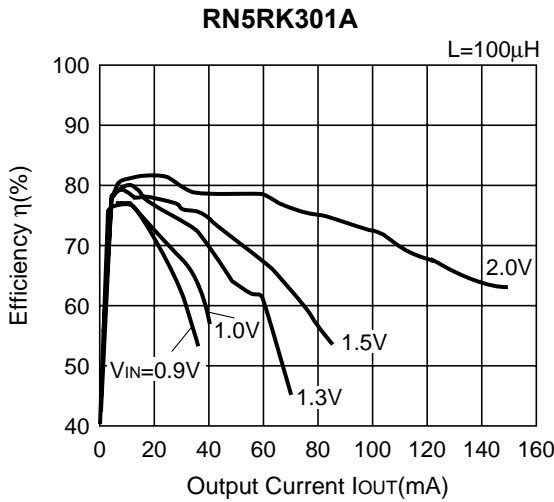

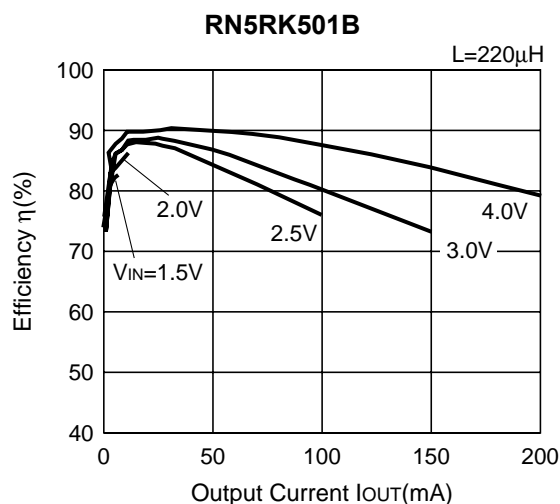
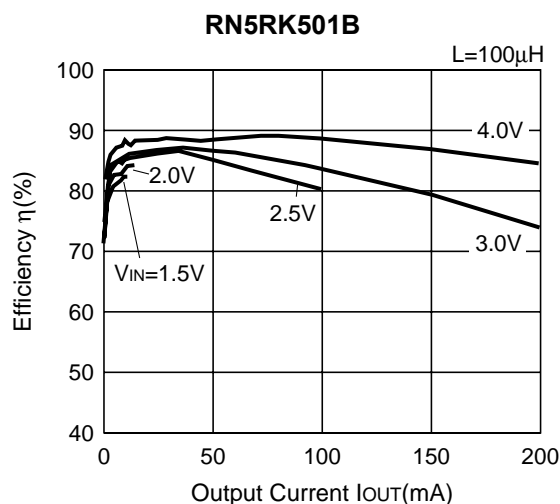
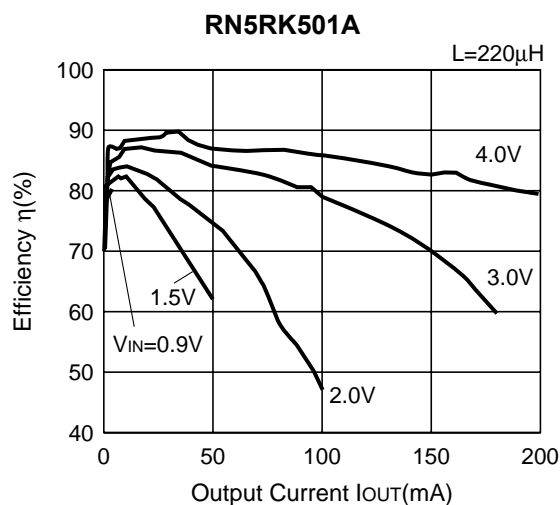
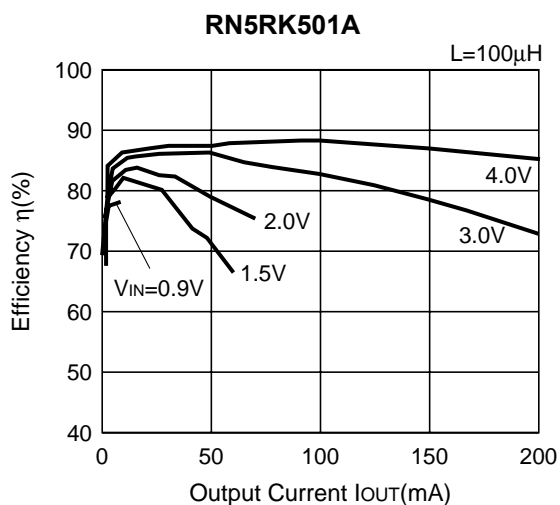

3) Ripple Voltage vs. Output Current (Topt=25°C)

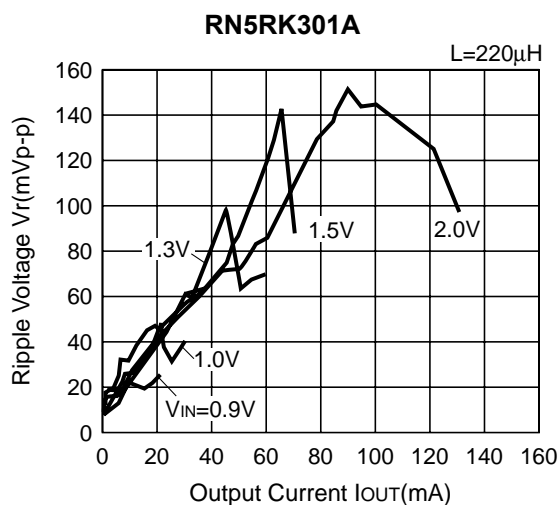
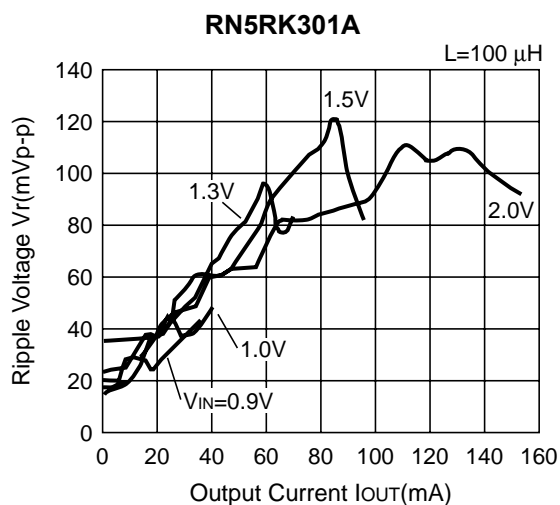

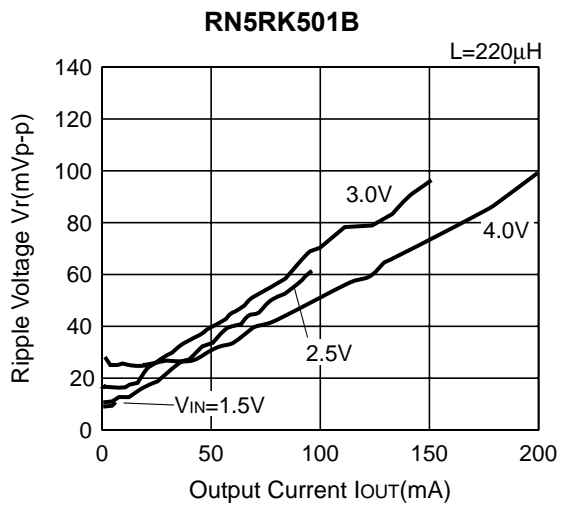
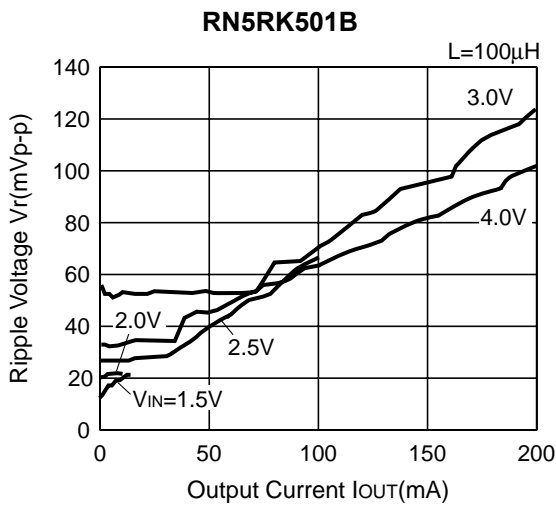
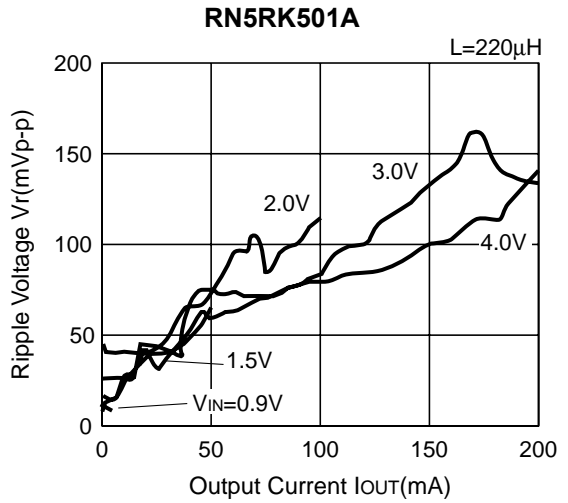
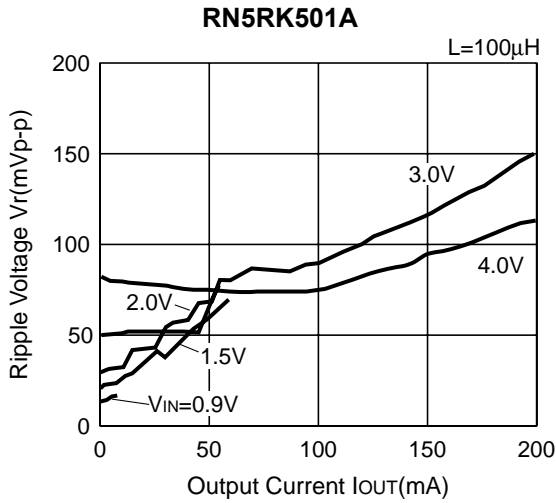
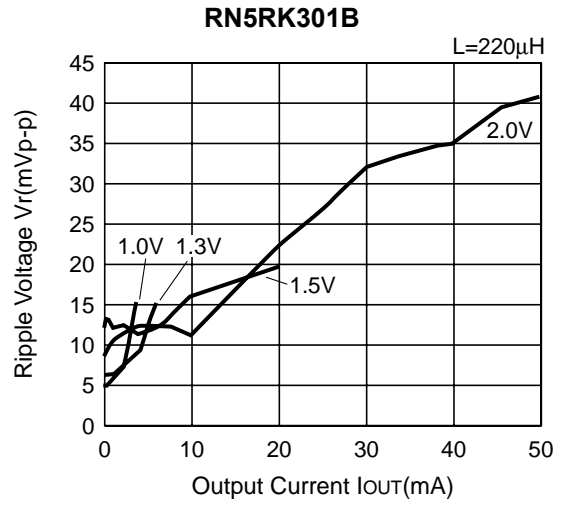
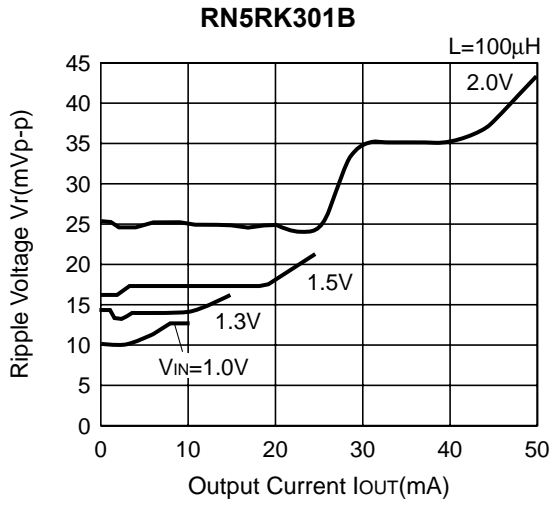

4) Start-up/Hold-on Voltage vs. Output Current (Topt=25 °C)

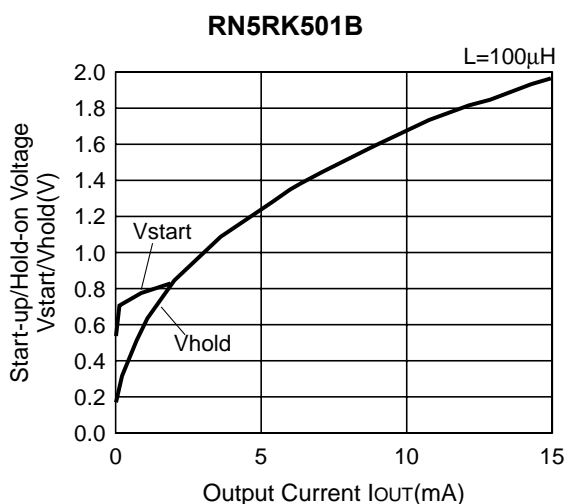
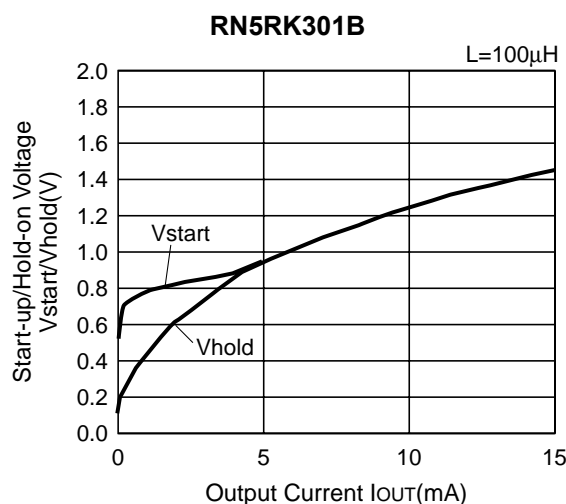
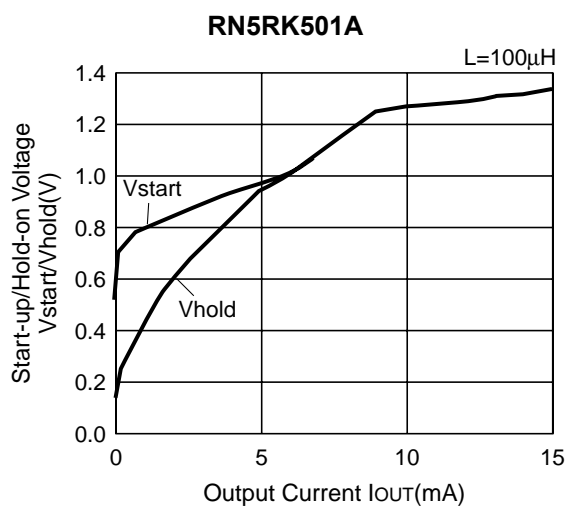
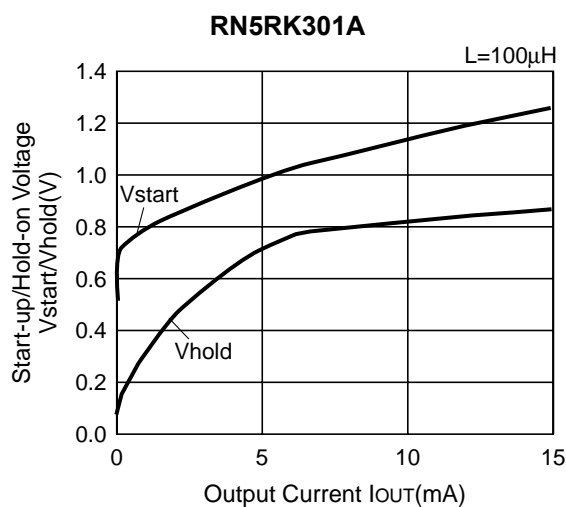

5) Output Voltage vs. Temperature

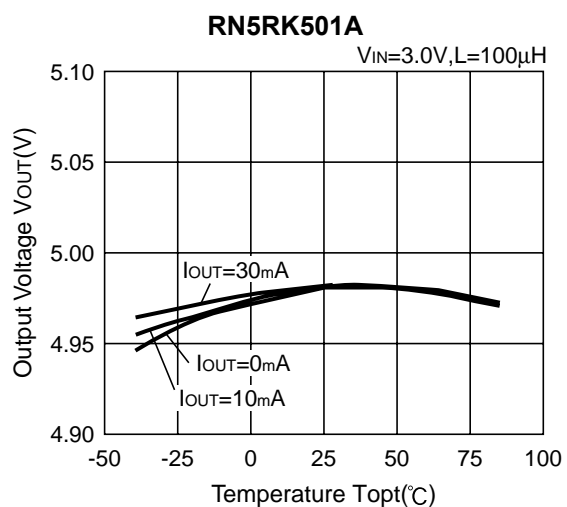
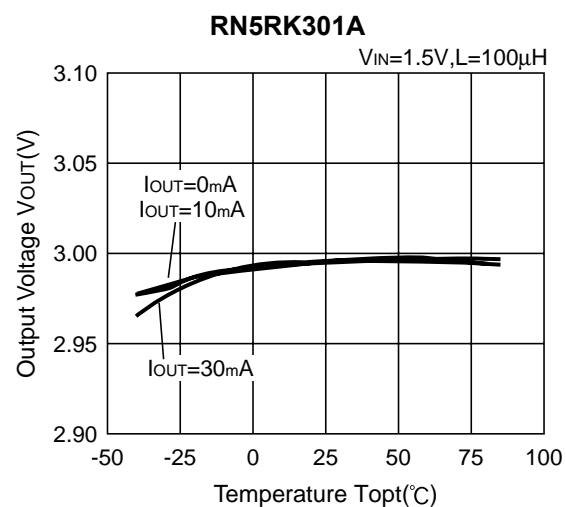

6) Start-up Voltage vs. Temperature

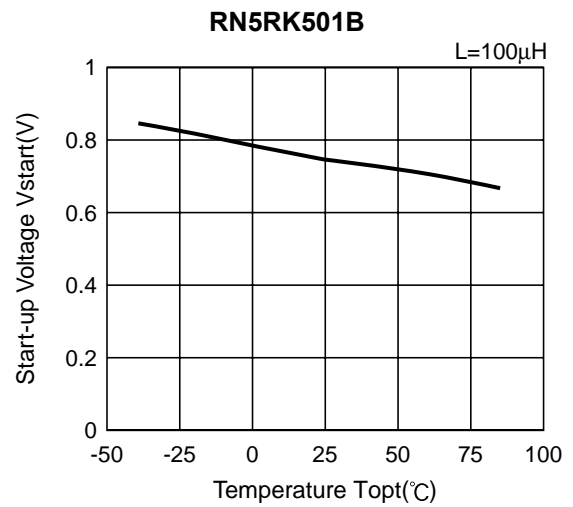
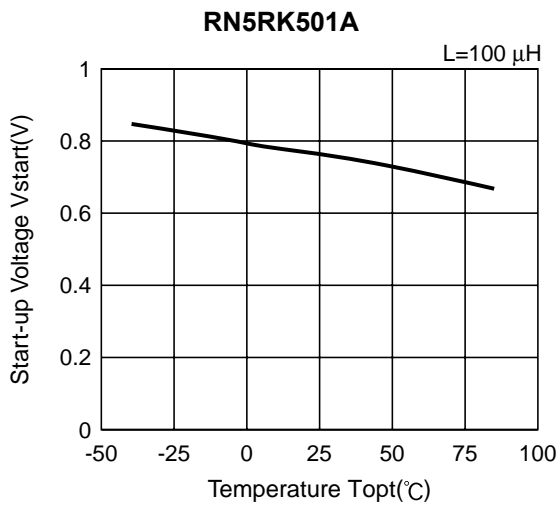

7) Hold-on Voltage vs. Temperature

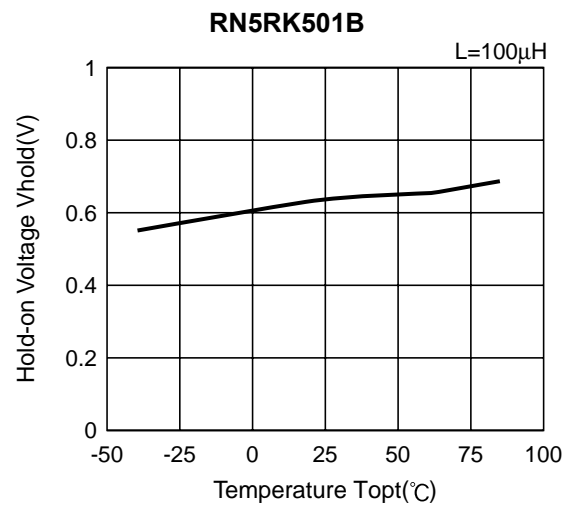
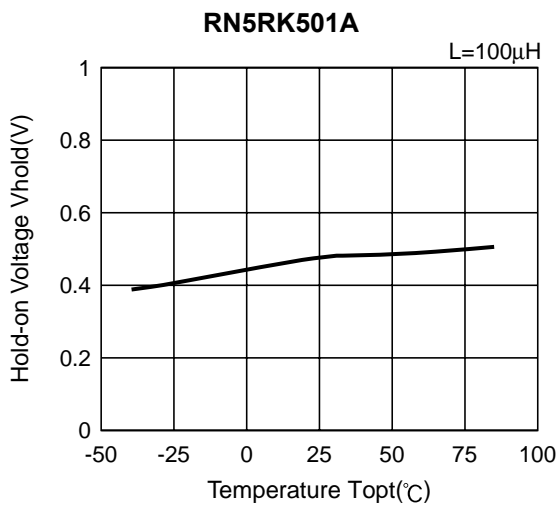

8) Lx Switching Current vs. Temperature

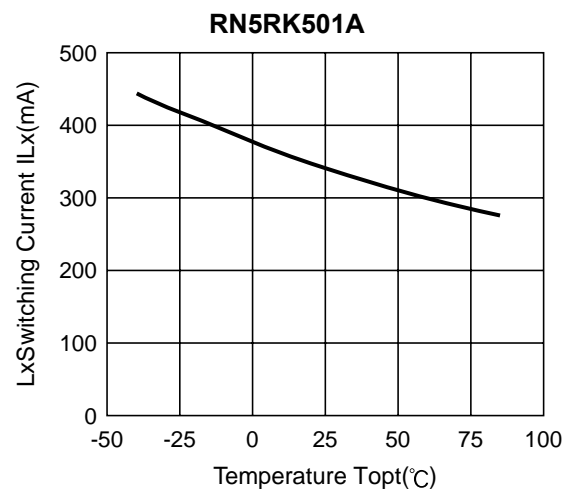
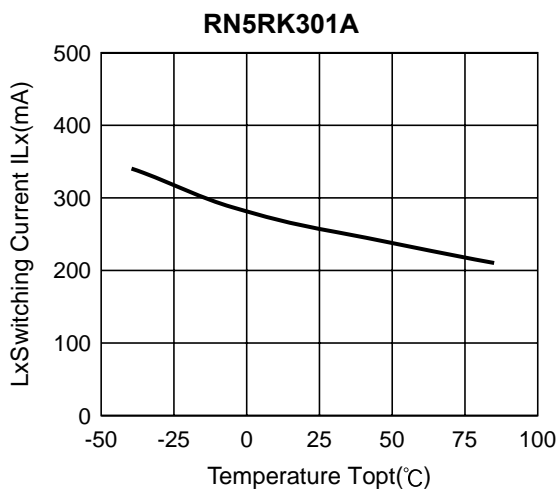

9) Supply Current 1 vs. Temperature

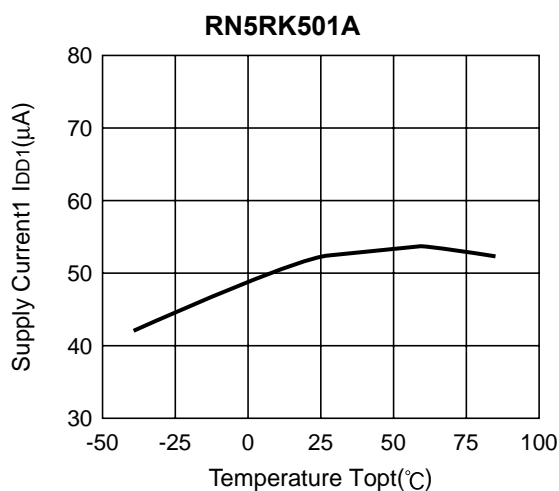
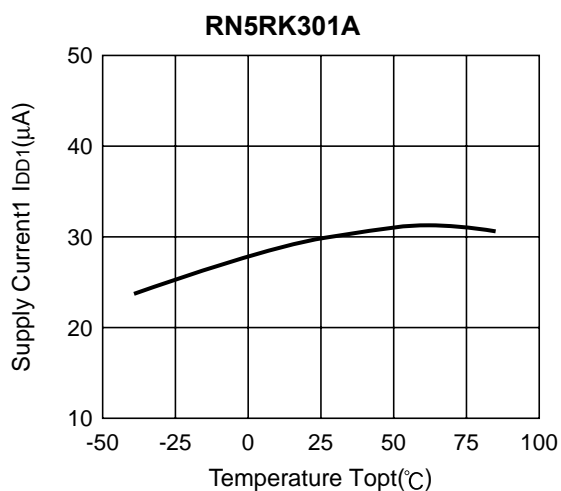

10) Supply Current 2 vs. Temperature

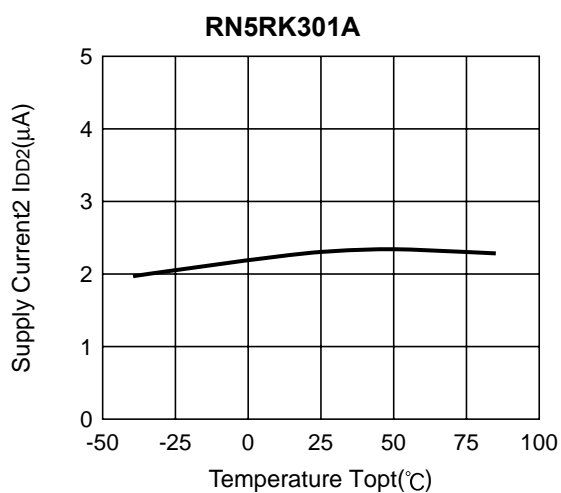

11) Standby Current 3 vs. Temperature

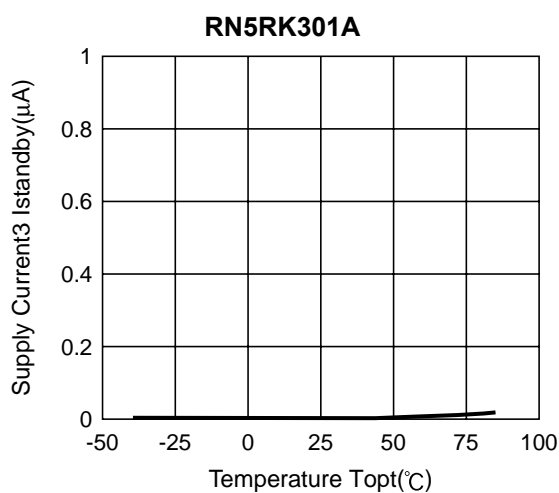

12) Oscillator Duty Cycle vs. Temperature

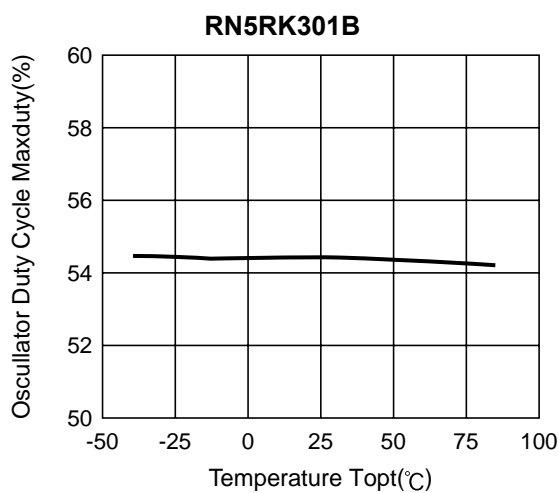
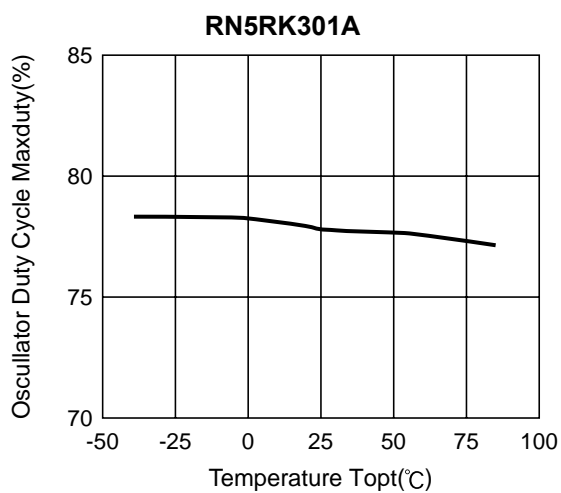

13) CE "H" Input Voltage vs. Temperature

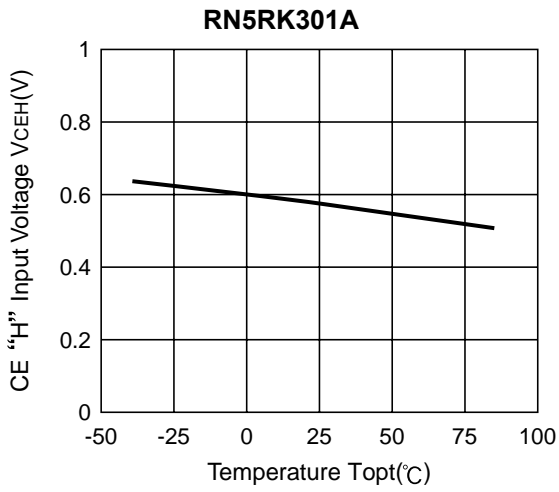

14) CE "L" Input Voltage vs. Temperature

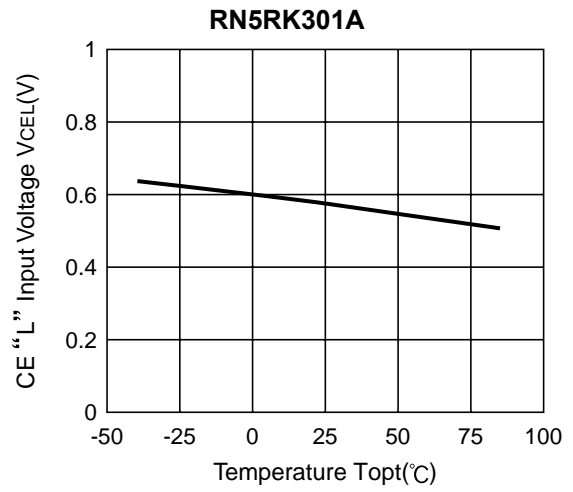

15) Maximum Oscillator Frequency vs. Temperature

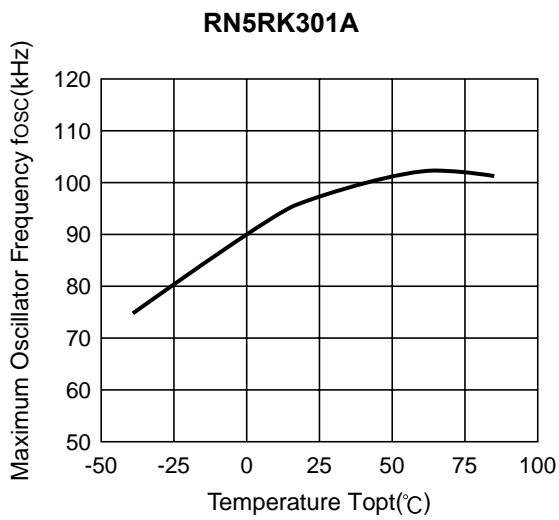

16) V_{Lx} Voltage Limit vs. Temperature

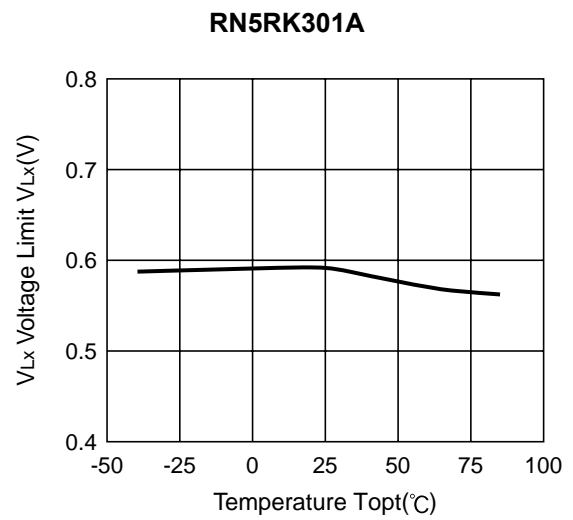

● RN5RKxx2A

1) Output Voltage vs. Output Current (Topt=25°C)

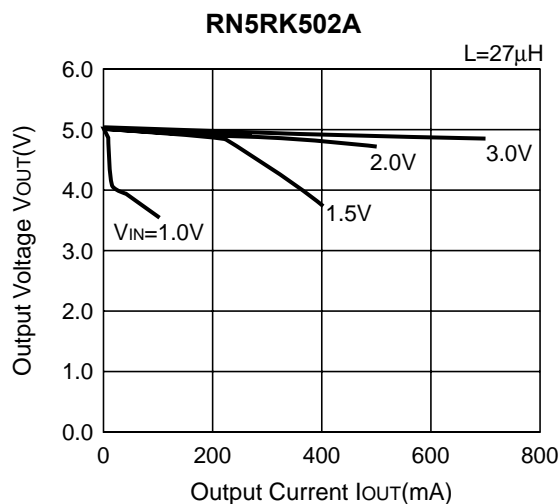
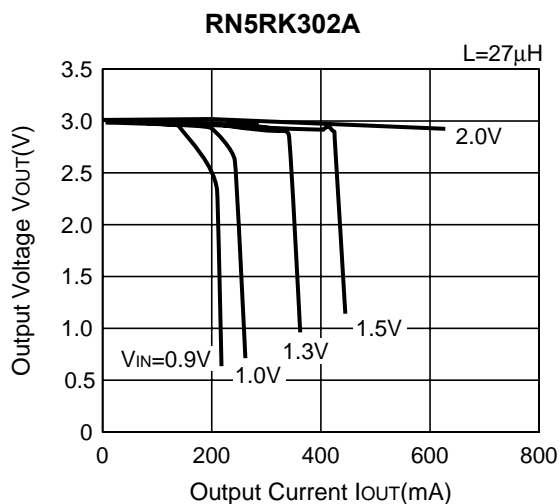

2) Efficiency vs. Output Current (Topt=25°C)

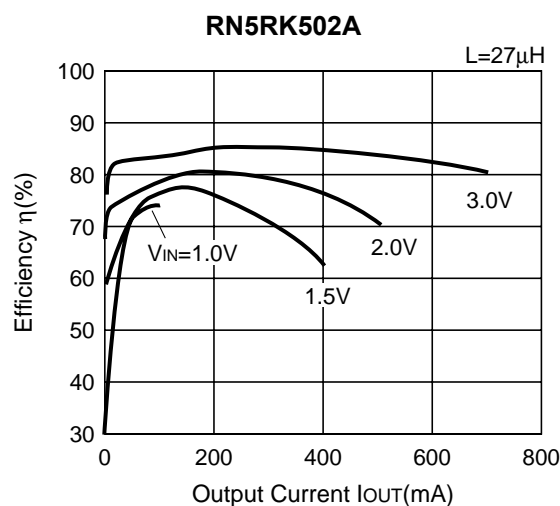
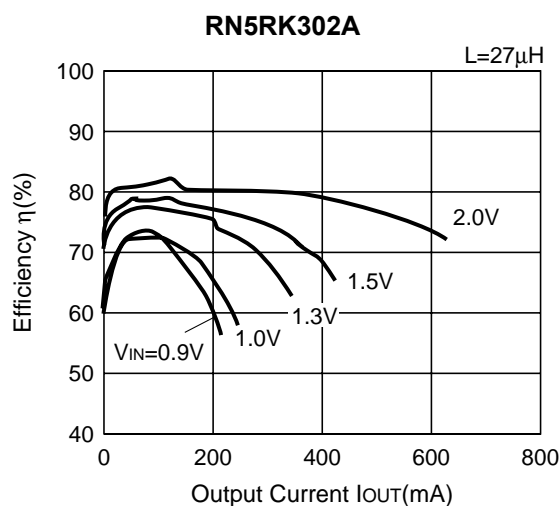

3) Ripple Voltage vs. Output Current (Topt=25°C)

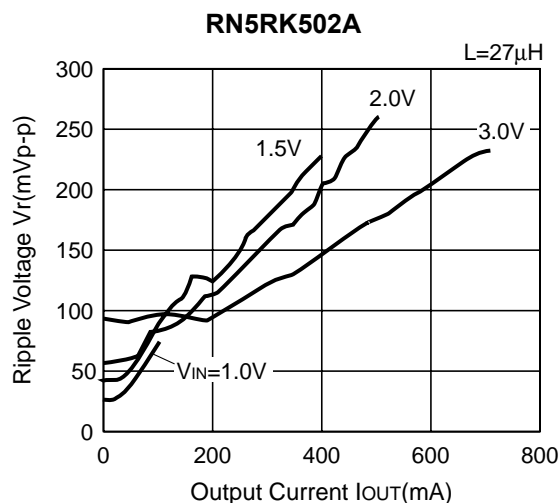
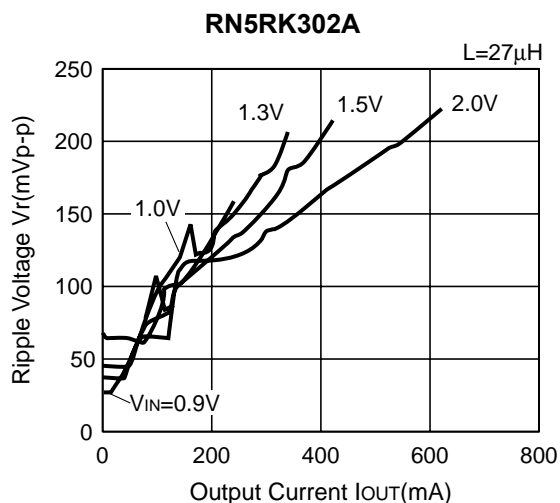

4) Start-up/Hold-on Voltage vs. Output Current (Topt=25°C)

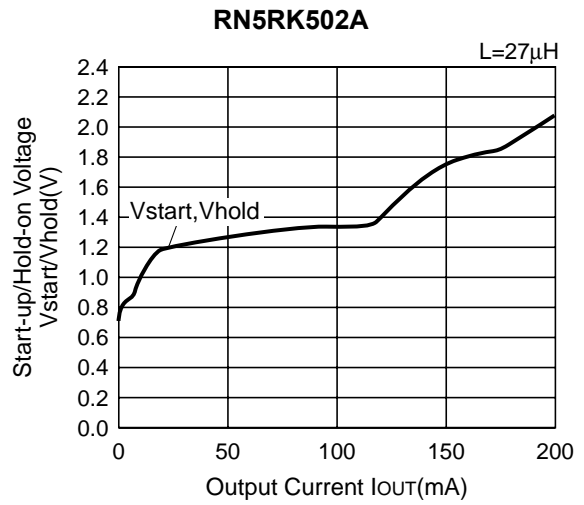
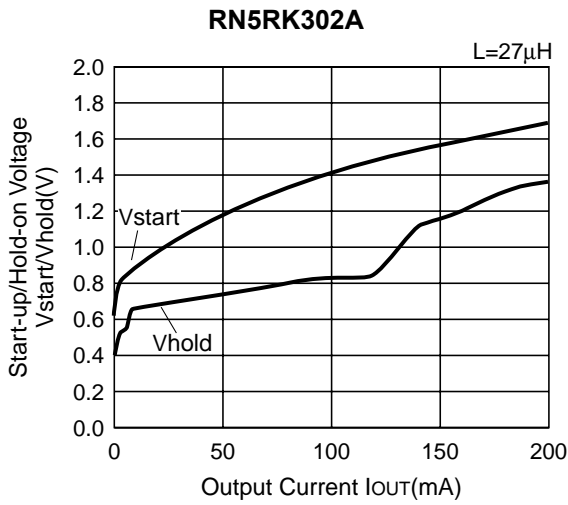

5) Output Voltage vs. Temperature

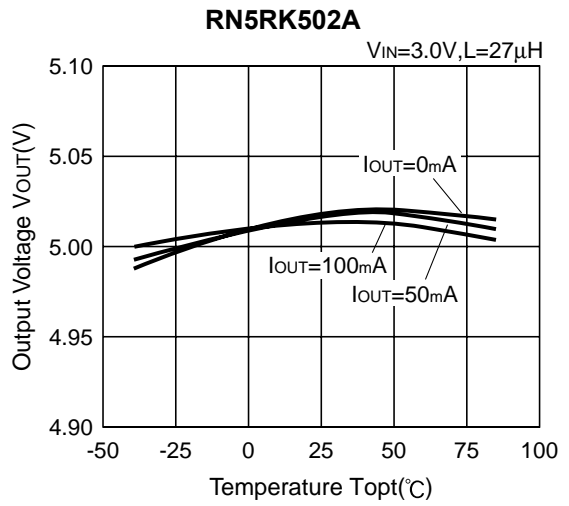
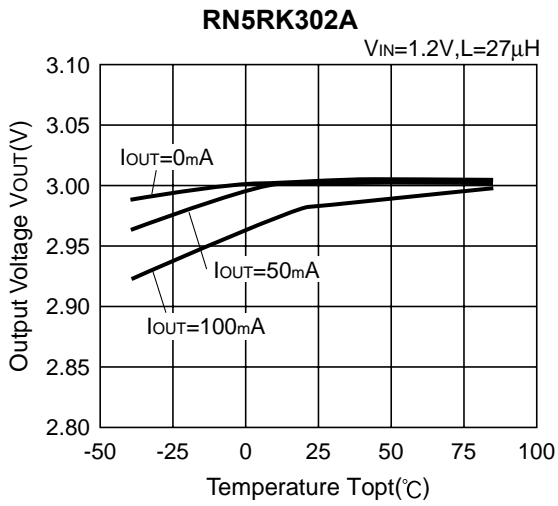

6) EXT "H" Output Current vs. Temperature

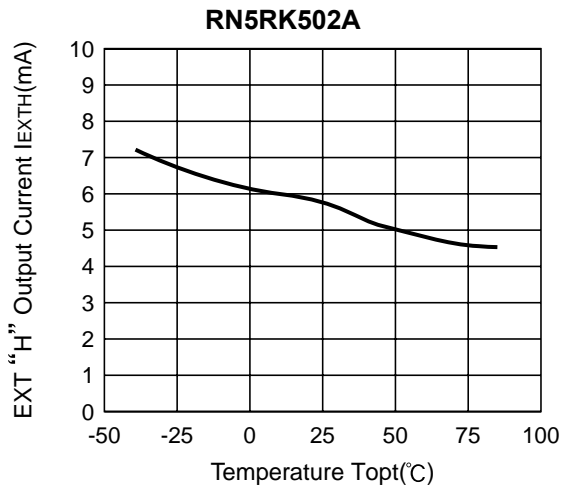
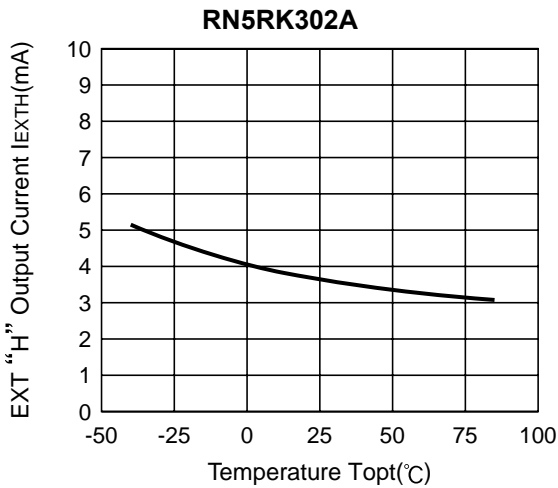

7) EXT "L" Output Current vs. Temperature

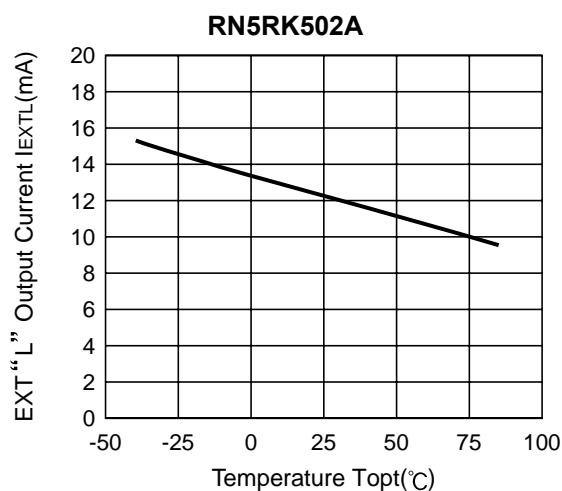
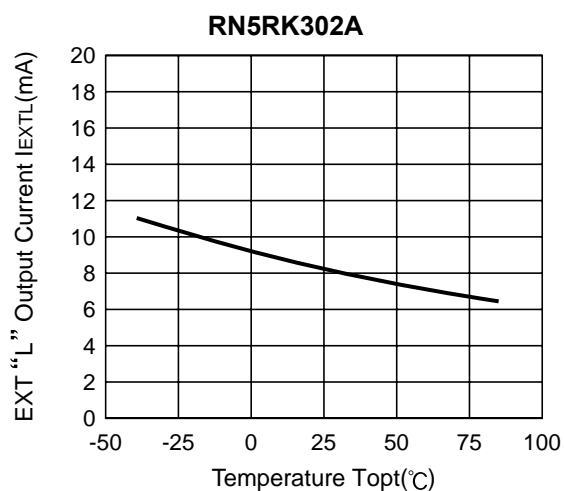

8) Supply Current 1 vs. Temperature

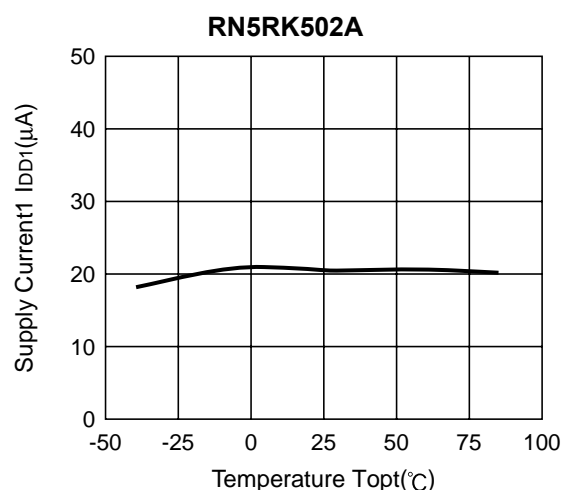
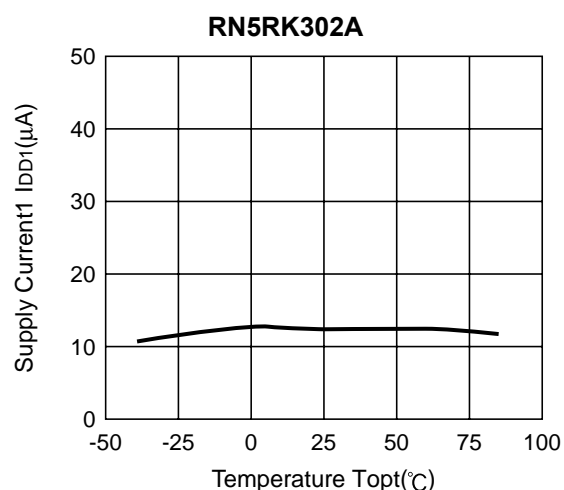

9) Supply Current 2 vs. Temperature

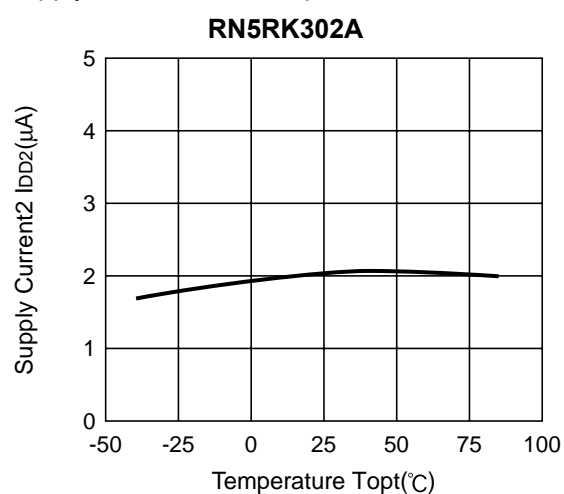

10) Standby Current vs. Temperature

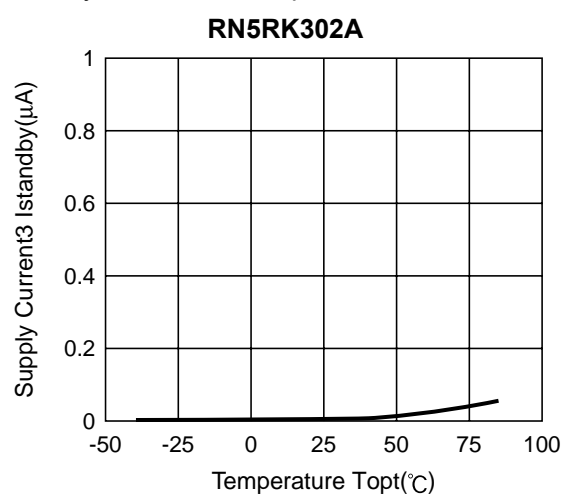

11) Oscillator Duty Cycle vs. Temperature

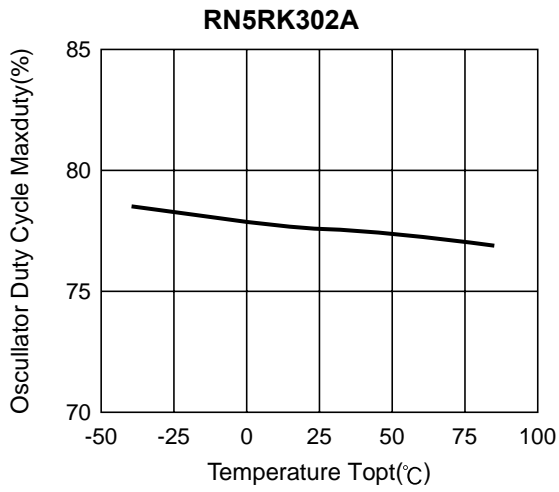

12) Maximum Oscillator Frequency vs. Temperature

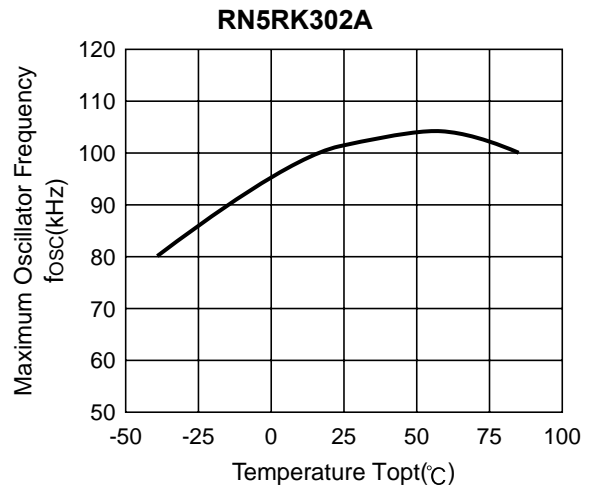

13) CE "H" Input Voltage vs. Temperature

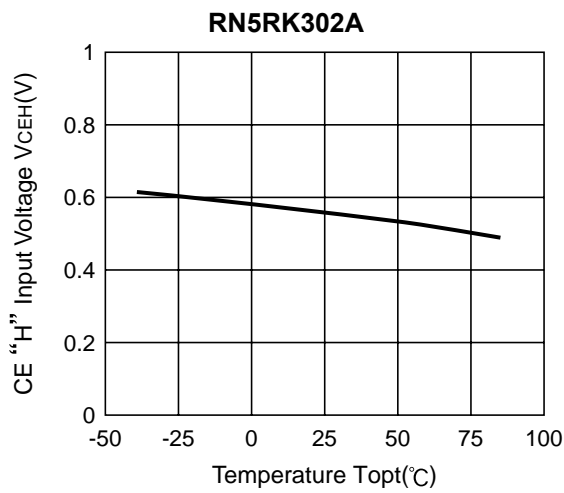

14) CE "L" Input Voltage vs. Temperature

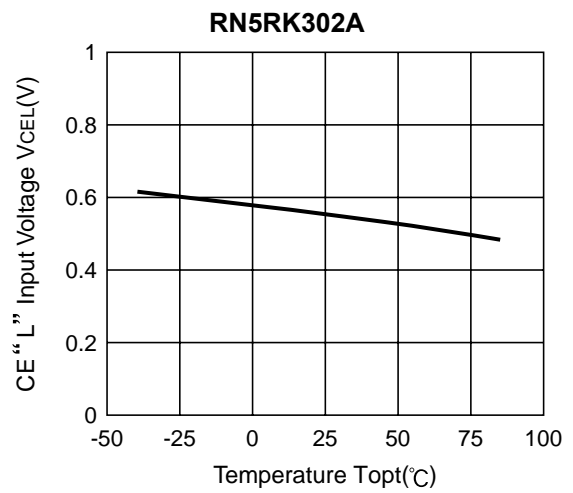

- SOT-23-5 (SC-74A)

Unit: mm

PACKAGE DIMENSIONS

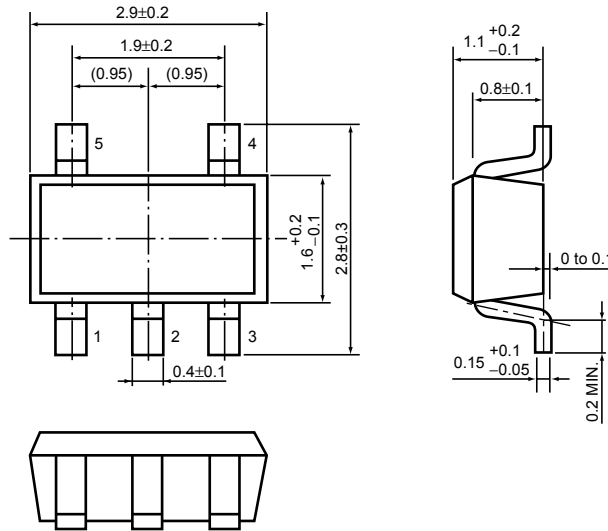

TAPING SPECIFICATION

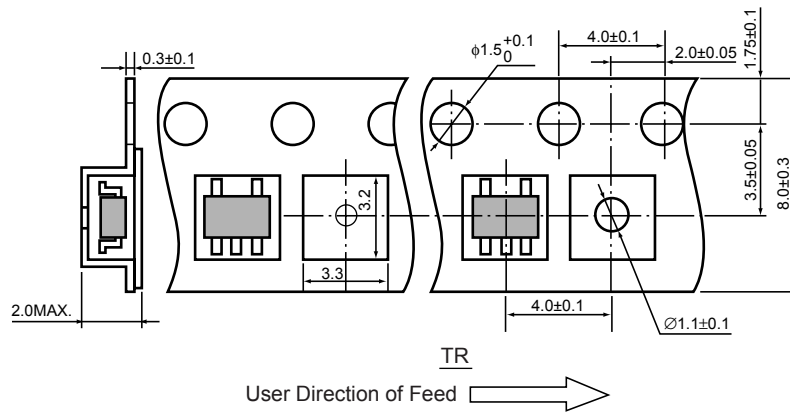

TAPING REEL DIMENSIONS

(1reel=3000pcs)

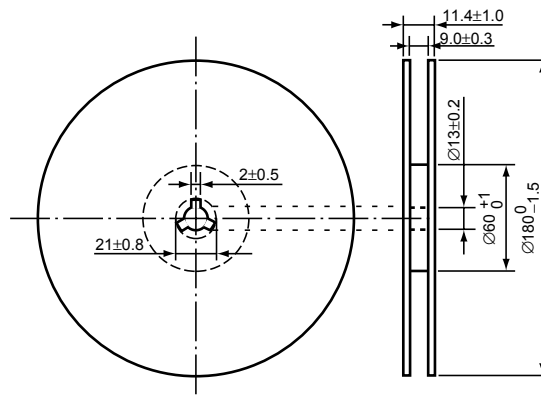

POWER DISSIPATION (SOT-23-5)

This specification is at mounted on board. Power Dissipation (P_D) depends on conditions of mounting on board. This specification is based on the measurement at the condition below:

(Power Dissipation (SOT-23-5) is substitution of SOT-23-6.)

Measurement Conditions

	Standard Land Pattern
Environment	Mounting on Board (Wind velocity=0m/s)
Board Material	Glass cloth epoxy plactic (Double sided)
Board Dimensions	40mm × 40mm × 1.6mm
Copper Ratio	Top side : Approx. 50% , Back side : Approx. 50%
Through-hole	φ0.5mm × 44pcs

Measurement Result

($T_{opt}=25^{\circ}C, T_{jmax}=125^{\circ}C$)

	Standard Land Pattern	Free Air
Power Dissipation	420mW	250mW
Thermal Resistance	$\theta_{ja}=(125-25^{\circ}C)/0.42W=263^{\circ}C/W$	400 $^{\circ}C/W$

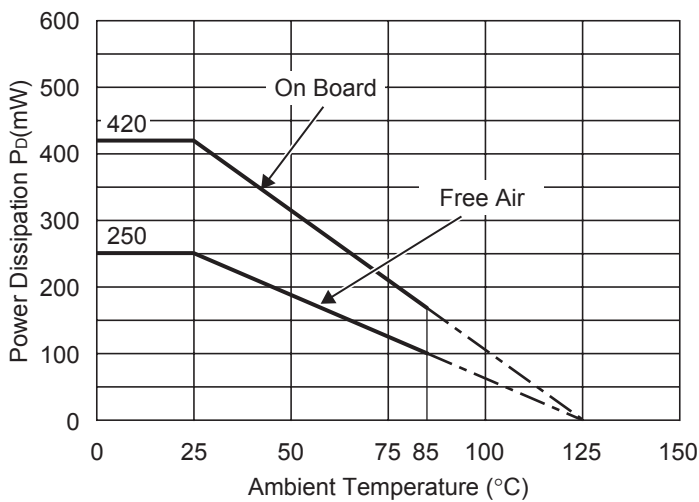

Power Dissipation

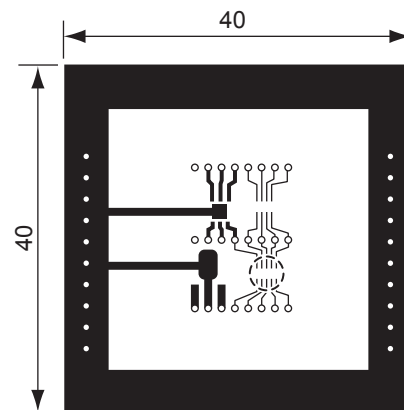

Measurement Board Pattern

○ IC Mount Area Unit : mm

RECOMMENDED LAND PATTERN

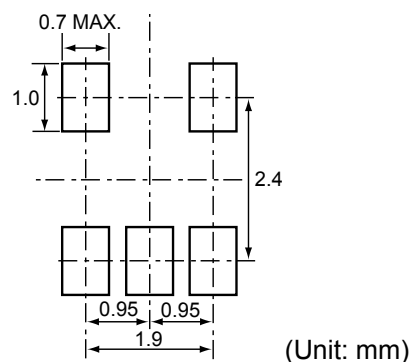

RN5RK SERIES MARK SPECIFICATION

● SOT-23-5 (SC-74A)

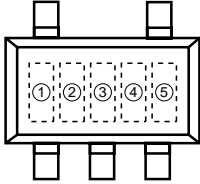

①, ② : Product Code (refer to Part Number vs. Product Code)

③, ④ : Lot Number

● Part Number vs. Product Code

Part Number	Product Code	
	①	②
RN5RK301A	W	A
RN5RK241A	W	B
RN5RK501A	W	C
RN5RK201A	W	D
RN5RK251A	W	E
RN5RK331A	W	F
RN5RK551A	W	G
RN5RK221A	W	H
RN5RK271A	W	J

Part Number	Product Code	
	①	②
RN5RK361A	W	K
RN5RK261A	W	L
RN5RK281A	W	M
RN5RK321A	W	N
RN5RK371A	W	P
RN5RK391A	W	Q
RN5RK271B	X	A
RN5RK201B	X	B
RN5RK221B	X	C

Part Number	Product Code	
	①	②
RN5RK251B	X	D
RN5RK301B	X	E
RN5RK331B	X	F
RN5RK361B	X	G
RN5RK501B	X	H
RN5RK551B	X	J
RN5RK391B	X	K
RN5RK202A	Y	A
RN5RK252A	Y	B

Part Number	Product Code	
	①	②
RN5RK272A	Y	C
RN5RK302A	Y	D
RN5RK332A	Y	E
RN5RK502A	Y	F
RN5RK552A	Y	G
RN5RK522A	Y	H
RN5RK222A	Y	J
RN5RK452A	Y	K