

Solder Preform PGA Sockets

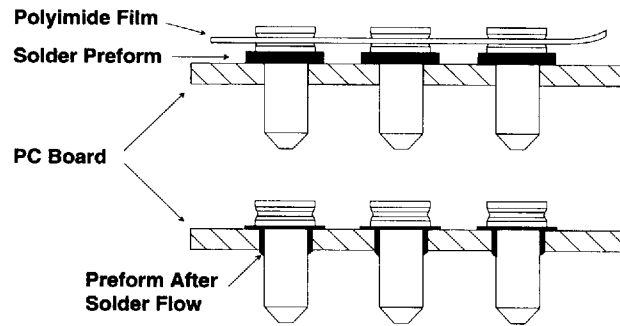
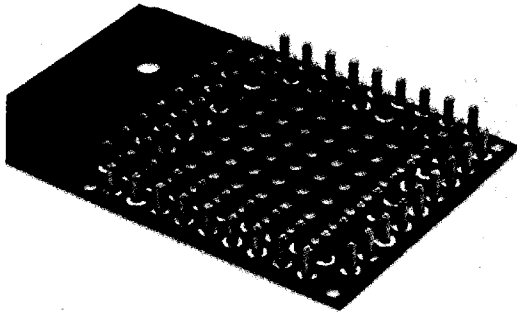

Features:

- Combines the labor of socket loading and solder application into one operation.
- Eliminates the use of solder paste and screening operation.
- Eliminates solder bridges and/or solder shorts due to excess solder.
- Insures a reliable solder joint with controlled solder volume.
- Ideal for surface mount and mixed technology applications.
- For custom solder preform terminal applications consult factory.
- Flux preforms available to customer requirements.
- See PGA pages 78 - 81 for additional material and dimensional information.

Terminals and Contacts:

Terminal: Brass - Copper Alloy 360, ASTM-B-16
 Contact: Beryllium Copper - Copper Alloy 172, ASTM-B-194

Plating:

Terminal: Gold over Nickel or Tin-Lead over Nickel
 Contact: Gold over Nickel or Tin-Lead over Nickel

Body Material:

HCS/HCSIS - High Temp. Glass Filled Thermoplastic, U.L. Rated 94V-O, -60°C to 260°C (-76°F to 500°F)

KS/KIS - Polyimide Film
 -269°C to 400°C (-452°F to 752°F)

Solder Preform:

63% Tin, 37% Lead, RMA flux optional

Terminal Information

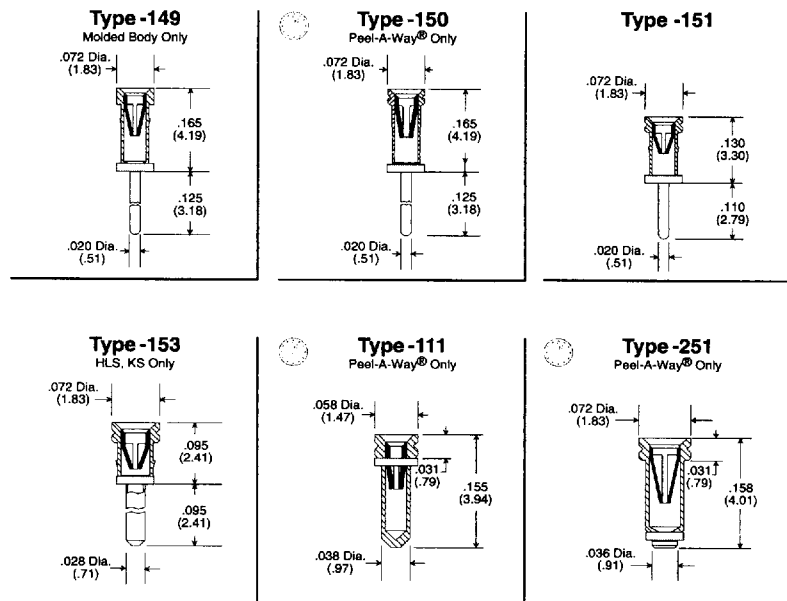

Quick turn delivery available on standard terminal types.

Additional terminal types available.

See terminal section for detailed terminal information.

How To Order

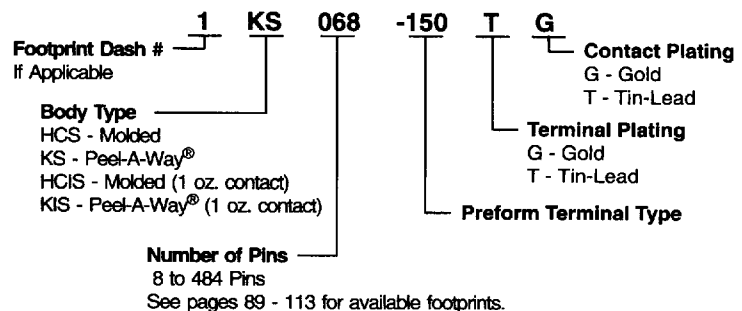

inch/(mm)

Solder Preform Terminals and Peel-A-Way® covered by patent rights issued and or pending.

D 16F 0255982 0001180 382

Pin Grid Array

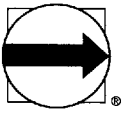

PGA Socket and Adapter Footprints

<p>8 Pins Footprint Number 8*</p> <p>3 x 3 rows</p>	<p>9 Pins Footprint Number 9*</p> <p>3 x 3 rows</p>	<p>10 Pins Footprint Number 10*</p> <p>4 x 3 rows</p>	<p>12 Pins Footprint Number 12*</p> <p>5 x 5 rows</p>	<p>20 Pins Footprint Number 20*</p> <p>5 x 5 rows</p>
<p>20 Pins Footprint Number 20-2*</p> <p>5 x 4 rows</p>	<p>21 Pins Footprint Number 21*</p> <p>5 x 5 rows</p>	<p>22 Pins Footprint Number 22*</p> <p>5 x 5 rows</p>	<p>23 Pins Footprint Number 23*</p> <p>5 x 5 rows</p>	<p>24 Pins Footprint Number 24*</p> <p>5 x 5 rows</p>
<p>25 Pins Footprint Number 25*</p> <p>5 x 5 rows</p>	<p>28 Pins Footprint Number 28*</p> <p>6 x 6 rows</p>	<p>28 Pins Footprint Number 28-1*</p> <p>7 x 7 rows</p>	<p>28 Pins Footprint Number 28-2*</p> <p>5 x 6 rows</p>	<p>28 Pins Footprint Number 28-3</p> <p>9 x 9 rows</p>
<p>29 Pins Footprint Number 29*</p> <p>6 x 6 rows</p>	<p>32 Pins Footprint Number 32</p> <p>9 x 9 rows</p>	<p>32 Pins Footprint Number 32-1*</p> <p>9 x 11 rows</p>	<p>32 Pins Footprint Number 32-2*</p> <p>6 x 7 rows</p>	<p>32 Pins Footprint Number 32-3*</p> <p>7 x 7 rows</p>

* Not Currently Available in Molded Body.
For Ordering Information See Page 78 - 88. For cutout windows requirements consult factory.

inch/(mm)

D 16F ■ 0255982 0001184 T28 ■

Page 89

Pin Grid Array

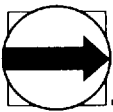

PGA Socket and Adapter Footprints

<p>36 Pins Footprint Number 36</p> <p>10 x 10 rows</p>	<p>36 Pins Footprint Number 36-1*</p> <p>6 x 6 rows</p>	<p>37 Pins Footprint Number 37</p> <p>10 x 10 rows</p>	<p>40 Pins Footprint Number 40</p> <p>11 x 11 rows</p>	<p>40 Pins Footprint Number 40-1*</p> <p>7 x 7 rows</p>
<p>40 Pins Footprint Number 40-2*</p> <p>7 x 9 rows</p>	<p>40 Pins Footprint Number 40-3*</p> <p>8 x 8 rows</p>	<p>42 Pins Footprint Number 42-1*</p> <p>7 x 6 rows</p>	<p>43 Pins Footprint Number 43*</p> <p>13 x 11 rows</p>	<p>44 Pins Footprint Number 44*</p> <p>8 x 8 rows</p>
<p>44 Pins Footprint Number 44-1</p> <p>11 x 11 rows</p>	<p>44 Pins Footprint Number 44-2</p> <p>12 x 12 rows</p>	<p>44 Pins Footprint Number 44-3*</p> <p>8 x 8 rows</p>	<p>44 Pins Footprint Number 44-4*</p> <p>8 x 8 rows</p>	<p>44 Pins Footprint Number 44-5</p> <p>9 x 9 rows</p>
<p>44 Pins Footprint Number 44-6</p> <p>10 x 10 rows</p>	<p>44 Pins Footprint Number 44-7</p> <p>10 x 10 rows</p>	<p>44 Pins Footprint Number 44-9</p> <p>13 x 13 rows</p>	<p>45 Pins Footprint Number 45*</p> <p>8 x 8 rows</p>	<p>45 Pins Footprint Number 45-1*</p> <p>8 x 8 rows</p>

* Not Currently Available in Molded Body.
For Ordering Information See Page 78 - 88. For cutout window consult factory.



PGA Socket and Adapter Footprints

<p>45 Pins Footprint Number 45-2*</p> <p>8 x 8 rows</p>	<p>47 Pins Footprint Number 47*</p> <p>8 x 8 rows</p>	<p>48 Pins Footprint Number 48</p> <p>9 x 9 rows</p>	<p>48 Pins Footprint Number 48-1</p> <p>13 x 13 rows</p>	<p>48 Pins Footprint Number 48-2*</p> <p>8 x 8 rows</p>
<p>48 Pins Footprint Number 48-3*</p> <p>8 x 8 rows</p>	<p>48 Pins Footprint Number 48-4</p> <p>10 x 10 rows</p>	<p>49 Pins Footprint Number 49</p> <p>9 x 9 rows</p>	<p>49 Pins Footprint Number 49-1</p> <p>14 x 14 rows</p>	<p>49 Pins Footprint Number 49-2*</p> <p>7 x 7 rows</p>
<p>49 Pins Footprint Number 49-3</p> <p>9 x 9 rows</p>	<p>50 Pins Footprint Number 50</p> <p>14 x 14 rows</p>	<p>50 Pins Footprint Number 50-1</p> <p>9 x 9 rows</p>	<p>50 Pins Footprint Number 50-2*</p> <p>5 x 10 rows</p>	<p>52 Pins Footprint Number 52</p> <p>9 x 9 rows</p>
<p>52 Pins Footprint Number 52-1</p> <p>13 x 13 rows</p>	<p>52 Pins Footprint Number 52-2</p> <p>9 x 9 rows</p>	<p>52 Pins Footprint Number 52-3</p> <p>11 x 11 rows</p>	<p>52 Pins Footprint Number 52-4</p> <p>12 x 12 rows</p>	<p>53 Pins Footprint Number 53</p> <p>9 x 9 rows</p>

* Not Currently Available in Molded Body.
For Ordering Information See Page 78 - 88. For cutout windows requirements consult factory.

inch/(mm)

D 16F ■ 0255982 0001186 8T0 ■

Page 91

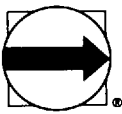

PGA Socket and Adapter Footprints

<p>53 Pins Footprint Number 53-1</p> <p>9 x 9 rows</p>	<p>53 Pins Footprint Number 53-2</p> <p>9 x 9 rows</p>	<p>54 Pins Footprint Number 54</p> <p>10 x 10 rows</p>	<p>56 Pins Footprint Number 56</p> <p>9 x 9 rows</p>	<p>56 Pins Footprint Number 56-1*</p> <p>10 x 20 rows</p>
<p>56 Pins Footprint Number 56-2</p> <p>15 x 15 rows</p>	<p>57 Pins Footprint Number 57</p> <p>9 x 9 rows</p>	<p>64 Pins Footprint Number 64</p> <p>10 x 10 rows</p>	<p>64 Pins Footprint Number 64-1*</p> <p>8 x 8 rows</p>	<p>64 Pins Footprint Number 64-2</p> <p>11 x 11 rows</p>
<p>64 Pins Footprint Number 64-3</p> <p>17 x 17 rows</p>	<p>64 Pins Footprint Number 64-4</p> <p>10 x 10 rows</p>	<p>64 Pins Footprint Number 64-5*</p> <p>12 x 10 rows</p>	<p>64 Pins Footprint Number 64-6</p> <p>10 x 10 rows</p>	<p>64 Pins Footprint Number 64-7*</p> <p>13 x 10 rows</p>
<p>64 Pins Footprint Number 64-8*</p> <p>24 x 16 rows</p>	<p>65 Pins Footprint Number 65</p> <p>11 x 11 rows</p>	<p>65 Pins Footprint Number 65-1</p> <p>10 x 10 rows</p>	<p>65 Pins Footprint Number 65-3</p> <p>9 x 9 rows</p>	<p>66 Pins Footprint Number 66</p> <p>11 x 11 rows</p>

* Not Currently Available in Molded Body.

For Ordering Information See Page 78 - 88. For cutout window consult factory.

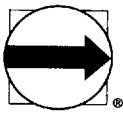

PGA Socket and Adapter Footprints

<p>66 Pins Footprint Number 66-1</p> <p>11 x 11 rows</p>	<p>67 Pins Footprint Number 67</p> <p>11 x 11 rows</p>	<p>67 Pins Footprint Number 67-1</p> <p>10 x 10 rows</p>	<p>68 Pins Footprint Number 68</p> <p>11 x 11 rows</p>	<p>68 Pins Footprint Number 68-1</p> <p>10 x 10 rows</p>
<p>68 Pins Footprint Number 68-2</p> <p>14 x 14 rows</p>	<p>68 Pins Footprint Number 68-3*</p> <p>19 x 19 rows</p>	<p>68 Pins Footprint Number 68-4</p> <p>11 x 11 rows</p>	<p>68 Pins Footprint Number 68-5*</p> <p>10 x 12 rows</p>	<p>69 Pins Footprint Number 69</p> <p>11 x 11 rows</p>
<p>69 Pins Footprint Number 69-1</p> <p>9 x 9 rows</p>	<p>69 Pins Footprint Number 69-2</p> <p>11 x 11 rows</p>	<p>69 Pins Footprint Number 69-4</p> <p>18 x 18 rows</p>	<p>70 Pins Footprint Number 70</p> <p>11 x 11 rows</p>	<p>70 Pins Footprint Number 70-1</p> <p>10 x 10 rows</p>
<p>70 Pins Footprint Number 70-2</p> <p>11 x 11 rows</p>	<p>71 Pins Footprint Number 71</p> <p>11 x 11 rows</p>	<p>72 Pins Footprint Number 72</p> <p>11 x 11 rows</p>	<p>72 Pins Footprint Number 72-1</p> <p>11 x 11 rows</p>	<p>72 Pins Footprint Number 72-2</p> <p>9 x 9 rows</p>

Pin Grid Array

* Not Currently Available in Molded Body.
For Ordering Information See Page 78 - 88. For cutout window consult factory.

inch/(mm)

D 16F ■ 0255982 0001188 673 ■

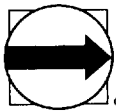

PGA Socket and Adapter Footprints

<p>72 Pins Footprint Number 72-3</p> <p>11 x 11 rows</p>	<p>72 Pins Footprint Number 72-4</p> <p>10 x 10 rows</p>	<p>72 Pins Footprint Number 72-5</p> <p>19 x 19 rows</p>	<p>73 Pins Footprint Number 73</p> <p>11 x 11 rows</p>	<p>73 Pins Footprint Number 73-1</p> <p>11 x 11 rows</p>
<p>73 Pins Footprint Number 73-2</p> <p>13 x 13 rows</p>	<p>73 Pins Footprint Number 73</p> <p>11 X 11 rows</p>	<p>74 Pins Footprint Number 74</p> <p>11 X 11 rows</p>	<p>74-1 Pins Footprint Number 74-1</p> <p>11 X 11 rows</p>	<p>74 Pins Footprint Number 74-2</p> <p>11 X 11 rows</p>
<p>74 Pins Footprint Number 74-3</p> <p>13 X 13 rows</p>	<p>75 Pins Footprint Number 75</p> <p>9 X 9 rows</p>	<p>75 Pins Footprint Number 75-1</p> <p>11 X 11 rows</p>	<p>75 Pins Footprint Number 75-2</p> <p>15 x 15 rows</p>	<p>75 Pins Footprint Number 75-3</p> <p>11 x 11 rows</p>
<p>76 Pins Footprint Number 76</p> <p>12 x 12 rows</p>	<p>76 Pins Footprint Number 76-1</p> <p>9 x 9 rows</p>	<p>76 Pins Footprint Number 76-2</p> <p>9 x 9 rows</p>	<p>76 Pins Footprint Number 76-3</p> <p>11 x 11 rows</p>	<p>80 Pins Footprint Number 80</p> <p>12 x 12 rows</p>

* Not Currently Available in Molded Body.

For Ordering Information See Page 78 - 88. For cutout window consult factory.

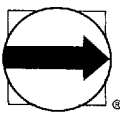

PGA Socket and Adapter Footprints

<p>80 Pins Footprint Number 80-1</p> <p>11 x 11 rows</p>	<p>80 Pins Footprint Number 80-2</p> <p>11 x 11 rows</p>	<p>80 Pins Footprint Number 80-3</p> <p>12 x 12 rows</p>	<p>80 Pins Footprint Number 80-4</p> <p>14 x 12 rows</p>	<p>80 Pins Footprint Number 80-5</p> <p>12 x 12 rows</p>
<p>80 Pins Footprint Number 80-6</p> <p>14 x 12 rows</p>	<p>80 Pins Footprint Number 80-7*</p> <p>8 x 10 rows</p>	<p>81 Pins Footprint Number 81</p> <p>9 x 9 rows</p>	<p>81 Pins Footprint Number 81-1</p> <p>11 x 11 rows</p>	<p>83 Pins Footprint Number 83</p> <p>11 x 11 rows</p>
<p>84 Pins Footprint Number 84</p> <p>10 x 10 rows</p>	<p>84 Pins Footprint Number 84-1</p> <p>12 x 12 rows</p>	<p>84 Pins Footprint Number 84-2</p> <p>13 x 13 rows</p>	<p>84 Pins Footprint Number 84-3</p> <p>11 x 11 rows</p>	<p>84 Pins Footprint Number 84-4</p> <p>11 x 11 rows</p>
<p>84 Pins Footprint Number 84-5</p> <p>15 x 15 rows</p>	<p>84 Pins Footprint Number 84-6</p> <p>11 x 11 rows</p>	<p>84 Pins Footprint Number 84-7</p> <p>12 x 12 rows</p>	<p>84 Pins Footprint Number 84-8</p> <p>12 x 12 rows</p>	<p>84 Pins Footprint Number 84-9</p> <p>11 x 11 rows</p>

* Not Currently Available in Molded Body.
For Ordering Information See Page 78 - 88. For cutout window consult factory.

inch/(mm)

D 16F ■ 0255982 0001190 221 ■

Page 95

Pin Grid Array

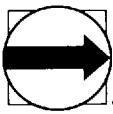

PGA Socket and Adapter Footprints

<p>84 Pins Footprint Number 84-10*</p> <p>12 x 7 rows</p>	<p>84 Pins Footprint Number 84-11*</p> <p>15 x 14 rows</p>	<p>85 Pins Footprint Number 85</p> <p>11 x 11 rows</p>	<p>85 Pins Footprint Number 85-1</p> <p>13 x 13 rows</p>	<p>85 Pins Footprint Number 85-2</p> <p>13 x 13 rows</p>
<p>85 Pins Footprint Number 85-3</p> <p>11 x 11 rows</p>	<p>85 Pins Footprint Number 85-4</p> <p>10 x 10 rows</p>	<p>85 Pins Footprint Number 85-5</p> <p>11 x 11 rows</p>	<p>85 Pins Footprint Number 85-6</p> <p>11 x 11 rows</p>	<p>85 Pins Footprint Number 85-7</p> <p>11 x 11 rows</p>
<p>88 Pins Footprint Number 88</p> <p>13 x 13 rows</p>	<p>88 Pins Footprint Number 88-1</p> <p>12 x 12 rows</p>	<p>88 Pins Footprint Number 88-2</p> <p>12 x 12 rows</p>	<p>88 Pins Footprint Number 88-3</p> <p>10 x 10 rows</p>	<p>88 Pins Footprint Number 88-4</p> <p>13 x 13 rows</p>
<p>89 Pins Footprint Number 89</p> <p>12 x 12 rows</p>	<p>89 Pins Footprint Number 89-1</p> <p>12 x 12 rows</p>	<p>89 Pins Footprint Number 89-2</p> <p>13 x 13 rows</p>	<p>90 Pins Footprint Number 90*</p> <p>5 x 18 rows</p>	<p>92 Pins Footprint Number 92</p> <p>10 x 10 rows</p>

* Not Currently Available in Molded Body.
For Ordering Information See Page 78 - 88. For cutout window consult factory.

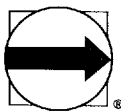

PGA Socket and Adapter Footprints

<p>92 Pins Footprint Number 92-1</p> <p>11 x 11 rows</p>	<p>92 Pins Footprint Number 92-2</p> <p>13 x 13 rows</p>	<p>94 Pins Footprint Number 94</p> <p>12 x 12 rows</p>	<p>95 Pins Footprint Number 95</p> <p>14 x 14 rows</p>	<p>95 Pins Footprint Number 95-1</p> <p>19 x 19 rows</p>
<p>96 Pins Footprint Number 96</p> <p>11 x 11 rows</p>	<p>96 Pins Footprint Number 96-1</p> <p>13 x 13 rows</p>	<p>96 Pins Footprint Number 96-2</p> <p>14 x 14 rows</p>	<p>96 Pins Footprint Number 96-3</p> <p>14 x 14 rows</p>	<p>97 Pins Footprint Number 97</p> <p>13 x 13 rows</p>
<p>97 Pins Footprint Number 97-1</p> <p>11 x 11 rows</p>	<p>100 Pins Footprint Number 100</p> <p>10 x 10 rows</p>	<p>100 Pins Footprint Number 100-1</p> <p>15 x 15 rows</p>	<p>100 Pins Footprint Number 100-2</p> <p>13 x 13 rows</p>	<p>100 Pins Footprint Number 100-3</p> <p>11 x 11 rows</p>
<p>100 Pins Footprint Number 100-4*</p> <p>17 x 11 rows</p>	<p>100 Pins Footprint Number 100-5</p> <p>14 x 14 rows</p>	<p>100 Pins Footprint Number 100-6</p> <p>13 x 13 rows</p>	<p>100 Pins Footprint Number 100-7</p> <p>13 x 13 rows</p>	<p>100 Pins Footprint Number 100-8</p> <p>14 x 14 rows</p>

* Not Currently Available in Molded Body.
For Ordering Information See Page 78 - 88. For cutout window consult factory.

inch/(mm)

Page 97

D 16F ■ 0255982 0001192 0T4 ■

Pin Grid Array

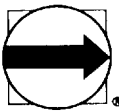

PGA Socket and Adapter Footprints

<p>100 Pins Footprint Number 100-9</p> <p>12 x 12 rows</p>	<p>100 Pins Footprint Number 100-10</p> <p>13 x 13 rows</p>	<p>100 Pins Footprint Number 100-11*</p> <p>13 x 12 rows</p>	<p>100 Pins Footprint Number 100-12*</p> <p>13 x 15 rows</p>	<p>100 Pins Footprint Number 100-13*</p> <p>15 x 13 rows</p>
<p>100 Pins Footprint Number 100-14*</p> <p>11 x 13 rows</p>	<p>100 Pins Footprint Number 100-15</p> <p>13 x 13 rows</p>	<p>100 Pins Footprint Number 100-16</p> <p>13 x 13 rows</p>	<p>100 Pins Footprint Number 100-17</p> <p>13 x 13 rows</p>	<p>101 Pins Footprint Number 101</p> <p>13 x 13 rows</p>
<p>101 Pins Footprint Number 101-1</p> <p>14 x 14 rows</p>	<p>101 Pins Footprint Number 101-2</p> <p>15 x 15 rows</p>	<p>101 Pins Footprint Number 101-3</p> <p>13 x 13 rows</p>	<p>101 Pins Footprint Number 101-4</p> <p>13 x 13 rows</p>	<p>101 Pins Footprint Number 101-5</p> <p>12 x 12 rows</p>
<p>102 Pins Footprint Number 102</p> <p>13 x 13 rows</p>	<p>104 Pins Footprint Number 104</p> <p>14 x 14 rows</p>	<p>104 Pins Footprint Number 104-1</p> <p>13 x 13 rows</p>	<p>104 Pins Footprint Number 104-2</p> <p>15 x 15 rows</p>	<p>105 Pins Footprint Number 105</p> <p>19 x 19 rows</p>

* Not Currently Available in Molded Body.

For Ordering Information See Page 78 - 88. For cutout window consult factory.

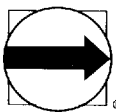

PGA Socket and Adapter Footprints

<p>107 Pins Footprint Number 107</p> <p>12 x 12 rows</p>	<p>108 Pins Footprint Number 108</p> <p>12 x 12 rows</p>	<p>108 Pins Footprint Number 108-1</p> <p>11 x 11 rows</p>	<p>109 Pins Footprint Number 109</p> <p>12 x 12 rows</p>	<p>112 Pins Footprint Number 112</p> <p>11 x 11 rows</p>
<p>112 Pins Footprint Number 112-1</p> <p>16 x 16 rows</p>	<p>113 Pins Footprint Number 113</p> <p>11 x 11 rows</p>	<p>114 Pins Footprint Number 114-2</p> <p>13 x 13 rows</p>	<p>116 Pins Footprint Number 116</p> <p>11 x 11 rows</p>	<p>116 Pins Footprint Number 116-1*</p> <p>17 x 11 rows</p>
<p>117 Pins Footprint Number 117</p> <p>11 x 11 rows</p>	<p>119 Pins Footprint Number 119</p> <p>13 x 13 rows</p>	<p>119 Pins Footprint Number 119-1</p> <p>13 x 13 rows</p>	<p>120 Pins Footprint Number 120</p> <p>13 x 13 rows</p>	<p>120 Pins Footprint Number 120-1</p> <p>11 x 11 rows</p>
<p>120 Pins Footprint Number 120-2</p> <p>13 x 13 rows</p>	<p>120 Pins Footprint Number 120-4</p> <p>18 x 18 rows</p>	<p>120 Pins Footprint Number 120-5</p> <p>16 x 16 rows</p>	<p>121 Pins Footprint Number 121</p> <p>13 x 13 rows</p>	<p>121 Pins Footprint Number 121-1</p> <p>11 x 11 rows</p>

Pin Grid Array

* Not Currently Available in Molded Body.
For Ordering Information See Page 78 - 88. For cutout window consult factory.

inch/(mm)

Rev. 14-A Page 99

D 16F ■ 0255982 0001194 977 ■

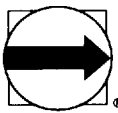

PGA Socket and Adapter Footprints

<p>122 Pins Footprint Number 122</p> <p>1.300 Sq. (33.02)</p> <p>.100/(2.54) Typ.</p> <p>13 x 13 rows</p>	<p>123 Pins Footprint Number 123*</p> <p>2.100 (53.34)</p> <p>.600 (15.24)</p> <p>.100/(2.54) Typ.</p> <p>21 x 6 rows</p>	<p>124 Pins Footprint Number 124</p> <p>1.300 Sq. (33.02)</p> <p>.100/(2.54) Typ.</p> <p>13 x 13 rows</p>	<p>124 Pins Footprint Number 124-1</p> <p>1.500 Sq. (38.10)</p> <p>.100/(2.54) Typ.</p> <p>15 x 15 rows</p>	<p>124 Pins Footprint Number 124-2</p> <p>1.800 Sq. (45.72)</p> <p>.100/(2.54) Typ.</p> <p>18 x 18 rows</p>
<p>124 Pins Footprint Number 124-3</p> <p>1.400 Sq. (35.56)</p> <p>.100/(2.54) Typ.</p> <p>14 x 14 rows</p>	<p>124 Pins Footprint Number 124-4</p> <p>1.200 Sq. (30.48)</p> <p>.100/(2.54) Typ.</p> <p>12 x 12 rows</p>	<p>125 Pins Footprint Number 125</p> <p>1.300 Sq. (33.02)</p> <p>.100/(2.54) Typ.</p> <p>13 x 13 rows</p>	<p>125 Pins Footprint Number 125-1</p> <p>1.300 Sq. (33.02)</p> <p>.100/(2.54) Typ.</p> <p>13 x 13 rows</p>	<p>125 Pins Footprint Number 125-2</p> <p>1.800 Sq. (45.72)</p> <p>.100/(2.54) Typ.</p> <p>18 x 18 rows</p>
<p>125 Pins Footprint Number 125-3</p> <p>1.400 Sq. (35.56)</p> <p>.100/(2.54) Typ.</p> <p>14 x 14 rows</p>	<p>128 Pins Footprint Number 128</p> <p>1.300 Sq. (33.02)</p> <p>.100/(2.54) Typ.</p> <p>13 x 13 rows</p>	<p>128 Pins Footprint Number 128-1</p> <p>1.300 Sq. (33.02)</p> <p>.100/(2.54) Typ.</p> <p>13 x 13 rows</p>	<p>128 Pins Footprint Number 128-2</p> <p>1.700 Sq. (43.18)</p> <p>.100/(2.54) Typ.</p> <p>17 x 17 rows</p>	<p>128 Pins Footprint Number 128-3</p> <p>1.300 Sq. (33.02)</p> <p>.100/(2.54) Typ.</p> <p>13 x 13 rows</p>
<p>128 Pins Footprint Number 128-4</p> <p>1.700 Sq. (43.18)</p> <p>.100/(2.54) Typ.</p> <p>17 x 17 rows</p>	<p>130 Pins Footprint Number 130</p> <p>1.300 Sq. (33.02)</p> <p>.100/(2.54) Typ.</p> <p>13 x 13 rows</p>	<p>131 Pins Footprint Number 131</p> <p>1.400 Sq. (35.56)</p> <p>.100/(2.54) Typ.</p> <p>14 x 14 rows</p>	<p>132 Pins Footprint Number 132</p> <p>1.400 Sq. (35.56)</p> <p>.100/(2.54) Typ.</p> <p>14 x 14 rows</p>	<p>132 Pins Footprint Number 132-1</p> <p>1.300 Sq. (33.02)</p> <p>.100/(2.54) Typ.</p> <p>13 x 13 rows</p>

* Not Currently Available in Molded Body.
For Ordering Information See Page 78 - 88. For cutout window consult factory.

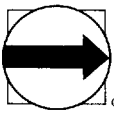

PGA Socket and Adapter Footprints

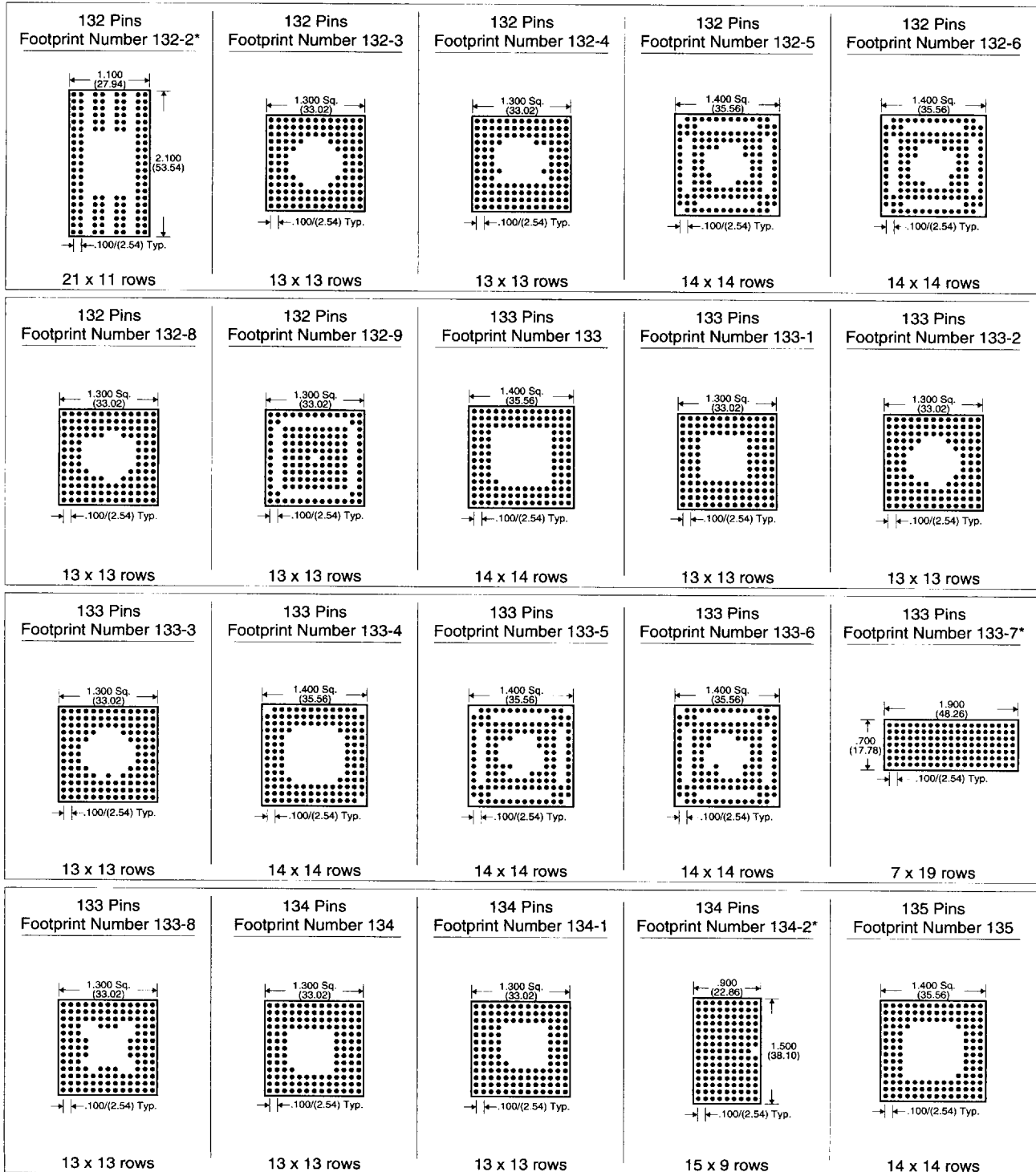

* Not Currently Available in Molded Body.

For Ordering Information See Page 78 - 88. For cutout window consult factory.

inch/(mm)

D 16F ■ 0255982 0001196 74T ■

Page 101

Pin Grid Area

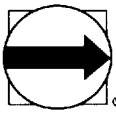

PGA Socket and Adapter Footprints

<p>135 Pins Footprint Number 135-1*</p> <p>15 x 9 rows</p>	<p>136 Pins Footprint Number 136</p> <p>14 x 14 rows</p>	<p>136 Pins Footprint Number 136-1</p> <p>19 x 19 rows</p>	<p>139 Pins Footprint Number 139</p> <p>14 x 14 rows</p>	<p>139 Pins Footprint Number 139-1</p> <p>14 x 14 rows</p>
<p>139 Pins Footprint Number 139-2*</p> <p>22 x 22 rows</p>	<p>141 Pins Footprint Number 141</p> <p>15 x 15 rows</p>	<p>142 Pins Footprint Number 142</p> <p>13 x 13 rows</p>	<p>142 Pins Footprint Number 142-1</p> <p>15 x 15 rows</p>	<p>142 Pins Footprint Number 142-2</p> <p>14 x 14 rows</p>
<p>142 Pins Footprint Number 142-3</p> <p>15 x 15 rows</p>	<p>143 Pins Footprint Number 143</p> <p>12 x 12 rows</p>	<p>143 Pins Footprint Number 143-1</p> <p>15 x 15 rows</p>	<p>144 Pins Footprint Number 144</p> <p>13 x 13 rows</p>	<p>144 Pins Footprint Number 144-1</p> <p>12 x 12 rows</p>
<p>144 Pins Footprint Number 144-2</p> <p>15 x 15 rows</p>	<p>144 Pins Footprint Number 144-3</p> <p>17 x 17 rows</p>	<p>144 Pins Footprint Number 144-5</p> <p>16 x 16 rows</p>	<p>144 Pins Footprint Number 144-6</p> <p>19 x 19 rows</p>	<p>144 Pins Footprint Number 144-7</p> <p>19 x 19 rows</p>

* Not Currently Available in Molded Body.
For Ordering Information See Page 78 - 88. For cutout window consult factory.

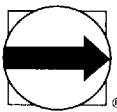

PGA Socket and Adapter Footprints

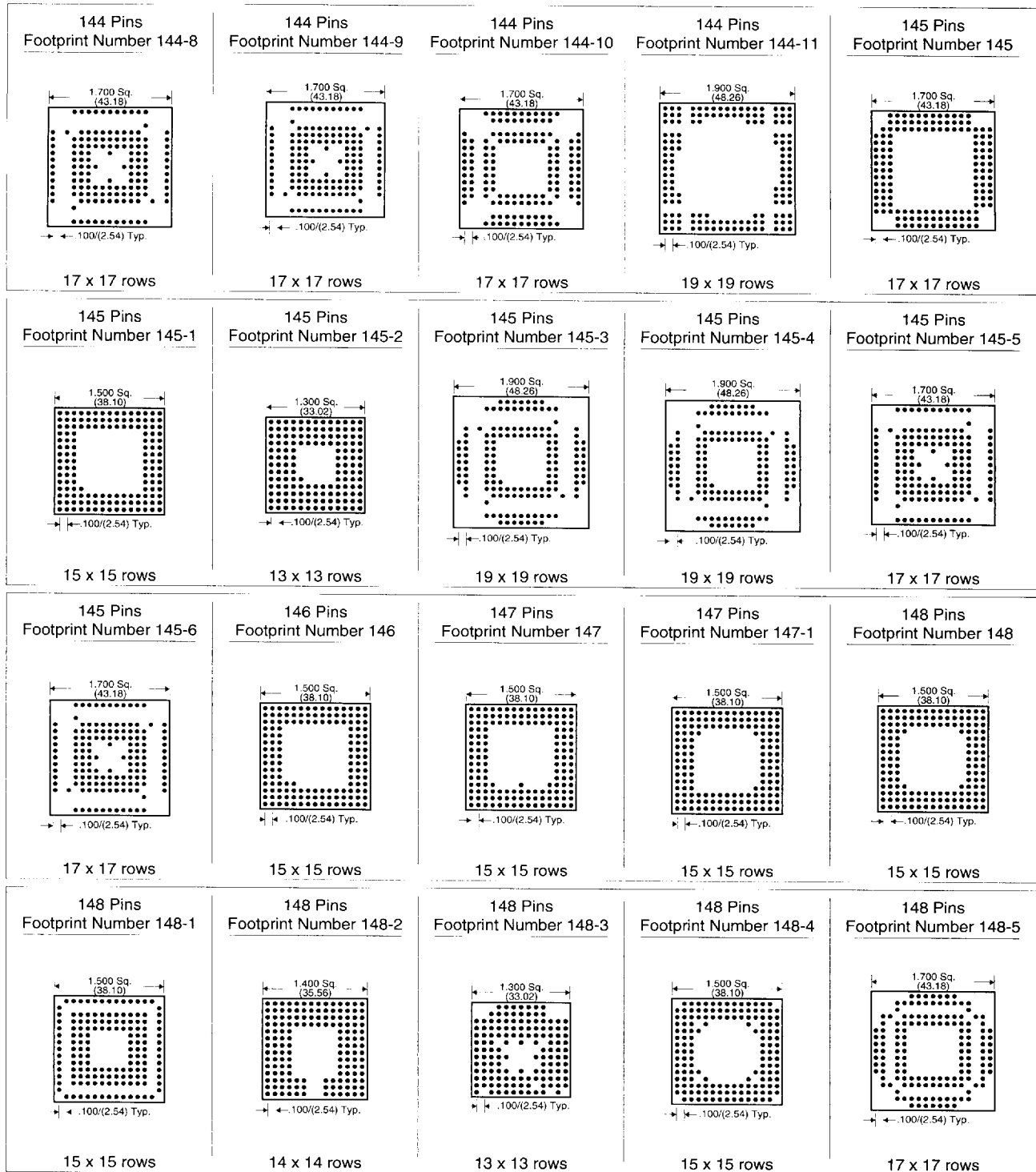

* Not Currently Available in Molded Body.
For Ordering Information See Page 78 - 88. For cutout window consult factory.

inch/(mm)

D 16F ■ 0255982 0001198 512 ■

Page 103

Pin Grid Array

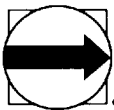

PGA Socket and Adapter Footprints

<p>148 Pins Footprint Number 148-6</p> <p>14 x 14 rows</p>	<p>149 Pins Footprint Number 149</p> <p>15 x 15 rows</p>	<p>149 Pins Footprint Number 149-1</p> <p>15 x 15 rows</p>	<p>149 Pins Footprint Number 149-3</p> <p>15 x 15 rows</p>	<p>149 Pins Footprint Number 149-4</p> <p>17 x 17 rows</p>
<p>150 Pins Footprint Number 150</p> <p>15 x 15 rows</p>	<p>152 Pins Footprint Number 152</p> <p>14 x 14 rows</p>	<p>153 Pins Footprint Number 153</p> <p>15 x 15 rows</p>	<p>155 Pins Footprint Number 155</p> <p>16 x 16 rows</p>	<p>156 Pins Footprint Number 156</p> <p>15 x 15 rows</p>
<p>156 Pins Footprint Number 156-1</p> <p>15 x 15 rows</p>	<p>156 Pins Footprint Number 156-2</p> <p>16 x 16 rows</p>	<p>157 Pins Footprint Number 157</p> <p>17 x 17 rows</p>	<p>159 Pins Footprint Number 159</p> <p>16 x 16 rows</p>	<p>160 Pins Footprint Number 160</p> <p>14 x 14 rows</p>
<p>160 Pins Footprint Number 160-1</p> <p>15 x 15 rows</p>	<p>160 Pins Footprint Number 160-2*</p> <p>24 x 24 rows</p>	<p>160 Pins Footprint Number 160-3</p> <p>14 x 14 rows</p>	<p>160 Pins Footprint Number 160-4</p> <p>19 x 19 rows</p>	<p>160 Pins Footprint Number 160-5</p> <p>17 x 17 rows</p>

* Not Currently Available in Molded Body.
For Ordering Information See Page 78 - 88. For cutout window consult factory.

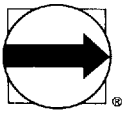

PGA Socket and Adapter Footprints

<p>160 Pins Footprint Number 160-6</p> <p>15 x 15 rows</p>	<p>160 Pins Footprint Number 160-7</p> <p>16 x 16 rows</p>	<p>161 Pins Footprint Number 161</p> <p>15 x 15 rows</p>	<p>161 Pins Footprint Number 161-1</p> <p>17 x 17 rows</p>	<p>161 Pins Footprint Number 161-2</p> <p>15 x 15 rows</p>
<p>162 Pins Footprint Number 162</p> <p>15 x 15 rows</p>	<p>162 Pins Footprint Number 162-2</p> <p>17 x 17 rows</p>	<p>164 Pins Footprint Number 164</p> <p>17 x 17 rows</p>	<p>164 Pins Footprint Number 164-1</p> <p>17 x 17 rows</p>	<p>164 Pins Footprint Number 164-2</p> <p>17 x 17 rows</p>
<p>164 Pins Footprint Number 164-3</p> <p>15 x 15 rows</p>	<p>165 Pins Footprint Number 165</p> <p>17 x 17 rows</p>	<p>165 Pins Footprint Number 165-1</p> <p>17 x 17 rows</p>	<p>165 Pins Footprint Number 165-2</p> <p>17 x 17 rows</p>	<p>167 Pins Footprint Number 167</p> <p>17 x 17 rows</p>
<p>168 Pins Footprint Number 168</p> <p>17 x 17 rows</p>	<p>169 Pins Footprint Number 169</p> <p>13 x 13 rows</p>	<p>169 Pins Footprint Number 169-1</p> <p>17 x 17 rows</p>	<p>171 Pins Footprint Number 171</p> <p>14 x 14 rows</p>	<p>172 Pins Footprint Number 172</p> <p>16 x 16 rows</p>

* Not Currently Available in Molded Body.
For Ordering Information See Page 78 - 88. For cutout window consult factory.

inch/(mm)

D 16F ■ 02559&2 0001200 T10 ■

Page 105

PIN GRID ARRAY

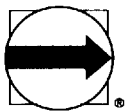

PGA Socket and Adapter Footprints

<p>172 Pins Footprint Number 172-1</p> <p>15 x 15 rows</p>	<p>172 Pins Footprint Number 172-3</p> <p>18 x 18 rows</p>	<p>173 Pins Footprint Number 173</p> <p>16 x 16 rows</p>	<p>173 Pins Footprint Number 173-1</p> <p>16 x 16 rows</p>	<p>173 Pins Footprint Number 173-2</p> <p>17 x 17 rows</p>
<p>175 Pins Footprint Number 175</p> <p>14 x 14 rows</p>	<p>175 Pins Footprint Number 175-3</p> <p>15 x 15 rows</p>	<p>175 Pins Footprint Number 175-4</p> <p>16 x 16 rows</p>	<p>175 Pins Footprint Number 175-5</p> <p>16 x 16 rows</p>	<p>176 Pins Footprint Number 176</p> <p>15 x 15 rows</p>
<p>176 Pins Footprint Number 176-1</p> <p>16 x 16 rows</p>	<p>177 Pins Footprint Number 177</p> <p>15 x 15 rows</p>	<p>179 Pins Footprint Number 179</p> <p>15 x 15 rows</p>	<p>179 Pins Footprint Number 179-1</p> <p>14 x 14 rows</p>	<p>179 Pins Footprint Number 179-2</p> <p>18 x 18 rows</p>
<p>179 Pins Footprint Number 179-3</p> <p>18 x 18 rows</p>	<p>180 Pins Footprint Number 180</p> <p>14 x 14 rows</p>	<p>180 Pins Footprint Number 180-1</p> <p>15 x 15 rows</p>	<p>180 Pins Footprint Number 180-2</p> <p>15 x 15 rows</p>	<p>180 Pins Footprint Number 180-3</p> <p>18 x 18 rows</p>

* Not Currently Available in Molded Body.
For Ordering Information See Page 78 - 88. For cutout window consult factory.

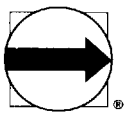

PGA Socket and Adapter Footprints

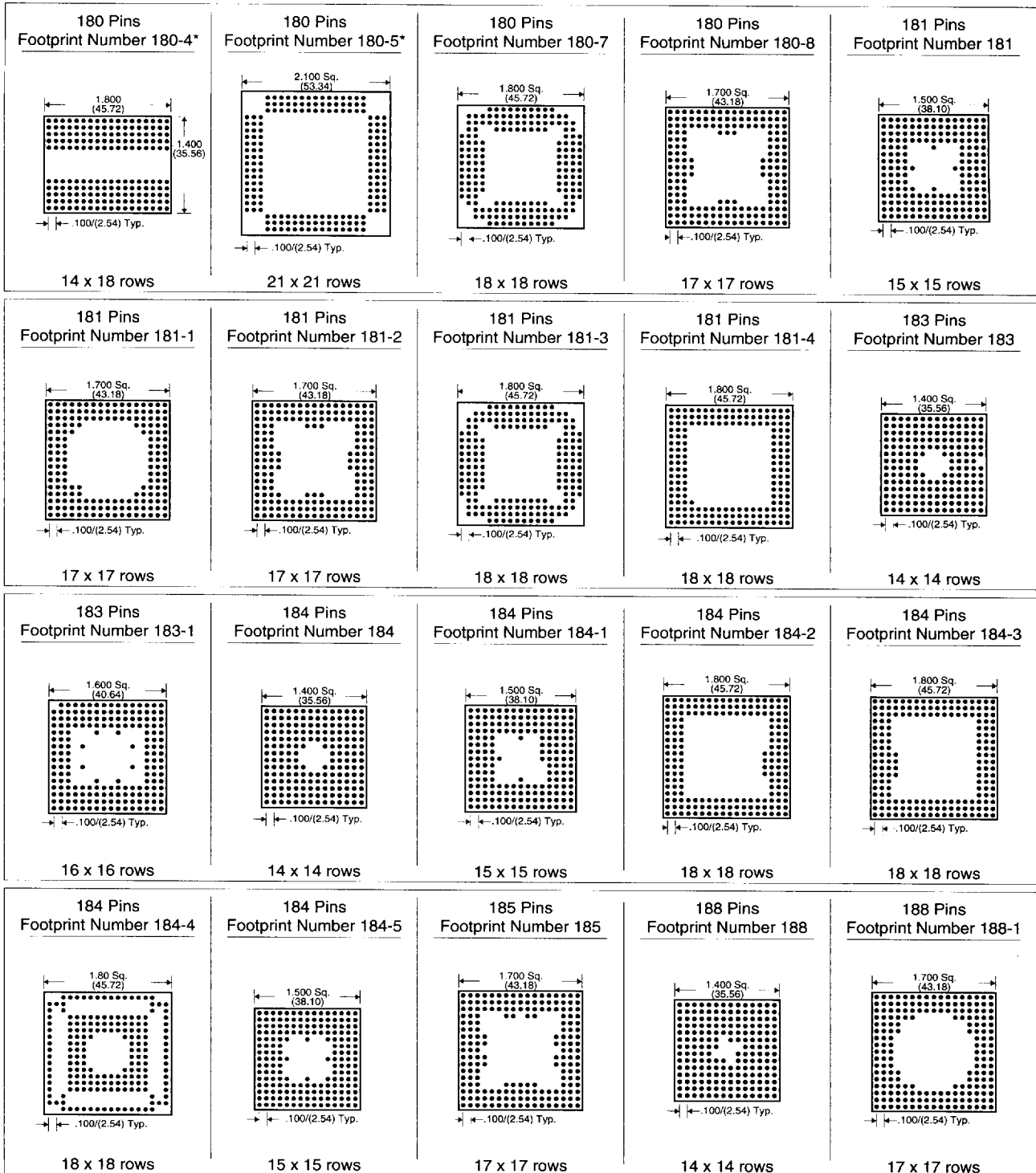

* Not Currently Available in Molded Body.
For Ordering Information See Page 78 - 88. For cutout window consult factory.

inch/(mm)

D 16F ■ 0255982 0001202 873 ■

Page 107

Pin Grid Array

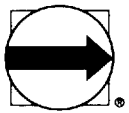

PGA Socket and Adapter Footprints

<p>188 Pins Footprint Number 188-2</p> <p>17 x 17 rows</p>	<p>189 Pins Footprint Number 189</p> <p>15 x 15 rows</p>	<p>190 Pins Footprint Number 190</p> <p>15 x 15 rows</p>	<p>191 Pins Footprint Number 191</p> <p>18 x 18 rows</p>	<p>192 Pins Footprint Number 192</p> <p>17 x 17 rows</p>
<p>192 Pins Footprint Number 192-1</p> <p>14 x 14 rows</p>	<p>193 Pins Footprint Number 193</p> <p>19 x 19 rows</p>	<p>195 Pins Footprint Number 195</p> <p>16 x 16 rows</p>	<p>196 Pins Footprint Number 196</p> <p>14 x 14 rows</p>	<p>196 Pins Footprint Number 196-1</p> <p>19 x 19 rows</p>
<p>196 Pins Footprint Number 196-2</p> <p>17 x 17 rows</p>	<p>197 Pins Footprint Number 197</p> <p>19 x 19 rows</p>	<p>200 Pins Footprint Number 200</p> <p>15 x 15 rows</p>	<p>202 Pins Footprint Number 202</p> <p>17 x 17 rows</p>	<p>204 Pins Footprint Number 204</p> <p>15 x 15 rows</p>
<p>204 Pins Footprint Number 204-1</p> <p>17 x 17 rows</p>	<p>206 Pins Footprint Number 206</p> <p>18 x 18 rows</p>	<p>207 Pins Footprint Number 207</p> <p>17 x 17 rows</p>	<p>208 Pins Footprint Number 208</p> <p>17 x 17 rows</p>	<p>208 Pins Footprint Number 208-1</p> <p>17 x 17 rows</p>

* Not Currently Available in Molded Body.
For Ordering Information See Page 78 - 88. For cutout window consult factory.

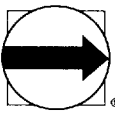

PGA Socket and Adapter Footprints

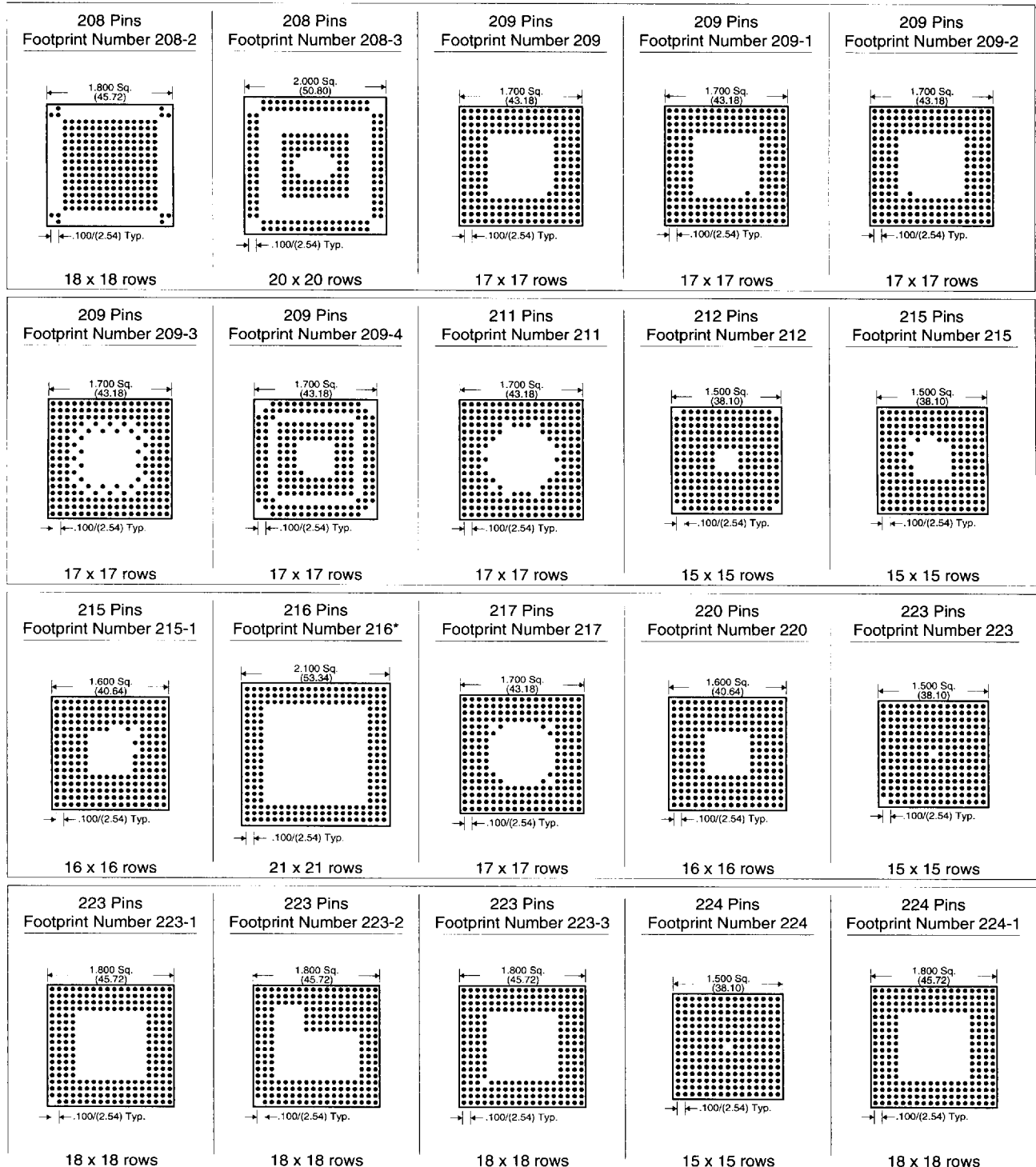

* Not Currently Available in Molded Body.

For Ordering Information See Page 78 - 88. For cutout window consult factory.

inch/(mm)

D 16F ■ 0255982 0001204 646 ■

Page 109

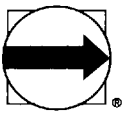

PGA Socket and Adapter Footprints

<p>224 Pins Footprint Number 224-2</p> <p>15 x 15 rows</p>	<p>224 Pins Footprint Number 224-3</p> <p>17 x 17 rows</p>	<p>225 Pins Footprint Number 225</p> <p>18 x 18 rows</p>	<p>225 Pins Footprint Number 225-1</p> <p>15 x 15 rows</p>	<p>225 Pins Footprint Number 225-2</p> <p>17 x 17 rows</p>
<p>228 Pins Footprint Number 228-1</p> <p>18 x 18 rows</p>	<p>229 Pins Footprint Number 229*</p> <p>21 x 21 rows</p>	<p>229 Pins Footprint Number 229-1</p> <p>19 x 19 rows</p>	<p>230 Pins Footprint Number 230</p> <p>17 x 17 rows</p>	<p>232 Pins Footprint Number 232</p> <p>17 x 17 rows</p>
<p>233 Pins Footprint Number 233</p> <p>17 x 17 rows</p>	<p>235 Pins Footprint Number 235</p> <p>18 x 18 rows</p>	<p>237 Pins Footprint Number 237</p> <p>17 x 17 rows</p>	<p>237 Pins Footprint Number 237-1</p> <p>19 x 19 rows</p>	<p>238 Pins Footprint Number 238</p> <p>19 x 19 rows</p>
<p>239 Pins Footprint Number 239</p> <p>19 x 19 rows</p>	<p>240 Pins Footprint Number 240</p> <p>17 x 17 rows</p>	<p>240 Pins Footprint Number 240-1*</p> <p>22 x 22 rows</p>	<p>241 Pins Footprint Number 241</p> <p>19 x 19 rows</p>	<p>241 Pins Footprint Number 241-1</p> <p>18 x 18 rows</p>

* Not Currently Available in Molded Body.
For Ordering Information See Page 78 - 88. For cutout window consult factory.

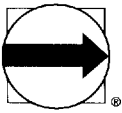

PGA Socket and Adapter Footprints

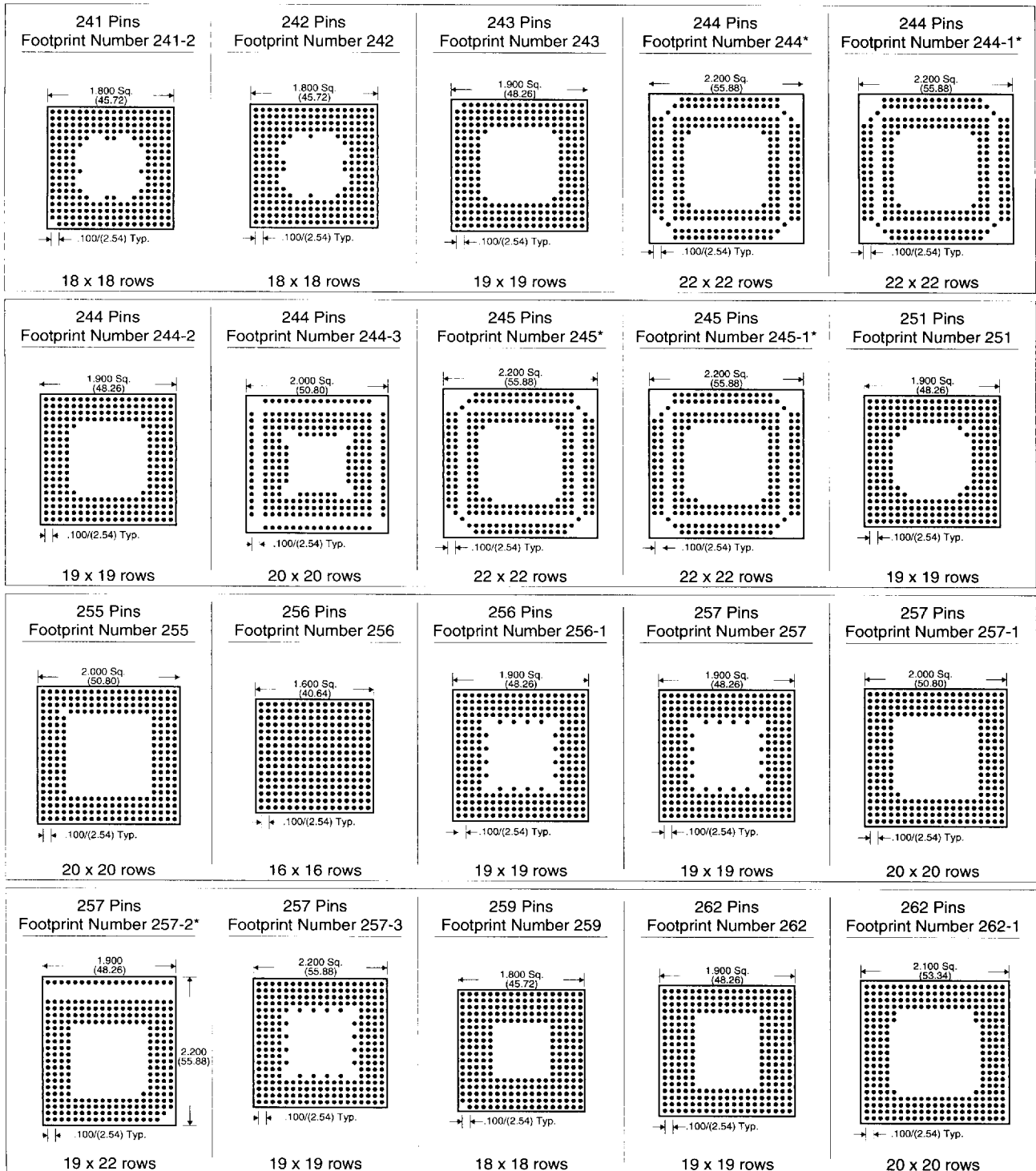

* Not Currently Available in Molded Body.
For Ordering Information See Page 78 - 88. For cutout window consult factory.

inch/(mm)

D 16F ■ 0255982 0001206 419 ■

Page 111

PIN GRID ARRAY

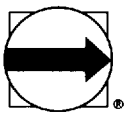

PGA Socket and Adapter Footprints

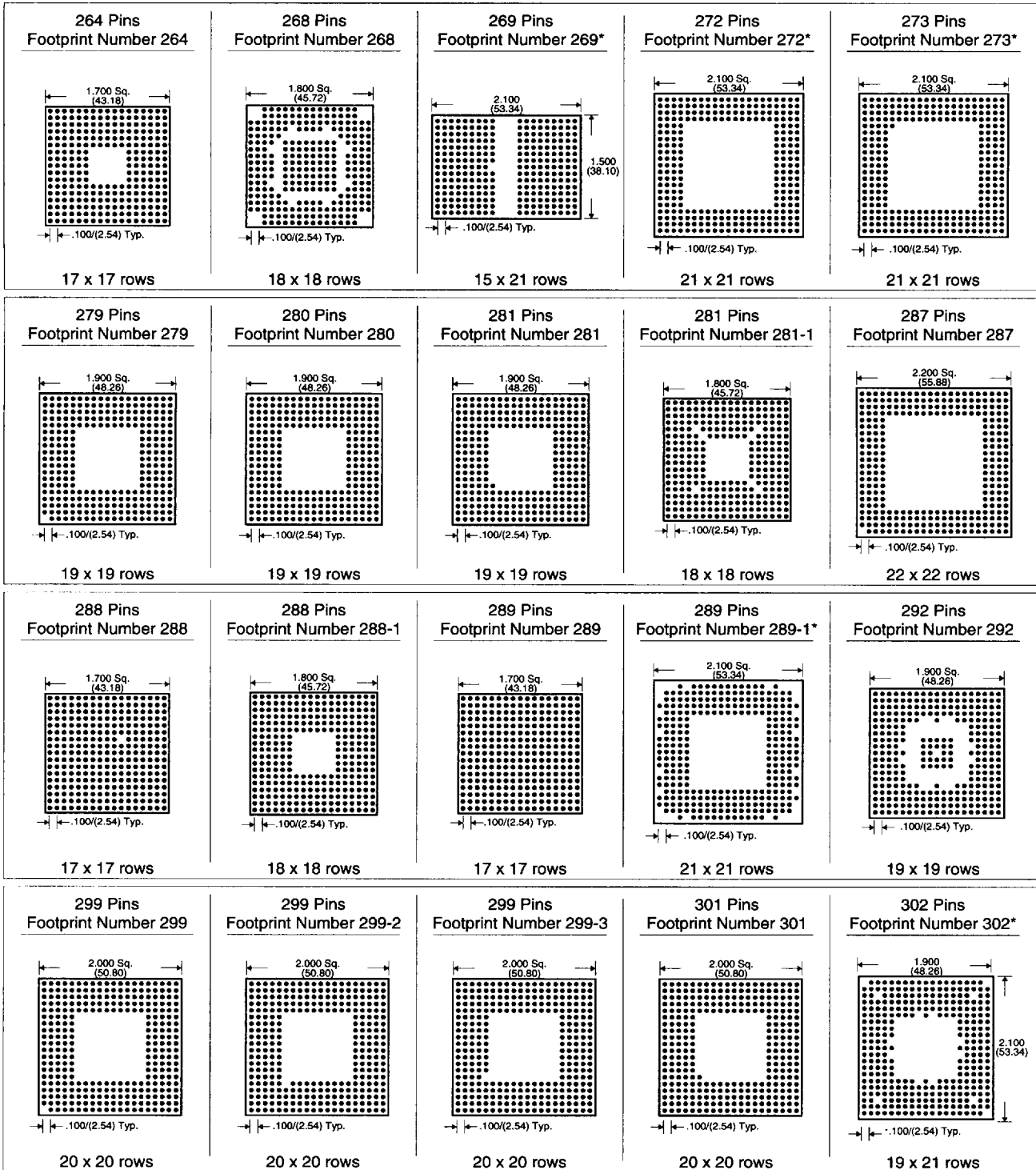

* Not Currently Available in Molded Body.
For Ordering Information See Page 78 - 88. For cutout window consult factory.

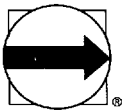

PGA Socket and Adapter Footprints

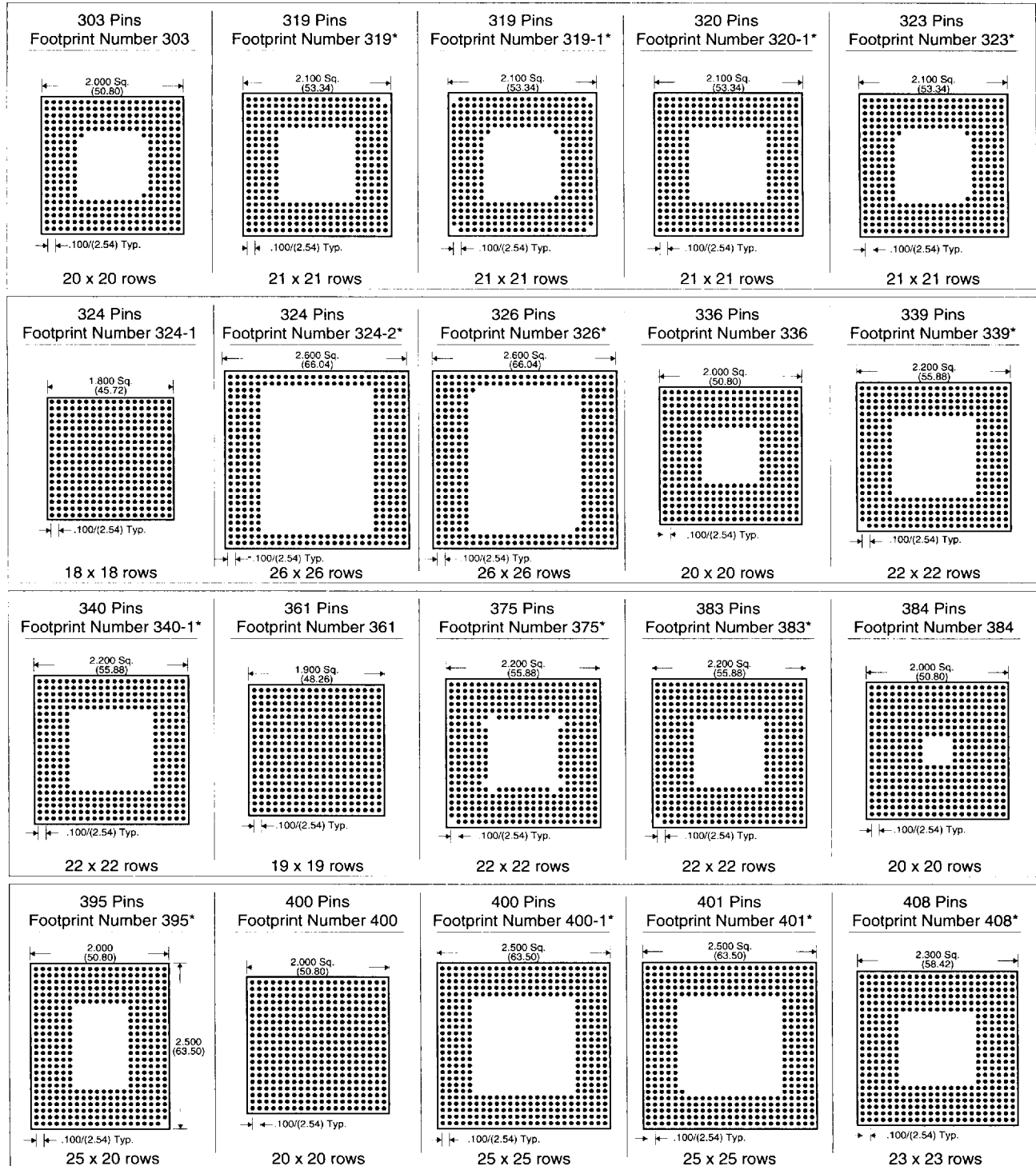

* Not Currently Available in Molded Body.

For Ordering Information See Page 78 - 88. For cutout window consult factory.

inch/(mm)

D 16F ■ 0255982 0001208 291 ■

Page 113

Pin Grid Array

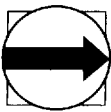

PGA Socket and Adapter Footprints

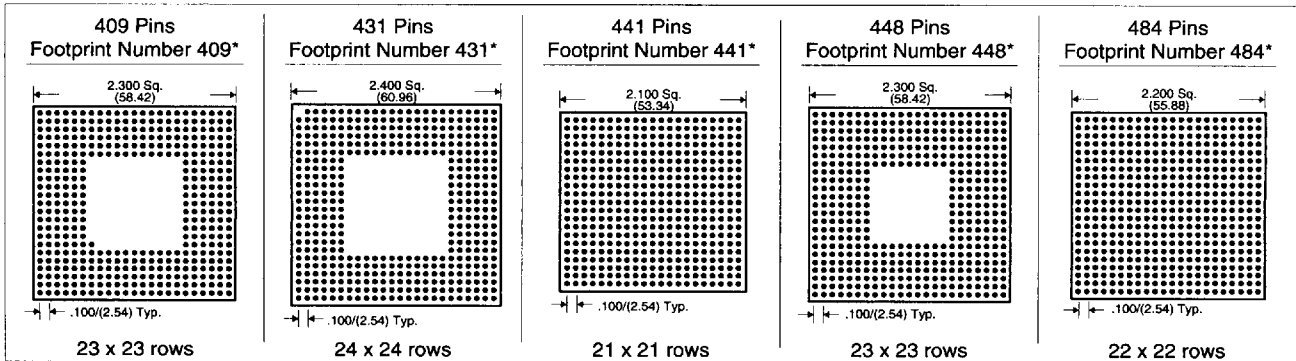

* Not Currently Available in Molded Body.

For Ordering Information See Page 78 - 88. For cutout window consult factory.