

1N5400 THRU 1N5408

List

List.....	1
Package outline.....	2
Features.....	2
Mechanical data.....	2
Maximum ratings	2
Rating and characteristic curves.....	3
Pinning information.....	4
Marking.....	4
Taping & bulk specifications for AXIAL devices.....	4
Suggested thermal profiles for soldering processes.....	5
High reliability test capabilities.....	6

1N5400 THRU 1N5408

3.0A Axial Leaded General Purpose Rectifiers - 50V-1000V

Features

- Axial lead type devices for through hole design.
- High current capability.
- High surge capability.
- Silicon rubber coating chip junction.
- Lead-free parts meet environmental standards of MIL-STD-19500 /228
- Suffix "-H" indicates Halogen-free parts, ex. 1N5400-H.

Mechanical data

- Epoxy : UL94-V0 rated flame retardant
- Case : Molded plastic, DO-201AD
- Lead : Axial leads, solderable per MIL-STD-202, Method 208 guranteed
- Polarity: Color band denotes cathode end
- Mounting Position : Any
- Weight : Approximated 1.10 gram

Package outline

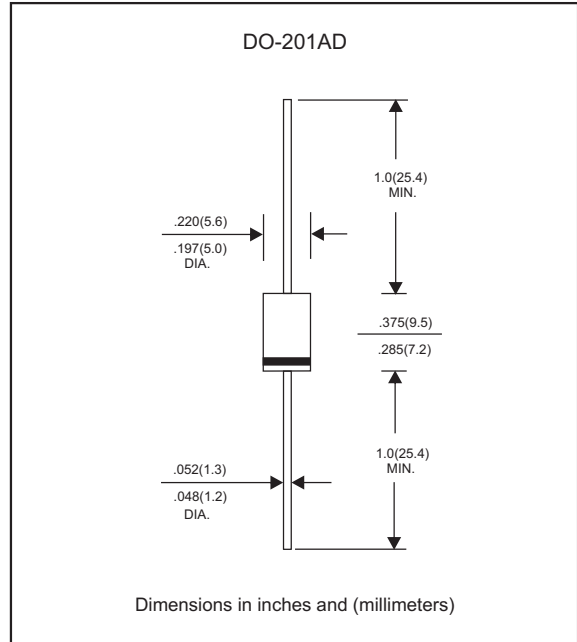

Maximum ratings and Electrical Characteristics (AT $T_A=25^{\circ}\text{C}$ unless otherwise noted)

PARAMETER	CONDITIONS	Symbol	MIN.	TYP.	MAX.	UNIT
Forward rectified current	See Fig.2	I_o			3.0	A
Forward surge current	8.3ms single half sine-wave (JEDEC methode)	I_{FSM}			200	A
Reverse current	$V_R = V_{RRM} \quad T_J = 25^{\circ}\text{C}$	I_R			5.0	μA
	$V_R = V_{RRM} \quad T_J = 100^{\circ}\text{C}$				50	
Thermal resistance	Junction to ambient	$R_{\theta JA}$		30		$^{\circ}\text{C}/\text{W}$
Diode junction capacitance	f=1MHz and applied 4V DC reverse voltage	C_J		40		pF
Storage temperature		T_{STG}	-65		+175	$^{\circ}\text{C}$

SYMBOLS	V_{RRM}^{*1} (V)	V_{RMS}^{*2} (V)	V_R^{*3} (V)	V_F^{*4} (V)	Operating temperature $T_J, (^{\circ}\text{C})$
1N5400	50	35	50	1.00	-55 to +125
1N5401	100	70	100		
1N5402	200	140	200		
1N5404	400	280	400		
1N5406	600	420	600		
1N5407	800	560	800		
1N5408	1000	700	1000		

*1 Repetitive peak reverse voltage

*2 RMS voltage

*3 Continuous reverse voltage

*4 Maximum forward voltage@ $I_F=3.0\text{A}$

Rating and characteristic curves (1N5400 THRU 1N5408)

FIG.1-TYPICAL FORWARD CHARACTERISTICS

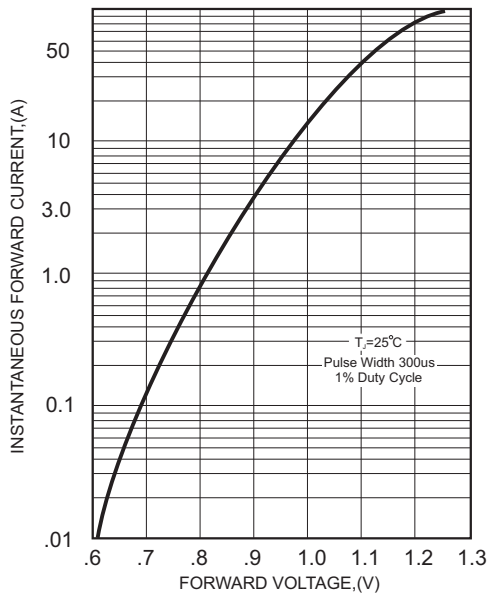

FIG.2-TYPICAL FORWARD CURRENT DERATING CURVE

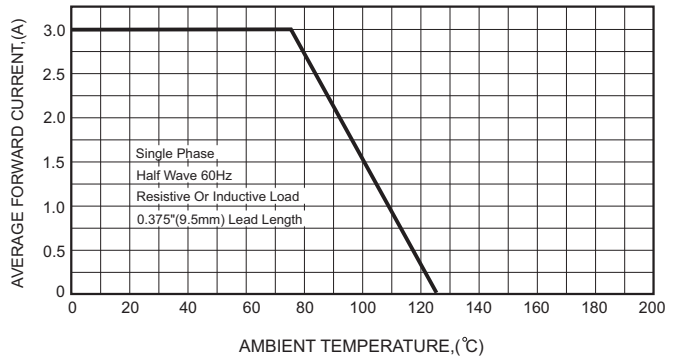

FIG.4-MAXIMUM NON-REPETITIVE FORWARD SURGE CURRENT

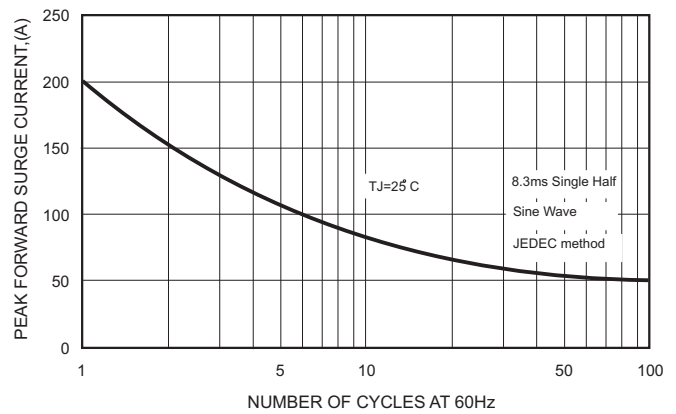

FIG.3 - TYPICAL REVERSE CHARACTERISTICS

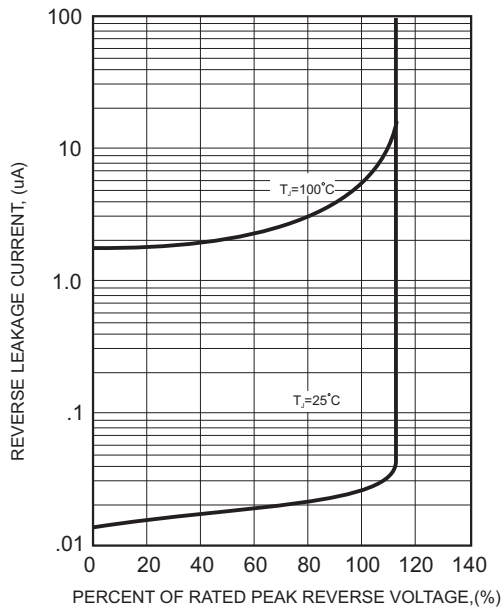
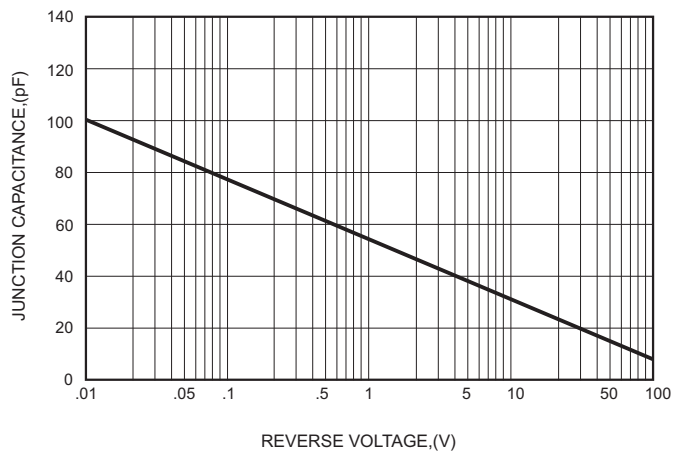



FIG.5-TYPICAL JUNCTION CAPACITANCE



1N5400 THRU 1N5408

Pinning information

Pin	Simplified outline	Symbol
Pin1 cathode Pin2 anode		

Marking

Type number	Marking code
1N5400	1N5400
1N5401	1N5401
1N5402	1N5402
1N5404	1N5404
1N5406	1N5406
1N5407	1N5407
1N5408	1N5408

Taping & bulk specifications for AXIAL devices

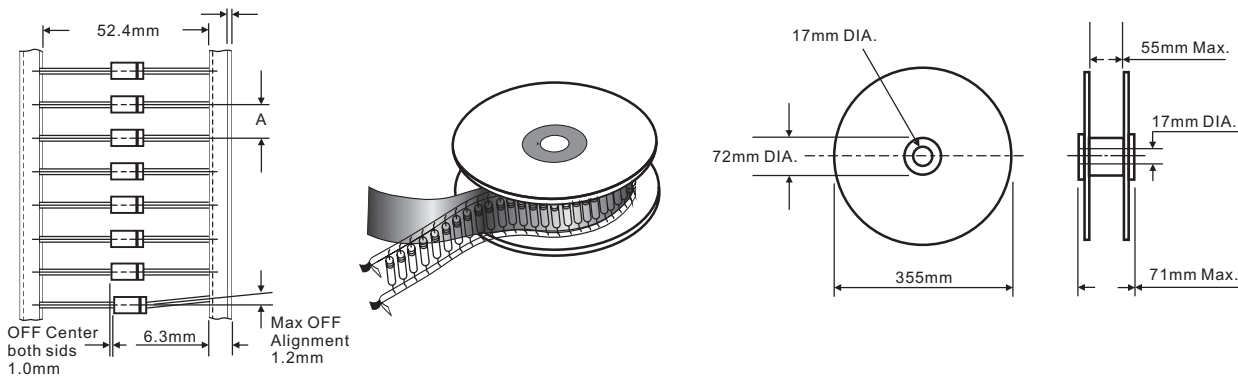

REEL PACKING

DEVICE CASE TYPE	Q'TY 1 (PCS / REEL)	COMPONENT SPACING "A" in FIG. A	CARTON SIZE (m/m)	Q'TY 2 (PCS / CARTON)	APPROX. CROSS WEIGHT(kg)
DO-201AD	1,200	10 mm	380 * 340 * 370	4,800	9.1

AMMO PACKING

DEVICE CASE TYPE	Q'TY 1 (PCS / BOX)	INNER BOX SIZE (m/m)	CARTON SIZE (m/m)	Q'TY 2 (PCS / CARTON)	APPROX. CROSS WEIGHT(kg)
DO-201AD	1,200	260 * 83 * 160	440 * 270 * 340	12,000	17.0

1N5400 THRU 1N5408

BULK PACKING

DEVICE CASE TYPE	Q'TY 1 (PCS / BOX)	INNER BOX SIZE (m/m)	CARTON SIZE (m/m)	Q'TY 2 (PCS / CARTON)	APPROX. CROSS WEIGHT(kg)
DO-201AD	500	305 * 73 * 40	347 * 320 * 271	12,000	16.4

Suggested thermal profiles for soldering processes

1. Lead free temperature profile wave-soldering

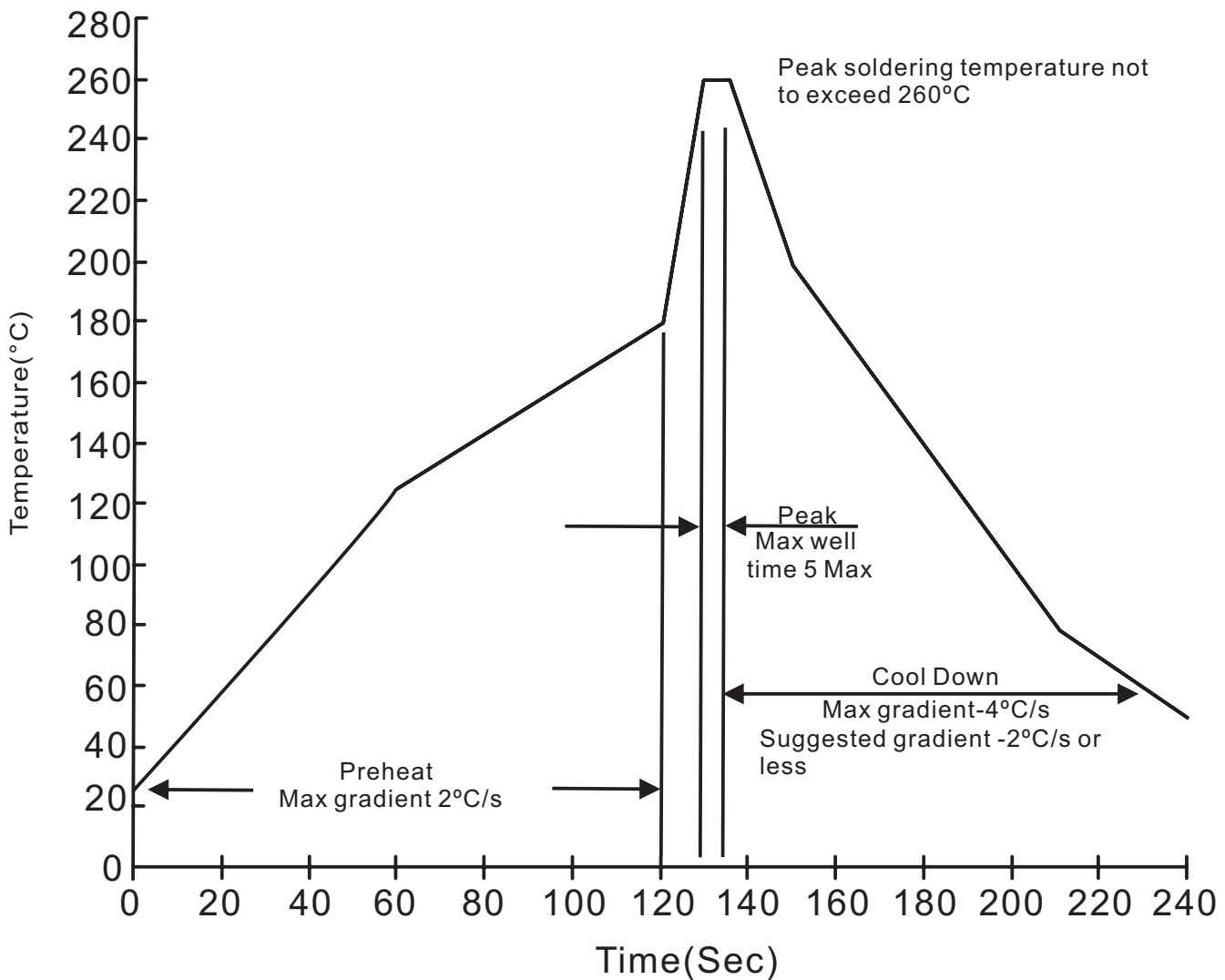

1N5400 THRU 1N5408**High reliability test capabilities**

Item Test	Conditions	Reference
1. Solder Resistance	at 260±5°C for 10±2sec. immerse body into solder 1/16"±1/32"	MIL-STD-750D METHOD-2031
2. Solderability	at 245±5°C for 5 sec.	MIL-STD-202F METHOD-208
3. Pull Test	2.0kg in axial lead direction for 10 sec. $I_F = I_O$	MIL-STD-202F METHOD-211A
4. Bend Lead	2.0kg weight applied to each lead bending arc 90°±5° for 3 times	MIL-STD-202F METHOD-211A
5. High Temperature Reverse Bias	$V_R = 80\%$ rate at $T_J = 125^\circ\text{C}$ for 168 hrs.	MIL-STD-750D METHOD-1038
6. Forward Operation Life	Rated average rectifier current at $T_A = 25^\circ\text{C}$ for 500hrs. $T_A = 25^\circ\text{C}$, $I_F = I_O$	MIL-STD-750D METHOD-1027
7. Intermittent Operation Life	On state: power on for 5 min. off state: power off for 5 min, on and off for 500 cycles.	MIL-STD-750D METHOD-1036
8. Pressure Cooker	15P _{sig} at $T_A = 121^\circ\text{C}$ for 4 hrs.	JESD22-A102
9. Temperature Cycling	-55°C to +125°C dwelled for 30 min. and transferred for 5min. total 10 cycles.	MIL-STD-750D METHOD-1051
10. Forward Surge	8.3ms single half sine-wave one surge.	MIL-STD-750D METHOD-4066-2
11. Humidity	at $T_A = 85^\circ\text{C}$, RH=85% for 1000hrs.	MIL-STD-750D METHOD-1021
12. High Temperature Storage Life	at 175°C for 1000 hrs.	MIL-STD-750D METHOD-1031