

## TIP105/106/107

### Monolithic Construction With Built In Base-Emitter Shunt Resistors

- High DC Current Gain :  $h_{FE}=1000$  @  $V_{CE}=-4V$ ,  $I_C = -3A$  (Min.)
- Collector-Emitter Sustaining Voltage
- Low Collector-Emitter Saturation Voltage
- Industrial Use
- Complementary to TIP100/101/102

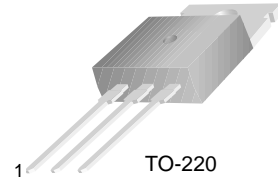

TO-220  
1.Base 2.Collector 3.Emmitter

### PNP Epitaxial Silicon Darlington Transistor

#### Absolute Maximum Ratings $T_C=25^\circ\text{C}$ unless otherwise noted

Symbol	Parameter	Value	Units	
$V_{CBO}$	Collector-Base Voltage	: TIP105	- 60	V
		: TIP106	- 80	V
		: TIP107	- 100	V
$V_{CEO}$	Collector-Emitter Voltage	: TIP105	- 60	V
		: TIP106	- 80	V
		: TIP107	- 100	V
$V_{EBO}$	Emitter-Base Voltage	- 5	V	
$I_C$	Collector Current (DC)	- 8	A	
$I_{CP}$	Collector Current (Pulse)	- 15	A	
$I_B$	Base Current (DC)	- 1	A	
$P_C$	Collector Dissipation ( $T_a=25^\circ\text{C}$ )	2	W	
	Collector Dissipation ( $T_C=25^\circ\text{C}$ )	80	W	
$T_J$	Junction Temperature	150	$^\circ\text{C}$	
$T_{STG}$	Storage Temperature	- 65 ~ 150	$^\circ\text{C}$	

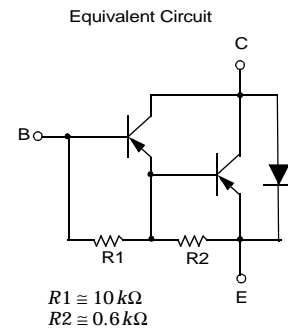

#### Electrical Characteristics $T_C=25^\circ\text{C}$ unless otherwise noted

Symbol	Parameter	Test Condition	Min.	Max.	Units
$V_{CEO(sus)}$	Collector-Emitter Sustaining Voltage	$I_C = -30\text{mA}$ , $I_B = 0$	: TIP105	-60	V
			: TIP106	-80	V
			: TIP107	-100	V
$I_{CEO}$	Collector Cut-off Current	$V_{CE} = -30\text{V}$ , $I_B = 0$ $V_{CE} = -40\text{V}$ , $I_B = 0$ $V_{CE} = -50\text{V}$ , $I_B = 0$		-50	$\mu\text{A}$
				-50	$\mu\text{A}$
				-50	$\mu\text{A}$
$I_{CBO}$	Collector Cut-off Current	$V_{CB} = -60\text{V}$ , $I_E = 0$ $V_{CB} = -80\text{V}$ , $I_E = 0$ $V_{CB} = -100\text{V}$ , $I_E = 0$		-50	$\mu\text{A}$
				-50	$\mu\text{A}$
				-50	$\mu\text{A}$
$I_{EBO}$	Emitter Cut-off Current	$V_{BE} = -5\text{V}$ , $I_C = 0$		-2	mA
$h_{FE}$	DC Current Gain	$V_{CE} = -4\text{V}$ , $I_C = -3\text{A}$ $V_{CE} = -4\text{V}$ , $I_C = -8\text{A}$	1000 200	20000	
$V_{CE(sat)}$	Collector-Emitter Saturation Voltage	$I_C = -3\text{A}$ , $I_B = -6\text{mA}$ $I_C = -8\text{A}$ , $I_B = -80\text{mA}$		-2	V
				-2.5	V
$V_{BE(on)}$	Base-Emitter ON Voltage	$V_{CE} = -4\text{V}$ , $I_C = -8\text{A}$		-2.8	V
$C_{ob}$	Output Capacitance	$V_{CB} = -10\text{V}$ , $I_E = 0$ , $f = 0.1\text{MHz}$		300	pF

# Typical Characteristics

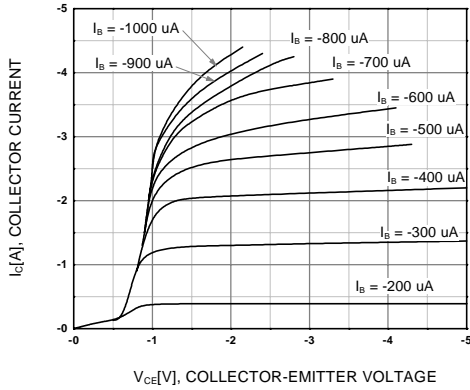

Figure 1. Static Characteristic

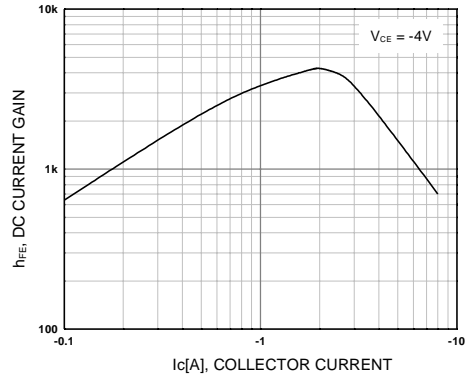

Figure 2. DC current Gain

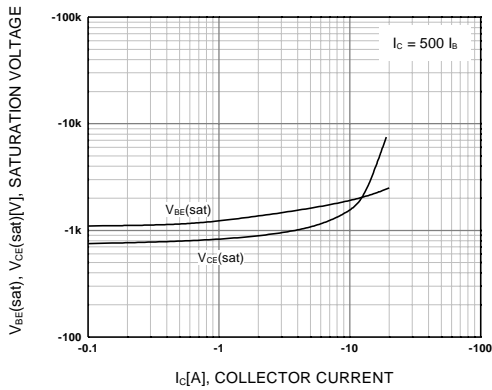

Figure 3. Collector-Emitter Saturation Voltage Base-Emitter Saturation Voltage

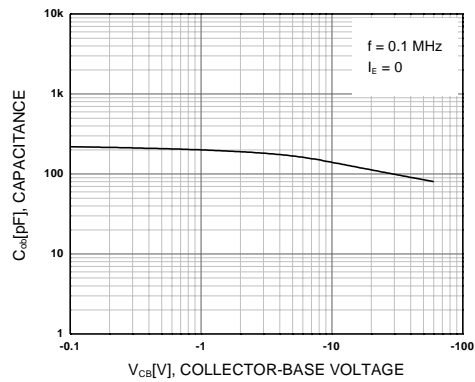

Figure 4. Collector Output Capacitance

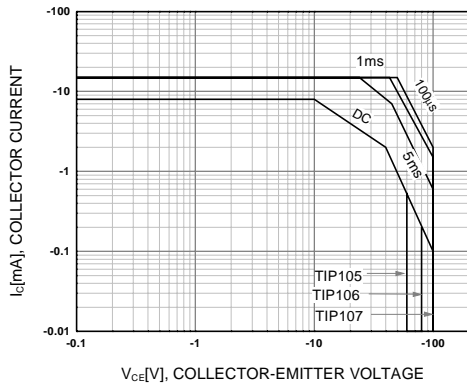

Figure 5. Safe Operating Area

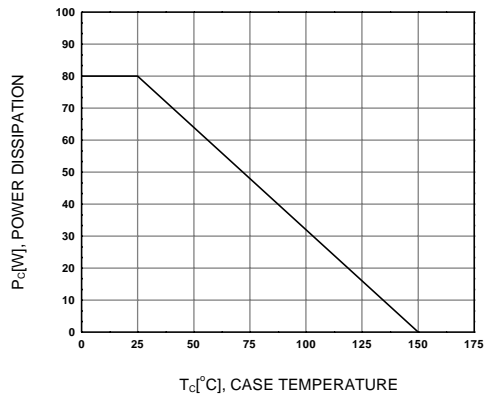
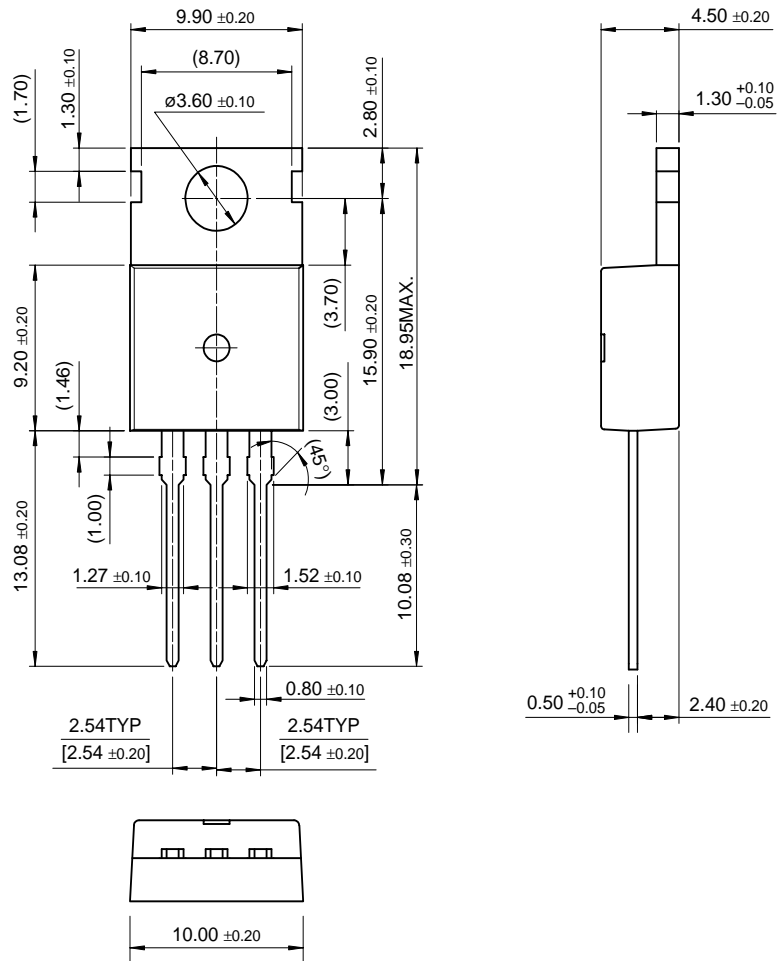

Figure 6. Power Derating

# Package Dimensions

## TO-220

TIP105/106/107



Dimensions in Millimeters

## TRADEMARKS

The following are registered and unregistered trademarks Fairchild Semiconductor owns or is authorized to use and is not intended to be an exhaustive list of all such trademarks.

ACEx™	FAST®	OPTOPLANAR™	STAR*POWER™
Bottomless™	FASTr™	PACMAN™	Stealth™
CoolFET™	FRFET™	POP™	SuperSOT™-3
CROSSVOLT™	GlobalOptoisolator™	Power247™	SuperSOT™-6
DenseTrench™	GTO™	PowerTrench®	SuperSOT™-8
DOMET™	HiSeC™	QFET™	SyncFET™
EcoSPARK™	ISOPLANAR™	QS™	TruTranslation™
E <sup>2</sup> CMOS™	LittleFET™	QT Optoelectronics™	TinyLogic™
EnSigna™	MicroFET™	Quiet Series™	UHC™
FACT™	MICROWIRE™	SLIENT SWITCHER®	UltraFET®
FACT Quiet Series™	OPTOLOGIC™	SMART START™	VCX™

STAR\*POWER is used under license

## DISCLAIMER

FAIRCHILD SEMICONDUCTOR RESERVES THE RIGHT TO MAKE CHANGES WITHOUT FURTHER NOTICE TO ANY PRODUCTS HEREIN TO IMPROVE RELIABILITY, FUNCTION OR DESIGN. FAIRCHILD DOES NOT ASSUME ANY LIABILITY ARISING OUT OF THE APPLICATION OR USE OF ANY PRODUCT OR CIRCUIT DESCRIBED HEREIN; NEITHER DOES IT CONVEY ANY LICENSE UNDER ITS PATENT RIGHTS, NOR THE RIGHTS OF OTHERS.

## LIFE SUPPORT POLICY

FAIRCHILD'S PRODUCTS ARE NOT AUTHORIZED FOR USE AS CRITICAL COMPONENTS IN LIFE SUPPORT DEVICES OR SYSTEMS WITHOUT THE EXPRESS WRITTEN APPROVAL OF FAIRCHILD SEMICONDUCTOR CORPORATION.

As used herein:

- Life support devices or systems are devices or systems which, (a) are intended for surgical implant into the body, or (b) support or sustain life, or (c) whose failure to perform when properly used in accordance with instructions for use provided in the labeling, can be reasonably expected to result in significant injury to the user.
- A critical component is any component of a life support device or system whose failure to perform can be reasonably expected to cause the failure of the life support device or system, or to affect its safety or effectiveness.

## PRODUCT STATUS DEFINITIONS

### Definition of Terms

Datasheet Identification	Product Status	Definition
Advance Information	Formative or In Design	This datasheet contains the design specifications for product development. Specifications may change in any manner without notice.
Preliminary	First Production	This datasheet contains preliminary data, and supplementary data will be published at a later date. Fairchild Semiconductor reserves the right to make changes at any time without notice in order to improve design.
No Identification Needed	Full Production	This datasheet contains final specifications. Fairchild Semiconductor reserves the right to make changes at any time without notice in order to improve design.
Obsolete	Not In Production	This datasheet contains specifications on a product that has been discontinued by Fairchild semiconductor. The datasheet is printed for reference information only.

Fairchild Semiconductor

SEARCH | [Parametric](#) | [Cross Reference](#)

space

Product Folders and

Applies

find products

[Home](#) >> [Find products](#) >>

[Products groups](#)

[Analog and Mixed](#)

[Signal](#)

[Discrete](#)

[Interface](#)

[Logic](#)

[Microcontrollers](#)

[Non-Volatile](#)

[Memory](#)

[Optoelectronics](#)

[Markets and](#)

[applications](#)

[New products](#)

[Product selection and](#)

[parametric search](#)

[Cross-reference](#)

[search](#)

technical information

buy products

technical support

my Fairchild

company

TIP107  
PNP Epitaxial Silicon Darlington Transistor

Contents

[Features](#) | [Product status/pricing/package](#)

Features

**Monolithic Construction with Built In Base-Emitter Shunt Resistors**

- High DC Current Gain:  $h_{FE}=1000$  @  $V_{CE}=-4V$ ,  $I_C=-3A$  (Min.)
- Collector-Emitter Sustaining Voltage
- Low Collector-Emitter Saturation Voltage
- Industrial Use
- Complementary to TIP100/101/102

[back to top](#)

[Product status/pricing/package](#)

Product	Product status	Pricing*	Package type	Leads	Packing method
TIP107TU	Full Production	\$0.50	TO-220	3	RAIL
TIP107	Full Production	\$0.50	TO-220	3	BULK

\* 1,000 piece Budgetary Pricing

[back to top](#)

[Home](#) | [Find products](#) | [Technical information](#) | [Buy products](#) | [Support](#) | [Company](#) | [Contact us](#) | [Site index](#) | [Privacy policy](#)

© Copyright 2002 Fairchild Semiconductor

Related Links

[Request samples](#)

[How to order products](#)

[Product Change Notices \(PCNs\)](#)

[Support](#)

[Distributor and field sales representatives](#)

[Quality and reliability](#)

[Design tools](#)

Datasheet

[Download this datasheet](#)

PDF

[e-mail this datasheet](#)

[E-]

This page [Print version](#)

Fairchild Semiconductor

SEARCH | [Parametric](#) | [Cross Reference](#)

space

Product Folders and

Applies

find products

[Home](#) >> [Find products](#) >>

[Products groups](#)

[Analog and Mixed](#)

[Signal](#)

[Discrete](#)

[Interface](#)

[Logic](#)

[Microcontrollers](#)

[Non-Volatile](#)

[Memory](#)

[Optoelectronics](#)

[Markets and](#)

[applications](#)

[New products](#)

[Product selection and](#)

[parametric search](#)

[Cross-reference](#)

[search](#)

technical information

buy products

technical support

my Fairchild

company

TIP106

PNP Epitaxial Silicon Darlington Transistor

Contents

[Features](#) | [Product status/pricing/package](#)

Features

**Monolithic Construction with Built In Base-Emitter Shunt Resistors**

- High DC Current Gain:  $h_{FE}=1000$  @  $V_{CE}=-4V$ ,  $I_C=-3A$  (Min.)
- Collector-Emitter Sustaining Voltage
- Low Collector-Emitter Saturation Voltage
- Industrial Use
- Complementary to TIP100/101/102

[back to top](#)

[Product status/pricing/package](#)

Product	Product status	Pricing*	Package type	Leads	Packing method
TIP106TU	Full Production	\$0.50	TO-220	3	RAIL
TIP106	Full Production	\$0.50	TO-220	3	BULK

\* 1,000 piece Budgetary Pricing

[back to top](#)

[Home](#) | [Find products](#) | [Technical information](#) | [Buy products](#) | [Support](#) | [Company](#) | [Contact us](#) | [Site index](#) | [Privacy policy](#)

© Copyright 2002 Fairchild Semiconductor

Related Links

[Request samples](#)

[How to order products](#)

[Product Change Notices \(PCNs\)](#)

[Support](#)

[Distributor and field sales representatives](#)

[Quality and reliability](#)

[Design tools](#)

Datasheet

[Download this datasheet](#)

PDF

[e-mail this datasheet](#)

[E-]

This page [Print version](#)

Fairchild Semiconductor

SEARCH | [Parametric](#) | [Cross Reference](#)

space

Product Folders and

Applies

find products

[Home](#) >> [Find products](#) >>

[Products groups](#)

[Analog and Mixed](#)

[Signal](#)

[Discrete](#)

[Interface](#)

[Logic](#)

[Microcontrollers](#)

[Non-Volatile](#)

[Memory](#)

[Optoelectronics](#)

[Markets and](#)

[applications](#)

[New products](#)

[Product selection and](#)

[parametric search](#)

[Cross-reference](#)

[search](#)

technical information

buy products

technical support

my Fairchild

company

TIP105  
PNP Epitaxial Silicon Darlington Transistor

Contents

[Features](#) | [Product status/pricing/package](#)

Features

**Monolithic Construction with Built In Base-Emitter Shunt Resistors**

- High DC Current Gain:  $h_{FE}=1000$  @  $V_{CE}=-4V$ ,  $I_C=-3A$  (Min.)
- Collector-Emitter Sustaining Voltage
- Low Collector-Emitter Saturation Voltage
- Industrial Use
- Complementary to TIP100/101/102

[back to top](#)

[Product status/pricing/package](#)

Product	Product status	Pricing*	Package type	Leads	Packing method
TIP105TU	Full Production	\$0.50	TO-220	3	RAIL
TIP105	Full Production	\$0.50	TO-220	3	BULK

\* 1,000 piece Budgetary Pricing

[back to top](#)

[Home](#) | [Find products](#) | [Technical information](#) | [Buy products](#) | [Support](#) | [Company](#) | [Contact us](#) | [Site index](#) | [Privacy policy](#)

© Copyright 2002 Fairchild Semiconductor

Related Links

[Request samples](#)

[How to order products](#)

[Product Change Notices \(PCNs\)](#)

[Support](#)

[Distributor and field sales representatives](#)

[Quality and reliability](#)

[Design tools](#)

Datasheet

[Download this datasheet](#)

PDF

[e-mail this datasheet](#)

[E-]

This page [Print version](#)