

High Current FET Driver

FEATURES

- Totem Pole Output with 6A Source/Sink Drive
- 3ns Delay
- 20ns Rise and Fall Time into 2.2nF
- 8ns Rise and Fall Time into 30nF
- 4.7V to 18V Operation
- Inverting and Non-Inverting Outputs
- Under-Voltage Lockout with Hysteresis
- Thermal Shutdown Protection
- MINIDIP and Power Packages

DESCRIPTION

The UC1710 family of FET drivers is made with a high-speed Schottky process to interface between low-level control functions and very high-power switching devices-particularly power MOSFET's. These devices accept low-current digital inputs to activate a high-current, totem pole output which can source or sink a minimum of 6A.

Supply voltages for both V_{IN} and V_C can independently range from 4.7V to 18V. These devices also feature under-voltage lockout with hysteresis.

The UC1710 is packaged in an 8-pin hermetically sealed dual in-line package for -55°C to $+125^{\circ}\text{C}$ operation. The UC2710 and UC3710 are specified for a temperature range of -40°C to $+85^{\circ}\text{C}$ and 0°C to $+70^{\circ}\text{C}$ respectively and are available in either an 8-pin plastic dual in-line or a 5-pin, TO-220 package. Surface mount devices are also available.

TRUTH TABLE

INV	N.I.	Out
H	H	L
L	H	H
H	L	L
L	L	L

$\overline{\text{OUT}} = \overline{\text{INV}}$ and $\overline{\text{N.I.}}$
 $\overline{\text{OUT}} = \text{INV}$ or $\overline{\text{N.I.}}$

ORDERING INFORMATION

	TEMPERATURE RANGE	PACKAGE
UC1710J	-55°C to $+125^{\circ}\text{C}$	8 pin CDIP
UC2710DW	-40°C to $+85^{\circ}\text{C}$	Not Available
UC2710J		Not Available
UC2710N		8 pin PDIP
UC2710T		5 pin TO220
UC3710DW	0°C to $+70^{\circ}\text{C}$	16 pin SOIC-wide
UC3710N		8 pin PDIP
UC3710T		5 pin TO220

BLOCK DIAGRAM

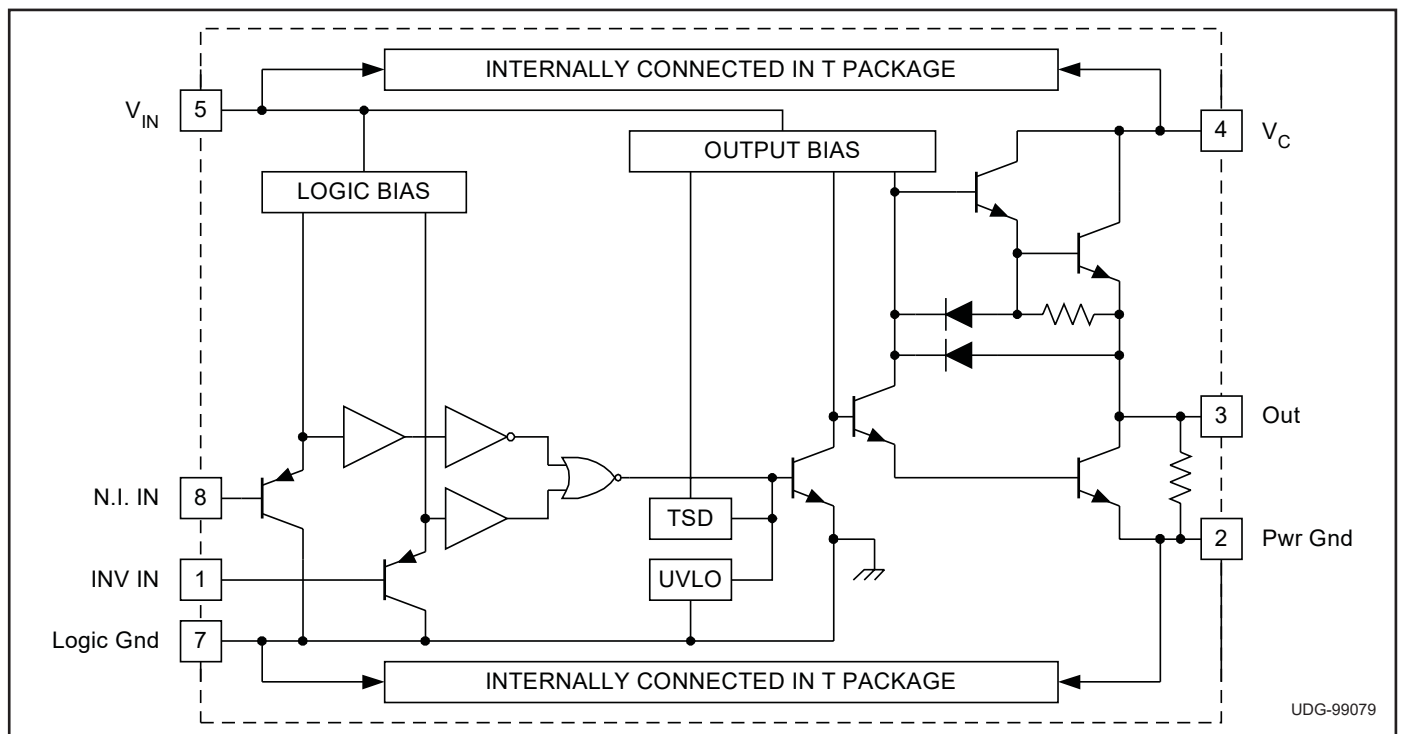

ABSOLUTE MAXIMUM RATINGS

	N-Package	J-Package	T-Package
Supply Voltage, V_{IN}	20V	20V	20V
Collector Supply Voltage, V_C	20V	20V	20V
Operating Voltage	18V	18V	18V
Output Current (Source or Sink)			
Steady-State	$\pm 500\text{mA}$	$\pm 500\text{mA}$	$\pm 1\text{A}$
Digital Inputs	$-0.3\text{V} - V_{IN}$	$-0.3\text{V} - V_{IN}$	$-0.3\text{V} - V_{IN}$
Power Dissipation at $T_a=25^\circ\text{C}$	1W	1W	3W
Power Dissipation at T (Case) = 25°C	2W	2W	25W
Operating Junction Temperature	-55°C to $+150^\circ\text{C}$	-55°C to $+150^\circ\text{C}$	-55°C to $+150^\circ\text{C}$
Storage Temperature	-65°C to $+150^\circ\text{C}$	-65°C to $+150^\circ\text{C}$	-65°C to $+150^\circ\text{C}$
Lead Temperature (Soldering, 10 seconds)	300°C	300°C	300°C

Note 1: All currents are positive into, negative out of the specified terminal.

Note 2: Consult Unitorde Integrated Circuits databook for information regarding thermal specifications and limitations of packages.

CONNECTION DIAGRAMS

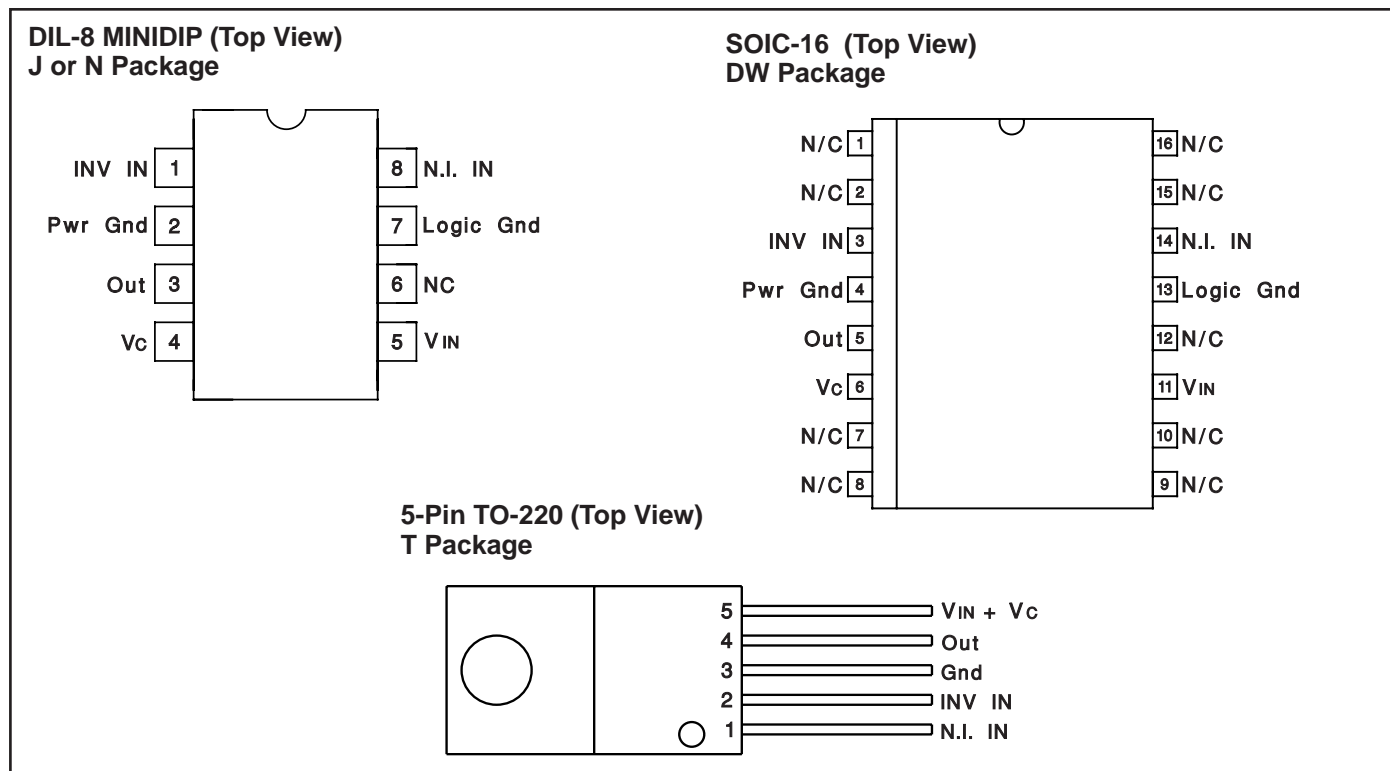

ELECTRICAL CHARACTERISTICS: Unless otherwise stated, these specifications apply for $V_{IN} = V_C = 15\text{V}$, No load, $T_A = T_J$.

PARAMETERS	TEST CONDITIONS	MIN	TYP	MAX	UNITS
V_{IN} Supply Current	$V_{IN} = 18\text{V}$, $V_C = 18\text{V}$, Output Low		26	35	mA
	$V_{IN} = 18\text{V}$, $V_C = 18\text{V}$, Output High		21	30	mA
V_C Supply Current	$V_{IN} = 18\text{V}$, $V_C = 18\text{V}$, Output Low		1.5	5.0	mA
	$V_{IN} = 18\text{V}$, $V_C = 18\text{V}$, Output High		5.0	8	mA
UVLO Threshold	V_{IN} High to Low	3.8	4.1	4.4	V
	V_{IN} Low to High	4.1	4.4	4.8	V

ELECTRICAL CHARACTERISTICS: Unless otherwise stated, these specifications apply for $V_{IN} = V_C = 15V$, No load, $T_A = T_J$.

PARAMETERS	TEST CONDITIONS	MIN	TYP	MAX	UNITS
UVLO Threshold Hysteresis		0.1	0.3	0.5	V
Digital Input Low Level				0.8	V
Digital Input High Level		2.0			V
Digital Input Current	Digital Input = 0.0V	-70	-4.0		μA
Output High Sat., $V_C - V_O$	$I_O = -100mA$		1.35	2.2	V
	$I_O = -6A$		3.2	4.5	V
Output Low Sat., V_O	$I_O = 100mA$		0.25	0.6	V
	$I_O = 6A$		3.4	4.5	V
Thermal Shutdown			165		$^{\circ}C$
From Inv., Input to Output (Note 3, 4):					
Rise Time Delay	CL = 0		35	70	ns
	CL = 2.2nF		35	70	ns
	CL = 30nF		35	70	ns
10% to 90% Rise	CL = 0		20	40	ns
	CL = 2.2nF		25	40	ns
	CL = 30nF		85	150	ns
Fall Time Delay	CL = 0		35	70	ns
	CL = 2.2nF		35	70	ns
	CL = 30nF		35	80	ns
90% to 10% Fall	CL = 0		15	40	ns
	CL = 2.2nF		20	40	ns
	CL = 30nF		85	150	ns
From N.I. Input to Output (Note 3,4):					
Rise Time Delay	CL = 0		35	70	ns
	CL = 2.2nF		35	70	ns
	CL = 30nF		35	70	ns
10% to 90% Rise	CL = 0		20	40	ns
	CL = 2.2nF		25	40	ns
	CL = 30nF		85	150	ns
Fall Time Delay	CL = 0		35	70	ns
	CL = 2.2nF		35	70	ns
	CL = 30nF		35	80	ns
90% to 10% Fall	CL = 0		15	40	ns
	CL = 2.2nF		20	50	ns
	CL = 30nF		85	150	ns
Total Supply Current at 200kHz Input Switching Frequency	$T_A = 25^{\circ}C$ (Note 5) CL = 0		30	40	mA

Note: 3. Delay measured from 50% input change to 10% output change.

Note: 4. Those parameters with CL = 30nF are not tested in production.

Note: 5. Inv. Input pulsed at 50% duty cycle with N.I. Input = 3V. or N.I. Input pulsed at 50% duty cycle with Inv. Input = 0V.

PACKAGING INFORMATION

Orderable Device	Status (1)	Package Type	Package Drawing	Pins	Package Qty	Eco Plan (2)	Lead/Ball Finish (6)	MSL Peak Temp (3)	Op Temp (°C)	Device Marking (4/5)	Samples
5962-0152001QPA	ACTIVE	CDIP	JG	8	1	TBD	A42	N / A for Pkg Type	-55 to 125	0152001QPA UC1710	Samples
5962-0152001VPA	ACTIVE	CDIP	JG	8	1	TBD	A42	N / A for Pkg Type	-55 to 125	0152001VPA UC1710	Samples
UC1710J	ACTIVE	CDIP	JG	8	1	TBD	A42	N / A for Pkg Type	-55 to 125	UC1710J	Samples
UC1710J883B	ACTIVE	CDIP	JG	8	1	TBD	A42	N / A for Pkg Type	-55 to 125	0152001QPA UC1710	Samples
UC2710N	ACTIVE	PDIP	P	8	50	Green (RoHS & no Sb/Br)	CU NIPDAU	N / A for Pkg Type	-40 to 85	UC2710N	Samples
UC2710NG4	ACTIVE	PDIP	P	8	50	Green (RoHS & no Sb/Br)	CU NIPDAU	N / A for Pkg Type	-40 to 85	UC2710N	Samples
UC2710T	ACTIVE	TO-220	KC	5	50	Green (RoHS & no Sb/Br)	CU SN	N / A for Pkg Type	-40 to 85	UC2710T	Samples
UC2710TG3	ACTIVE	TO-220	KC	5	50	Green (RoHS & no Sb/Br)	CU SN	N / A for Pkg Type	-40 to 85	UC2710T	Samples
UC3710DW	ACTIVE	SOIC	DW	16	40	Green (RoHS & no Sb/Br)	CU NIPDAU	Level-2-260C-1 YEAR	0 to 70	UC3710DW	Samples
UC3710DWG4	ACTIVE	SOIC	DW	16	40	Green (RoHS & no Sb/Br)	CU NIPDAU	Level-2-260C-1 YEAR	0 to 70	UC3710DW	Samples
UC3710N	ACTIVE	PDIP	P	8	50	Green (RoHS & no Sb/Br)	CU NIPDAU Call TI	N / A for Pkg Type	0 to 70	UC3710N	Samples
UC3710NG4	ACTIVE	PDIP	P	8	50	Green (RoHS & no Sb/Br)	Call TI	N / A for Pkg Type	0 to 70	UC3710N	Samples
UC3710T	ACTIVE	TO-220	KC	5	50	Green (RoHS & no Sb/Br)	CU SN	N / A for Pkg Type	0 to 70	UC3710T	Samples
UC3710TG3	ACTIVE	TO-220	KC	5	50	Green (RoHS & no Sb/Br)	CU SN	N / A for Pkg Type	0 to 70	UC3710T	Samples

(1) The marketing status values are defined as follows:

ACTIVE: Product device recommended for new designs.

LIFEBUY: TI has announced that the device will be discontinued, and a lifetime-buy period is in effect.

NRND: Not recommended for new designs. Device is in production to support existing customers, but TI does not recommend using this part in a new design.

PREVIEW: Device has been announced but is not in production. Samples may or may not be available.

OBSOLETE: TI has discontinued the production of the device.

(2) **RoHS:** TI defines "RoHS" to mean semiconductor products that are compliant with the current EU RoHS requirements for all 10 RoHS substances, including the requirement that RoHS substance do not exceed 0.1% by weight in homogeneous materials. Where designed to be soldered at high temperatures, "RoHS" products are suitable for use in specified lead-free processes. TI may reference these types of products as "Pb-Free".

RoHS Exempt: TI defines "RoHS Exempt" to mean products that contain lead but are compliant with EU RoHS pursuant to a specific EU RoHS exemption.

Green: TI defines "Green" to mean the content of Chlorine (Cl) and Bromine (Br) based flame retardants meet JS709B low halogen requirements of ≤ 1000 ppm threshold. Antimony trioxide based flame retardants must also meet the ≤ 1000 ppm threshold requirement.

(3) **MSL, Peak Temp.** - The Moisture Sensitivity Level rating according to the JEDEC industry standard classifications, and peak solder temperature.

(4) There may be additional marking, which relates to the logo, the lot trace code information, or the environmental category on the device.

(5) Multiple Device Markings will be inside parentheses. Only one Device Marking contained in parentheses and separated by a "~" will appear on a device. If a line is indented then it is a continuation of the previous line and the two combined represent the entire Device Marking for that device.

(6) **Lead/Ball Finish** - Orderable Devices may have multiple material finish options. Finish options are separated by a vertical ruled line. Lead/Ball Finish values may wrap to two lines if the finish value exceeds the maximum column width.

Important Information and Disclaimer: The information provided on this page represents TI's knowledge and belief as of the date that it is provided. TI bases its knowledge and belief on information provided by third parties, and makes no representation or warranty as to the accuracy of such information. Efforts are underway to better integrate information from third parties. TI has taken and continues to take reasonable steps to provide representative and accurate information but may not have conducted destructive testing or chemical analysis on incoming materials and chemicals. TI and TI suppliers consider certain information to be proprietary, and thus CAS numbers and other limited information may not be available for release.

In no event shall TI's liability arising out of such information exceed the total purchase price of the TI part(s) at issue in this document sold by TI to Customer on an annual basis.

OTHER QUALIFIED VERSIONS OF UC1710, UC1710-SP, UC3710 :

- Catalog: [UC3710](#), [UC1710](#)
- Military: [UC1710](#)
- Space: [UC1710-SP](#)

NOTE: Qualified Version Definitions:

- Catalog - TI's standard catalog product
- Military - QML certified for Military and Defense Applications

- Space - Radiation tolerant, ceramic packaging and qualified for use in Space-based application

PACKAGING INFORMATION

Orderable Device	Status (1)	Package Type	Package Drawing	Pins	Package Qty	Eco Plan (2)	Lead finish/ Ball material (6)	MSL Peak Temp (3)	Op Temp (°C)	Device Marking (4/5)	Samples
5962-0152001QPA	ACTIVE	CDIP	JG	8	50	Non-RoHS & Green	SNPB	N / A for Pkg Type	-55 to 125	0152001QPA UC1710	Samples
5962-0152001VPA	ACTIVE	CDIP	JG	8	50	Non-RoHS & Green	SNPB	N / A for Pkg Type	-55 to 125	0152001VPA UC1710	Samples
UC1710J	ACTIVE	CDIP	JG	8	50	Non-RoHS & Green	SNPB	N / A for Pkg Type	-55 to 125	UC1710J	Samples
UC1710J883B	ACTIVE	CDIP	JG	8	50	Non-RoHS & Green	SNPB	N / A for Pkg Type	-55 to 125	0152001QPA UC1710	Samples
UC2710N	ACTIVE	PDIP	P	8	50	RoHS & Green	NIPDAU	N / A for Pkg Type	-40 to 85	UC2710N	Samples
UC3710DW	LIFEBUY	SOIC	DW	16	40	RoHS & Green	NIPDAU	Level-2-260C-1 YEAR	0 to 70	UC3710DW	
UC3710DWG4	LIFEBUY	SOIC	DW	16	40	RoHS & Green	NIPDAU	Level-2-260C-1 YEAR	0 to 70	UC3710DW	
UC3710N	ACTIVE	PDIP	P	8	50	RoHS & Green	NIPDAU	N / A for Pkg Type	0 to 70	UC3710N	Samples
UC3710NG4	ACTIVE	PDIP	P	8	50	RoHS & Green	NIPDAU	N / A for Pkg Type	0 to 70	UC3710N	Samples
UC3710T	ACTIVE	TO-220	KC	5	50	RoHS & Green	SN	N / A for Pkg Type	0 to 70	UC3710T	Samples
UC3710TG3	ACTIVE	TO-220	KC	5	50	RoHS & Green	SN	N / A for Pkg Type	0 to 70	UC3710T	Samples

(1) The marketing status values are defined as follows:

ACTIVE: Product device recommended for new designs.

LIFEBUY: TI has announced that the device will be discontinued, and a lifetime-buy period is in effect.

NRND: Not recommended for new designs. Device is in production to support existing customers, but TI does not recommend using this part in a new design.

PREVIEW: Device has been announced but is not in production. Samples may or may not be available.

OBSOLETE: TI has discontinued the production of the device.

(2) **RoHS:** TI defines "RoHS" to mean semiconductor products that are compliant with the current EU RoHS requirements for all 10 RoHS substances, including the requirement that RoHS substance do not exceed 0.1% by weight in homogeneous materials. Where designed to be soldered at high temperatures, "RoHS" products are suitable for use in specified lead-free processes. TI may reference these types of products as "Pb-Free".

RoHS Exempt: TI defines "RoHS Exempt" to mean products that contain lead but are compliant with EU RoHS pursuant to a specific EU RoHS exemption.

Green: TI defines "Green" to mean the content of Chlorine (Cl) and Bromine (Br) based flame retardants meet JS709B low halogen requirements of <=1000ppm threshold. Antimony trioxide based flame retardants must also meet the <=1000ppm threshold requirement.

(3) MSL, Peak Temp. - The Moisture Sensitivity Level rating according to the JEDEC industry standard classifications, and peak solder temperature.

(4) There may be additional marking, which relates to the logo, the lot trace code information, or the environmental category on the device.

(5) Multiple Device Markings will be inside parentheses. Only one Device Marking contained in parentheses and separated by a "~" will appear on a device. If a line is indented then it is a continuation of the previous line and the two combined represent the entire Device Marking for that device.

(6) Lead finish/Ball material - Orderable Devices may have multiple material finish options. Finish options are separated by a vertical ruled line. Lead finish/Ball material values may wrap to two lines if the finish value exceeds the maximum column width.

Important Information and Disclaimer:The information provided on this page represents TI's knowledge and belief as of the date that it is provided. TI bases its knowledge and belief on information provided by third parties, and makes no representation or warranty as to the accuracy of such information. Efforts are underway to better integrate information from third parties. TI has taken and continues to take reasonable steps to provide representative and accurate information but may not have conducted destructive testing or chemical analysis on incoming materials and chemicals. TI and TI suppliers consider certain information to be proprietary, and thus CAS numbers and other limited information may not be available for release.

In no event shall TI's liability arising out of such information exceed the total purchase price of the TI part(s) at issue in this document sold by TI to Customer on an annual basis.

OTHER QUALIFIED VERSIONS OF UC1710, UC1710-SP, UC3710 :

- Catalog : [UC3710](#), [UC1710](#)
- Military : [UC1710](#)
- Space : [UC1710-SP](#)

NOTE: Qualified Version Definitions:

- Catalog - TI's standard catalog product
- Military - QML certified for Military and Defense Applications
- Space - Radiation tolerant, ceramic packaging and qualified for use in Space-based application

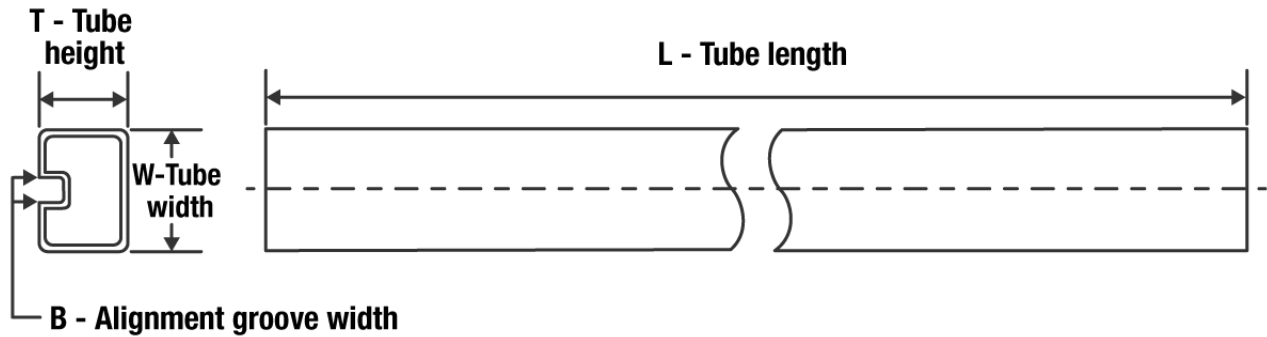
TUBE

*All dimensions are nominal

Device	Package Name	Package Type	Pins	SPQ	L (mm)	W (mm)	T (μm)	B (mm)
UC2710N	P	PDIP	8	50	506	13.97	11230	4.32
UC3710DW	DW	SOIC	16	40	507	12.83	5080	6.6
UC3710DWG4	DW	SOIC	16	40	507	12.83	5080	6.6
UC3710N	P	PDIP	8	50	506	13.97	11230	4.32
UC3710NG4	P	PDIP	8	50	506	13.97	11230	4.32
UC3710T	KC	TO-220	5	50	546	31	11930	3.17
UC3710TG3	KC	TO-220	5	50	546	31	11930	3.17

IMPORTANT NOTICE AND DISCLAIMER

TI PROVIDES TECHNICAL AND RELIABILITY DATA (INCLUDING DATA SHEETS), DESIGN RESOURCES (INCLUDING REFERENCE DESIGNS), APPLICATION OR OTHER DESIGN ADVICE, WEB TOOLS, SAFETY INFORMATION, AND OTHER RESOURCES "AS IS" AND WITH ALL FAULTS, AND DISCLAIMS ALL WARRANTIES, EXPRESS AND IMPLIED, INCLUDING WITHOUT LIMITATION ANY IMPLIED WARRANTIES OF MERCHANTABILITY, FITNESS FOR A PARTICULAR PURPOSE OR NON-INFRINGEMENT OF THIRD PARTY INTELLECTUAL PROPERTY RIGHTS.

These resources are intended for skilled developers designing with TI products. You are solely responsible for (1) selecting the appropriate TI products for your application, (2) designing, validating and testing your application, and (3) ensuring your application meets applicable standards, and any other safety, security, regulatory or other requirements.

These resources are subject to change without notice. TI grants you permission to use these resources only for development of an application that uses the TI products described in the resource. Other reproduction and display of these resources is prohibited. No license is granted to any other TI intellectual property right or to any third party intellectual property right. TI disclaims responsibility for, and you will fully indemnify TI and its representatives against, any claims, damages, costs, losses, and liabilities arising out of your use of these resources.

TI's products are provided subject to [TI's Terms of Sale](#) or other applicable terms available either on [ti.com](https://www.ti.com) or provided in conjunction with such TI products. TI's provision of these resources does not expand or otherwise alter TI's applicable warranties or warranty disclaimers for TI products.

TI objects to and rejects any additional or different terms you may have proposed.

Mailing Address: Texas Instruments, Post Office Box 655303, Dallas, Texas 75265
Copyright © 2023, Texas Instruments Incorporated