

500mW 1N52 Series Zener Diodes

1N52 Series

- . 500mW DO-35
- . Zener voltage regulator diodes
- . Hermetically sealed glass silicon zener diodes
- . Complete voltage range_2.4 to 43 volts
- . We declare that the material of product compliance with RoHS requirements.

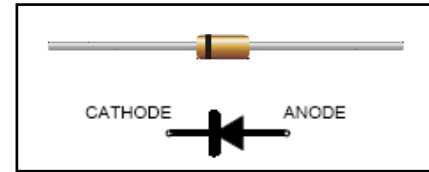

Ta=25 V_Fmax=1.1V @ I_F=200mA P=500(mW)

TYPE	Nominal Zener Voltage Vz@Lzt Volts	Test Current Izt mA	Max Zener Impedance A and B Suffix only		Max Reverse Leakage Current		Max Zener Voltage Temperature Coff (A and B suffix only) VZ(%/)
			Zzt @ Izt Ohms	Zzk @ Izk=0.25mA Ohms	I _R uA Max	V _R Volts B	
1N5221B	2.4		30	1200	100		-0.085
1N5222B	2.5		30	1250	100		-0.085
1N5223B	2.7	20	30	1300	75	1.0	-0.08
1N5224B	2.8		30	1400	75		-0.08
1N5225B	3.0		29	1600	50		-0.075
1N5226B	3.3		28	1600	25	1.0	-0.07
1N5227B	3.6		24	1700	15	1.0	-0.065
1N5228B	3.9	20	23	1900	10	1.0	-0.06
1N5229B	4.3		22	2000	5.0	1.0	±0.055
1N5230B	4.7		19	1900	5.0	2.0	±0.03
1N5231B	5.1		17	1600	5.0	2.0	±0.03
1N5232B	5.6		11	1600	5.0	3.0	+0.038
1N5233B	6	20	7.0	1600	5.0	3.5	+0.038
1N5234B	6.2		7.0	1000	5.0	4.0	+0.045
1N5235B	6.8		5.0	750	3.0	5.0	+0.05
1N5236B	7.5		6.0	500		6.0	+0.058
1N5237B	8.2		8.0	500		6.5	+0.062
1N5238B	8.7	20	8.0	600	3.0	6.5	+0.065
1N5239B	9.1		10	600		7.0	+0.068
1N5240B	10		17	600		8.0	+0.075
1N5241B	11	20	22		2.0	8.4	+0.076
1N5242B	12	20	30		1.0	9.1	+0.077
1N5243B	13	9.5	13	600	0.5	9.9	+0.079
1N5244B	14	9.0	15		0.1	10	+0.082
1N5245B	15	8.5	16		0.1	11	+0.082
1N5246B	16	7.8	17			12	+0.083
1N5247B	17	7.4	19			13	+0.084
1N5248B	18	7.0	21	600	0.1	14	+0.085
1N5249B	19	6.6	23			14	+0.086
1N5250B	20	6.2	25			15	+0.086

1N5251B	22	5.6	29			17	+0.087
1N5252B	24	5.2	33			18	+0.088
1N5253B	25	5.0	35	600	0.1	19	+0.089
1N5254B	27	4.6	41			21	+0.090
1N5255B	28	4.5	44			21	+0.091
1N5256B	30	4.2	49	600		23	+0.091
1N5257B	33	3.8	58	700		25	+0.092
1N5258B	36	3.4	70	700	0.1	27	+0.093
1N5259B	39	3.2	80	800		30	+0.094
1N5260B	43	3.0	93	900		33	+0.095

* suffix B: $V_z \pm 5\%$

* tested with pulse (40 ms).

Characteristic Curves

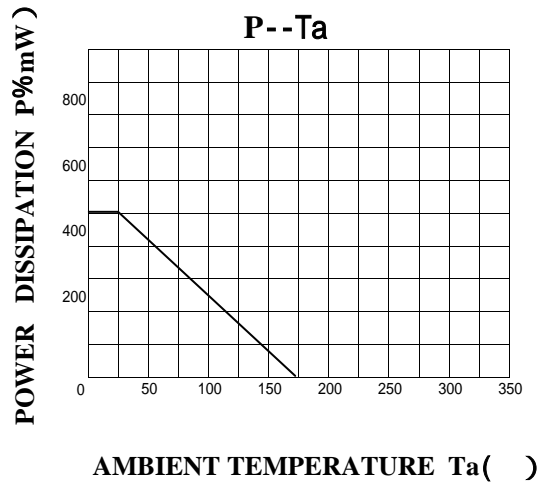
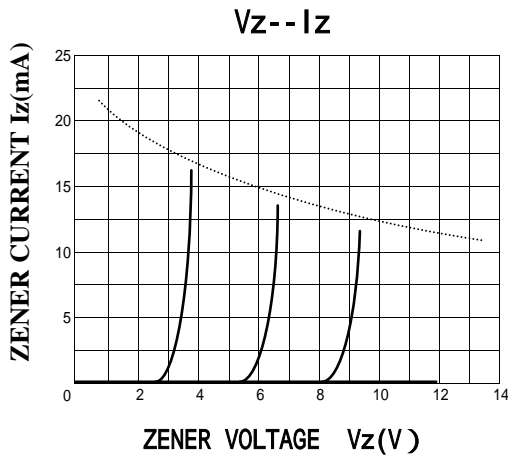

Package Dimensions in inches and (millimeters)

DIM	MILLIMETERS		INCHES	
	MIN	MAX	MIN	MAX
A	3.6	4.0	0.14	0.157
B	1.6	2.0	0.063	0.079
D	0.4	0.6	0.016	0.024
K	28	30	1.102	1.181

D0-35

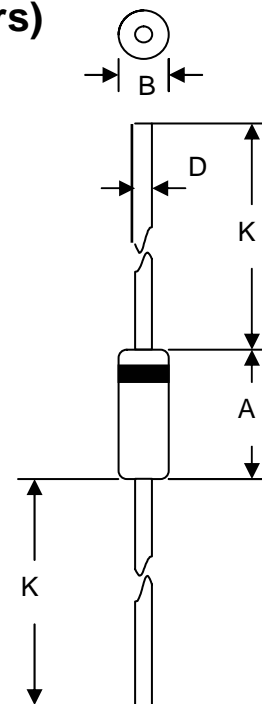

D0-35

Packing

Taping / Box(T52)

Tape Inner Box:5000pcs/each

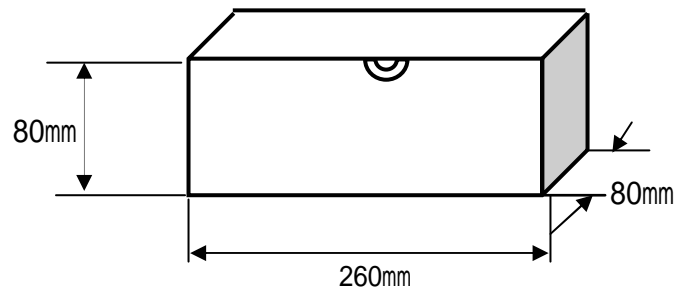

Taping / Box(T26)

Tape Inner Box:5000pcs/each

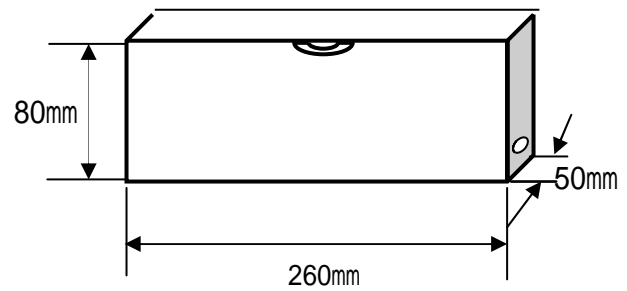

Bulk

500pcs/bag

10000pcs /each

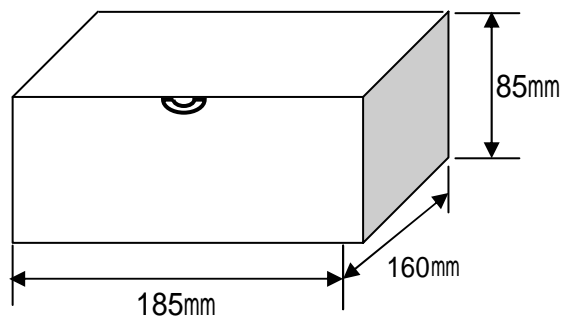

Reel (T52)

10000pcs/卷

