



Micro Commercial Components

Micro Commercial Components  
 20736 Marilla Street Chatsworth  
 CA 91311  
 Phone: (818) 701-4933  
 Fax: (818) 701-4939

# CMP SH-3/3A/3C/3S

## Features

- Low Current Leakage
- For Surface Mount Applications
- Case Material: Molded Plastic. UL Flammability Classification Rating 94V-0

**350mW 30Volt  
 Switching Diode**

## Maximum Ratings

- Operating Temperature: -55°C to +150°C
- Storage Temperature: -55°C to +150°C

## SOT-23

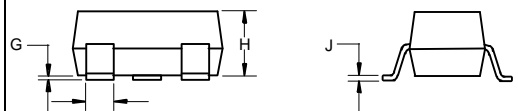
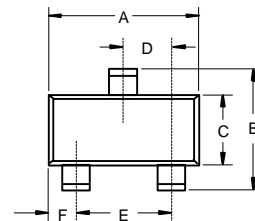

DIMENSIONS

DIM	INCHES		MM		NOTE
	MIN	MAX	MIN	MAX	
A	.110	.120	2.80	3.04	
B	.083	.098	2.10	2.64	
C	.047	.055	1.20	1.40	
D	.035	.041	.89	1.03	
E	.070	.081	1.78	2.05	
F	.018	.024	.45	.60	
G	.0005	.0039	.013	.100	
H	.035	.044	.89	1.12	
J	.003	.007	.085	.180	
K	.015	.020	.37	.51	

## Suggested Solder Pad Layout

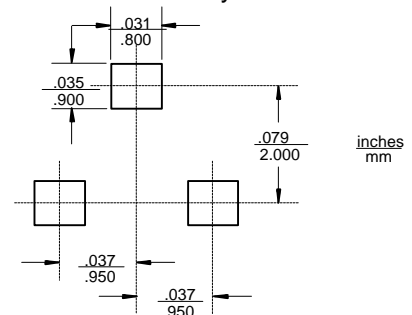

## Electrical Characteristics @ 25°C Unless Otherwise Specified

Reverse Voltage	$V_R$	30V	
Average Rectified Current	$I_O$	100mA	
Power Dissipation	$P_{TOT}$	350mW	
Maximum Instantaneous Forward Voltage	$V_F$	0.33V 0.45V 1.0V	$I_{FM} = 2mA;$ $I_{FM} = 15mA;$ $I_{FM} = 100mA;$
Maximum DC Reverse Current At Rated DC Blocking Voltage	$I_R$	500nA 100µA	$V_R = 25Volts$ $T_J = 25^\circ C$ $T_J = 100^\circ C$
Typical Junction Capacitance	$C_J$	4pF	Measured at 1.0MHz, $V_R = 0V$
Reverse Recovery Time	$T_{rr}$	4nS	$I_F = I_R = 10mA$ $I_{RR} = 1.0mA$ $R_L = 100\Omega$

\*Pulse test: Pulse width 300 µsec, Duty cycle 2%

# CMP SH-3/3A/3C/3S

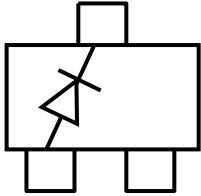

CMP SH-3 Marking: D95

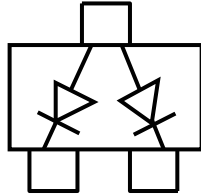

CMP SH-3A Marking: DB1

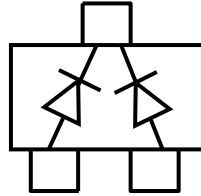

CMP SH-3C Marking: DB2

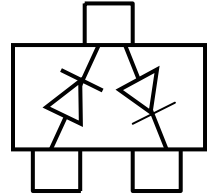

CMP SH-3S Marking: DA5



TM

Micro Commercial Components

**\*\*\*IMPORTANT NOTICE\*\*\***

*Micro Commercial Components Corp.* reserves the right to make changes without further notice to any product herein to make corrections, modifications, enhancements, improvements, or other changes. *Micro Commercial Components Corp.* does not assume any liability arising out of the application or use of any product described herein; neither does it convey any license under its patent rights, nor the rights of others. The user of products in such applications shall assume all risks of such use and will agree to hold *Micro Commercial Components Corp.* and all the companies whose products are represented on our website, harmless against all damages.

**\*\*\*APPLICATIONS DISCLAIMER\*\*\***

Products offer by *Micro Commercial Components Corp.* are not intended for use in Medical, Aerospace or Military Applications.