

## Surface Mount Plastic PIN Diodes

Rev. V22

### Features

- Industry Standard Surface Mount Packages
- Lead-Free (RoHS Compliant) Equivalents Available with 260 °C Reflow Compatibility
- Low Loss, High Isolation Switching Diodes
- Low Distortion Attenuator Diodes
- Single and Dual Diode Configurations
- Tape and Reel Packaging

### Description and Applications

M/A-COM offers silicon PIN diodes in five standard, low cost, surface mount plastic packages for use as switches and attenuators. These diodes are offered with standard Sn/Pb plating, as well as with 100% matte Sn plating on our RoHS compliant devices. M/A-COM's PIN diodes feature a variety of I-region lengths resulting in lower resistance, and lower capacitance devices for various microwave control circuit applications.

The MA4P275/MA4P7436/MADP-007436 series offer the lowest series resistance for best performance as low loss series switches and high isolation shunt switches.

The MA4P789/ MA4P7433/MADP-007433 series have the lowest capacitance and offers the highest isolation in series and series-shunt switches through 3GHz.

The MA4P282/ MA4P7447/MADP-007155 series, the MA4P274/MA4P7455/ MADP-007455 series and the MADP-007448 series are general purpose PIN diodes useful as either switches or attenuators.

The MA4P277/MA4P7437/MADP-007437 series and MA4P278/MA4P7438/MADP-007438 series device have thicker intrinsic regions to provide lower distortion in attenuator circuits.

The MA4P290/MADP-007167 series devices have the thickest I-Region, offering the lowest distortion and highest IP3 for current controlled attenuator circuits. These devices are ideal for AGC functions for infrastructure and CATV applications.

These parts are available as single diodes, series tees (ST), series tee reverse (STR), common cathode pairs (CK), common anode pairs (CA), and unconnected pairs in the respective featured packages.

M/A-COM's PIN diodes are available in the SOT-23 (case style 287), the SOT-143 (case style 1068), the SOT-323/SC-70 (3L) (case style 1146), the SOD-323 (case style 1141), and the SC-79 (case style 1279) packages. These packages are supplied on tape and reel for automatic pick and place assembly. The tape and reel suffix designation is a "T" at the end of the part number.

### Package Outlines

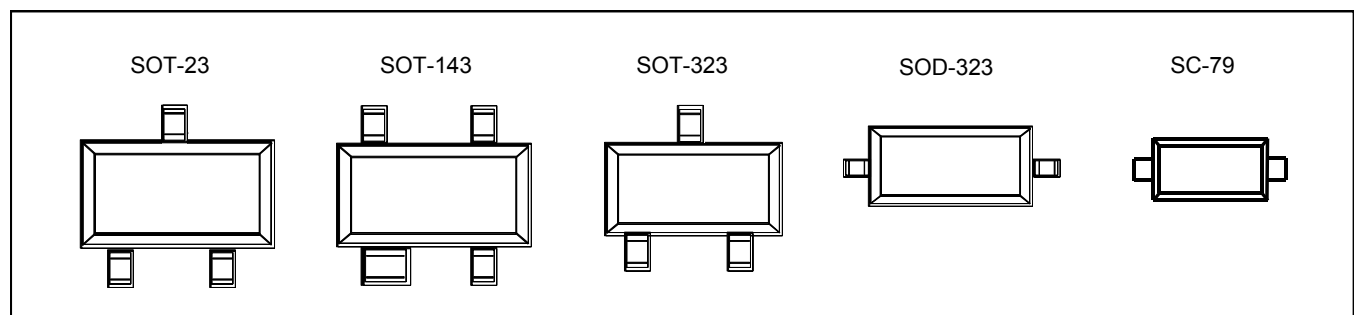

## Surface Mount Plastic PIN Diodes

Rev. V22

### Absolute Maximum Ratings @ 25 °C<sup>1</sup> (Unless Otherwise Noted)

Parameter	Absolute Maximum
Operating Temperature	-65°C to +150 °C
Storage Temperature	-65°C to +125 °C
Junction Temperature	+ 175 °C
RF C.W. Incident Power @ 25 °C: MA4P282 / MA4P7447/MADP-007155 Series ( $\theta$ die = 15 °C/ W ), RF & DC Incident De-rating Coefficient = - 21.3 mW / °C MA4P275 / MA4P7436/MADP-007436 Series ( $\theta$ die = 25 °C/ W ), RF & DC Incident De-rating Coefficient = - 16.8 mW / °C MA4P278 / MA4P7438/MADP-007438 Series ( $\theta$ die = 30 °C/ W ), RF & DC Incident De-rating Coefficient = - 13.3 mW / °C MA4P274 / MA4P7455/MADP-007455 Series ( $\theta$ die = 35 °C/ W ), RF & DC Incident De-rating Coefficient = - 13.3 mW / °C MA4P277 / MA4P7437/MADP-007437 Series ( $\theta$ die = 45 °C/ W ), RF & DC Incident De-rating Coefficient = - 13.3 mW / °C MA4P290 / MADP-007167 Series ( $\theta$ die = 55 °C/ W ), RF & DC Incident De-rating Coefficient = - 13.3 mW / °C MA4P789 / MA4P7433/MADP-007433 Series ( $\theta$ die = 80 °C/ W ), RF & DC Incident De-rating Coefficient = - 10.7 mW / °C MADP-007448 Series ( $\theta$ die = 80 °C/ W ), RF & DC Incident De-rating Coefficient = - 10.7 mW / °C	+ 32 dBm + 31 dBm + 30 dBm + 30 dBm + 30 dBm + 30 dBm + 29 dBm + 32 dBm
Total ( RF + DC ) Power Dissipation @ 25 °C ( SOT-23, SOT-143 ) : RF & DC Dissipated De-rating Coefficient = - 33.3 mW / °C ( SOT-323, SOD-323, SC-79 ) : RF & DC Dissipated De-rating Coefficient = - 26.7 mW / °C	250 mW 200 mW
Reverse Voltage	Voltage Rating
Forward Current	150 mA DC

1. Operation of these devices above any one of these parameters may cause permanent damage.

### Electrical Specifications @ 25°C

Standard Part Number	RoHS Compliant Part Number	Reverse Voltage <sup>2</sup> (V)	Total Capacitance <sup>3</sup> Max. (pF)	Nominal Characteristics		
				RS @ 10 mA <sup>4</sup> Max. (Ohms)	Carrier Lifetime <sup>5</sup> (μs)	I-Region Thickness (mils)
MA4P275	MA4P7436 MADP-007436 Series	75	1.00 @ 20V	0.5	0.2	0.4
MA4P789	MA4P7433 MADP-007433 Series	75	0.35 @ 20V	1.5	0.2	0.4
MA4P282	MA4P7447 MADP-007155 Series	100	1.20 @ 20V	0.6	1.0	0.8
	MADP-007448 Series	100	0.25 @ 50V	2.0	0.4	0.6
MA4P274	MA4P7455 MADP-007455 Series	100	0.35 @ 50V	3.0	1.0	2.0
MA4P277	MA4P7437 MADP-007437 Series	200	0.35 @ 50V	6.0	2.0	4.0
MA4P278	MA4P7438 MADP-007438 Series	200	0.35 @ 50V	10.0	3.0	5.0
MA4P290	MADP-007167	200	0.30 @ 50V	16.0	3.0	7.0

2. The reverse current will not exceed 10 μA at the reverse voltage rating.

## Surface Mount Plastic PIN Diodes

Rev. V22

### Packaging and Configurations

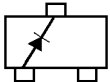
					
Single				Single	
SC-79		SOD-323		SOT-23	
Standard Part Number	RoHS Compliant Part Number	Standard Part Number	RoHS Compliant Part Number	Standard Part Number	RoHS Compliant Part Number
	MADP-007436-12790T		MA4P7436-1141T	MA4P275-287T	MA4P7436-287T
	MADP-007433-12790T		MA4P7433-1141T	MA4P789-287T	MA4P7433-287T
			MA4P7447-1141T	MA4P282-287T	MA4P7447-287T
	MADP-007448-12790T		MADP-007448-11410T		MADP-007448-0287AT
	MADP-007455-12790T		MA4P7455-1141T	MA4P274-287T	MA4P7455-287T
			MA4P7437-1141T	MA4P277-287T	MA4P7437-287T
			MA4P7438-1141T	MA4P278-287T	MA4P7438-287T
			MADP-007167-11410T	MA4P290-287T	MADP-007167-0287AT
L <sub>S</sub> = 0.6 nH		L <sub>S</sub> = 1.3 nH		L <sub>S</sub> = 1.4 nH	
C <sub>p</sub> = 0.10 pF		C <sub>p</sub> = 0.11 pF		C <sub>p</sub> = 0.12 pF	

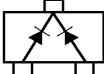
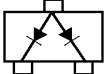
							
Common Cathode				Common Anode			
SOT-23		SC70 (3L)		SOT-23		SC70 (3L)	
Standard Part Number	RoHS Compliant Part Number	Standard Part Number	RoHS Compliant Part Number	Standard Part Number	RoHS Compliant Part Number	Standard Part Number	RoHS Compliant Part Number
MA4P275CK-287T	MA4P7436CK-287T	MA4P275CK-1146T	MA4P7436CK-1146T	MA4P275CA-287T	MA4P7436CA-287T	MA4P275CA-1146T	MA4P7436CA-1146T
MA4P289CK-287T	MA4P7433CK-287T	MA4P789CK-1146T	MA4P7433CK-1146T	MA4P789CA-287T	MA4P7433CA-287T	MA4P789CA-1146T	MA4P7433CA-1146T
MA4P282CK-287T	MA4P7447CK-287T			MA4P282CA-287T	MA4P7447CA-287T		
	MADP-007448-0287FT				MADP-007448-0287GT		MADP-007448-1146GT
MA4P274CK-287T	MA4P7455CK-287T	MA4P274CK-1146T	MA4P7455CK-1146T	MA4P274CA-287T	MA4P7455CA-287T	MA4P274CA-1146T	MA4P7455CA-1146T
MA4P277CK-287T	MADP-007437-0287FT			MA4P277CA-287T	MA4P7437CA-287T		
MA4P278CK-287T	MADP-007438-0287FT			MA4P278CA-287T	MA4P7438CA-287T		
MA4P290CK-287T	MADP-007167-0287FT				MADP-007167-0287GT		
L <sub>S</sub> = 1.4 nH		L <sub>S</sub> = 1.3 nH		L <sub>S</sub> = 1.4 nH		L <sub>S</sub> = 1.3 nH	
C <sub>p</sub> = 0.12 pF		C <sub>p</sub> = 0.12 pF		C <sub>p</sub> = 0.12 pF		C <sub>p</sub> = 0.12 pF	

### Packaging and Configurations

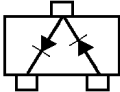
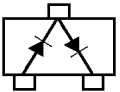
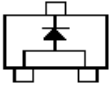
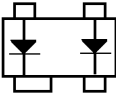
							
Series Tee				Series Tee Reverse			
SOT-23		SC70 (3L)		SOT-23		SC70 (3L)	
Standard Part Number	RoHS Compliant Part Number	Standard Part Number	RoHS Compliant Part Number	Standard Part Number	RoHS Compliant Part Number	Standard Part Number	RoHS Compliant Part Number
MA4P275ST-287T	MA4P7436ST-287T	MA4P275ST-1146T	MA4P7436ST-1146T	MA4P275STR-287T	MADP-007436-0287DT	MA4P275STR-1146T	MADP-007436-1146DT
MA4P789ST-287T	MA4P7433ST-287T	MA4P789ST-1146T	MA4P7433ST-1146T	MA4P789STR-287T	MADP-007433-0287DT	MA4P789STR-1146T	MADP-007433-1146DT
MA4P282ST-287T	MA4P7447ST-287T			MA4P282STR-287T	MADP-007155-0287DT		
	MADP-007448-0287BT		MADP-007448-1146BT		MADP-007448-0287DT		MADP-007448-1146DT
MA4P274ST-287T	MA4P7455ST-287T	MA4P274ST-1146T	MA4P7455ST-1146T	MA4P274STR-287T	MADP-007455-0287DT	MA4P274STR-1146T	MADP-007455-1146DT
MA4P277ST-287T	MADP-007437-0287BT			MA4P277STR-287T	MADP-007437-0287DT		
MA4P278ST-287T	MADP-007438-0287BT			MA4P278STR-287T	MADP-007438-0287DT		
	MADP-007167-0287BT			MA4P290STR-287T	MADP-007167-0287DT		
L <sub>S</sub> = 1.4 nH		L <sub>S</sub> = 1.3 nH		L <sub>S</sub> = 1.4 nH		L <sub>S</sub> = 1.3 nH	
							
Low Inductance				Unconnected Pair			
SOT-23		SOT-143		SOT-23		SOT-143	
Standard Part Number	RoHS Compliant Part Number	Standard Part Number	RoHS Compliant Part Number	Standard Part Number	RoHS Compliant Part Number	Standard Part Number	RoHS Compliant Part Number
MA4P290-LI-287T	MADP-007167-0287HT			MA4P275-1068T		MA4P7436-1068T	
	MADP-007433-0287HT			MA4P789-1068T		MA4P7433-1068T	
						MADP-007448-1068ET	
				MA4P274-1068T		MA4P7455-1068T	
LS = 0.4 nH				LS = 1.3 nH			
CP = 0.12 pF				CP = 0.12 pF			

### Typical Forward Resistance vs DC Bias Current Curves @ 100 MHz

**Resistance vs Forward Current**  
(MA4P274 / MA4P7455 / MADP-007155 Series)

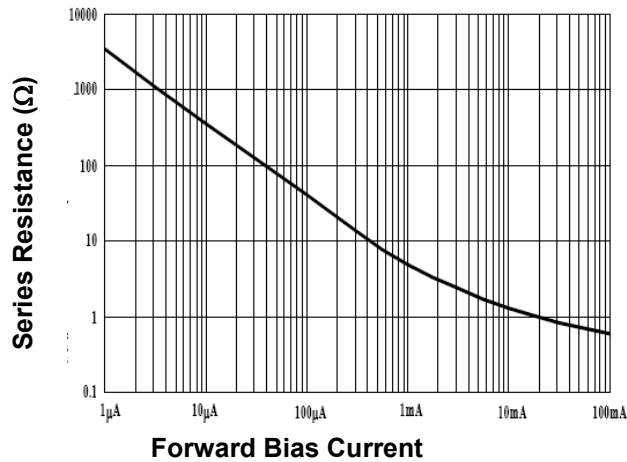

**Resistance vs Forward Current**  
(MA4P275 / MA4P7436 / MADP-007436 Series)

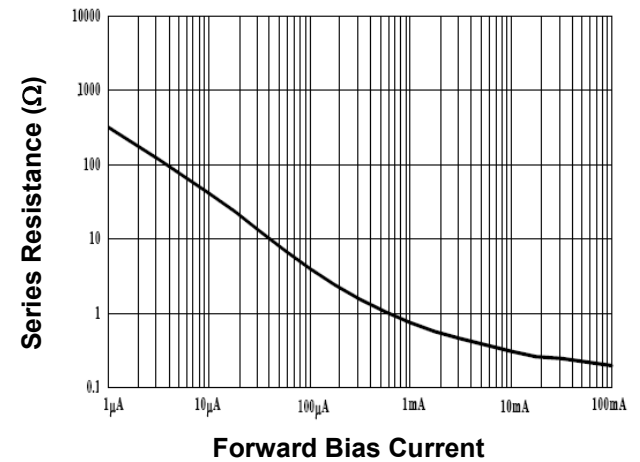

**Resistance vs Forward Current**  
(MA4P277 / MA4P7437 / MADP-007437 Series)

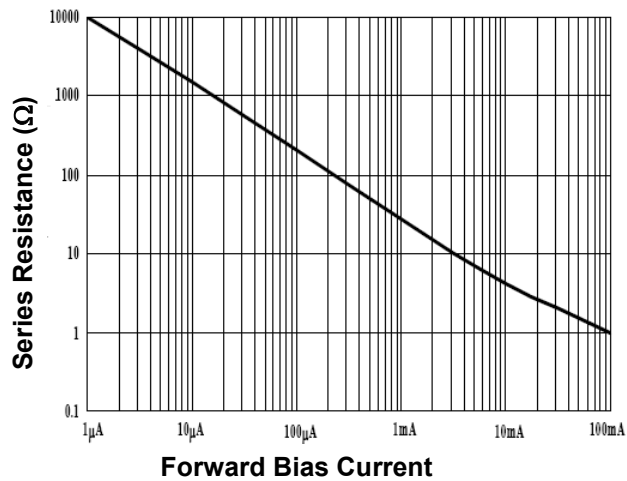

**Resistance vs Forward Current**  
(MA4P278 / MA4P7438 / MADP-007438 Series)

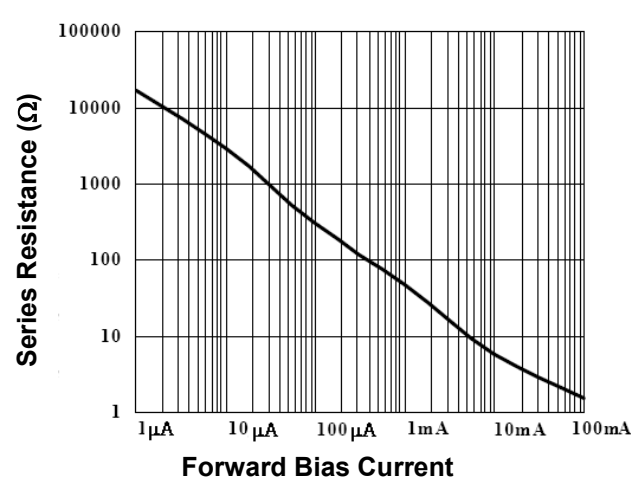

### Typical Forward Resistance vs DC Bias Current Curves @ 100 MHz

**Resistance vs Forward Current**  
(MA4P282 / MA4P7447 / MADP-007155 Series)

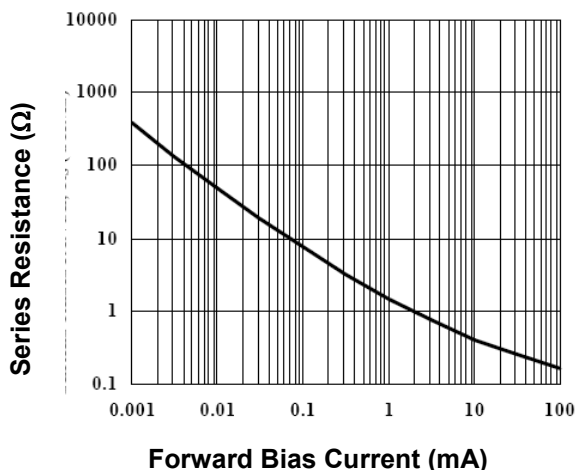

**Resistance vs Forward Current**  
(MA4P789 / MA4P7433/ MADP-007433 Series)

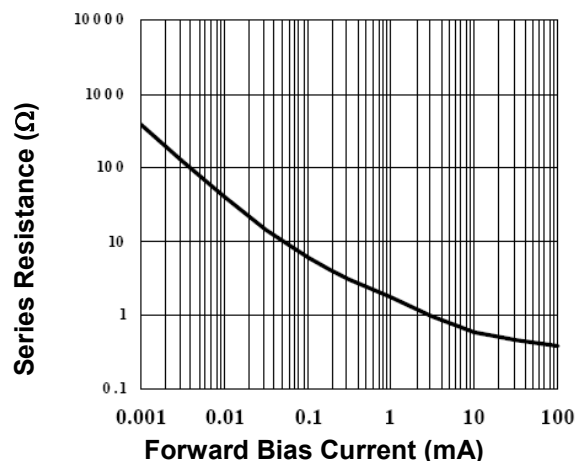

**Resistance vs Forward Current**  
(MA4P290 / MADP-007167 Series)

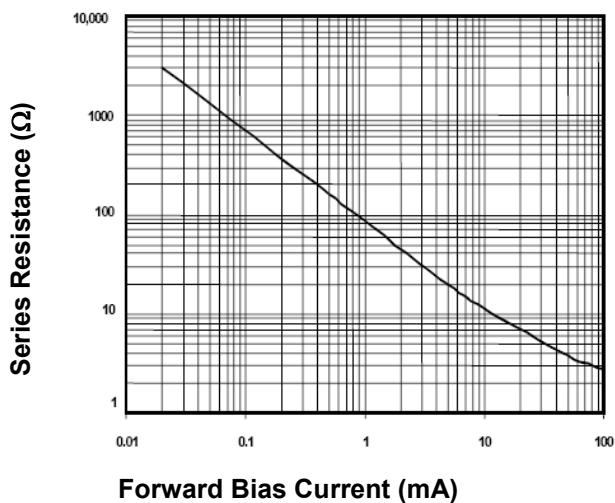

**Resistance vs Forward Current**  
(MADP-007448 Series)

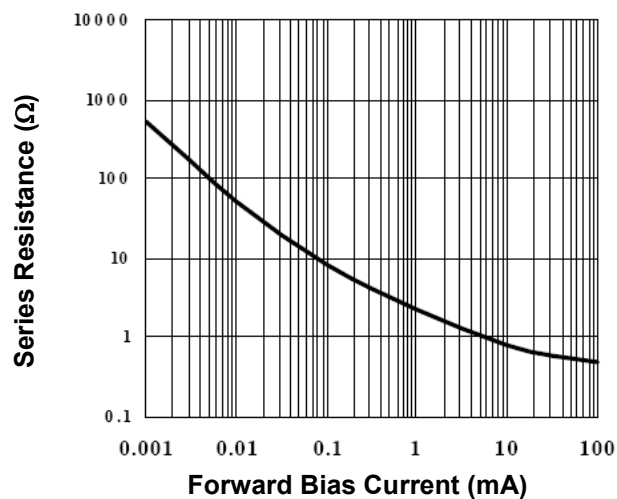

### Case Styles

#### SOT-23

#### Case Style 287

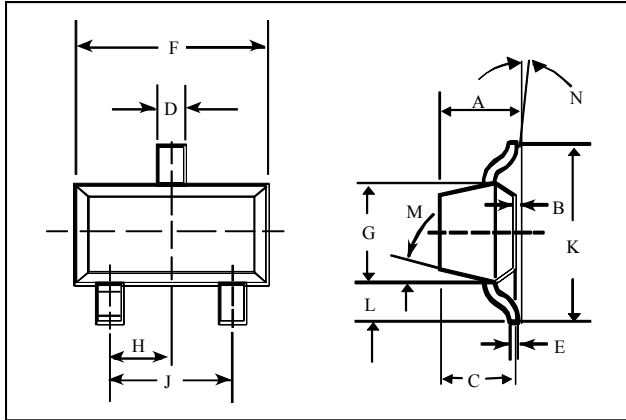

#### SOT-23 (Case Style 287)

DIM.	INCHES		MILLIMETERS	
	MIN.	MAX.	MIN.	MAX.
A	—	0.048	—	1.22
B	—	0.008	—	0.20
C	—	0.040	—	1.00
D	0.013	0.020	0.35	0.50
E	0.003	0.006	0.08	0.15
F	0.110	0.119	2.80	3.00
G	0.047	0.056	1.20	1.40
H	0.037 typical		0.95 typical	
J	0.075 typical		1.90 typical	
K	—	0.103	—	2.60
L	—	0.024	—	0.60
<b>DIM.</b>	<b>GRADIENT</b>			
M	10° max. <sup>6</sup>			
N	2° . . .30°			

6. Applicable on all sides

#### SC-70, 3 Lead (Case Style 1146)

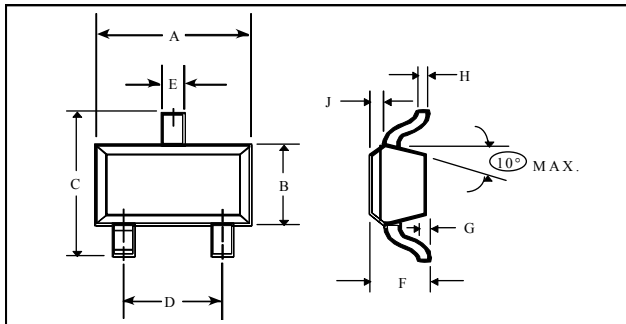

DIM.	INCHES		MILLIMETERS	
	MIN.	MAX.	MIN.	MAX.
A	0.071	0.087	1.80	2.21
B	0.045	0.053	1.14	1.35
C	0.071	0.094	1.80	2.39
D	0.047	0.057	1.19	1.45
E	0.010	0.016	0.25	0.41
F	0.031	0.039	0.79	1.00
G	0.000	0.004	0.00	0.10
H	0.004	0.007	0.10	0.18
J	0.004	0.010	0.10	0.25

#### SC-79 (Case Style 1279)

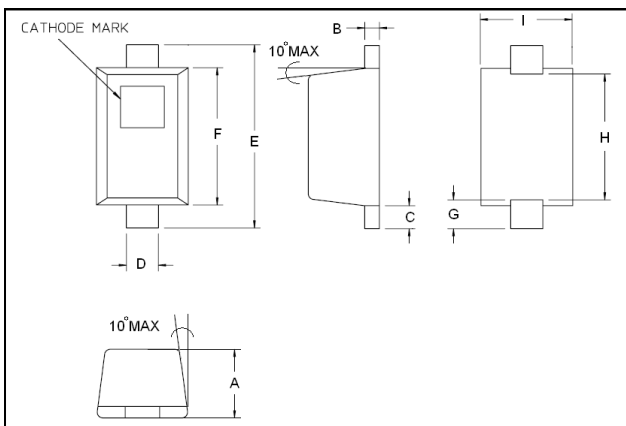

DIM.	INCHES		MILLIMETERS	
	MIN.	MAX.	MIN.	MAX.
A	.0197	.0276	0.50	0.70
B	0.003	0.008	0.07	0.20
C	0.006	0.010	0.15	0.25
D	0.010	0.014	0.25	0.35
E	0.059	0.067	1.50	1.70
F	0.043	0.051	1.09	1.30
G	.0098 nominal		0.250 nominal	
H	.0433 nominal		1.10 nominal	
I	.027	.035	0.68	0.89

### Case Styles (Cont'd)

#### SOD-323 (Case Style 1141)

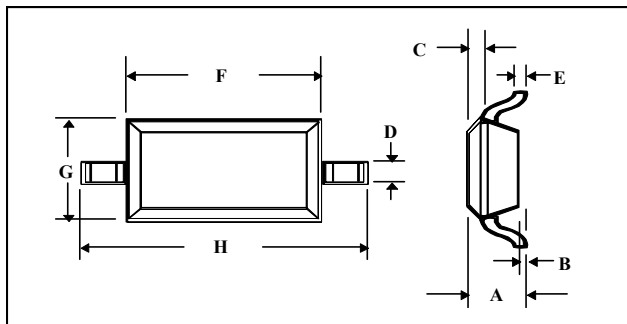

DIM.	INCHES		MILLIMETERS	
	MIN.	MAX.	MIN.	MAX.
A	—	0.043	—	1.1
B	—	0.004	—	0.1
C	—	0.008	—	0.2
D	0.010	0.016	0.25	0.41
E	0.003	0.006	0.07	0.15
F	0.063	0.075	1.6	1.9
G	0.045	0.057	1.14	1.45
H	0.091	0.106	2.3	2.7

#### SOT-143

#### Case Style 1068

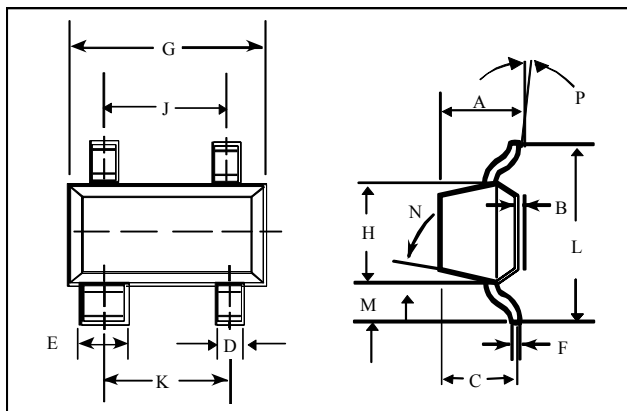

#### SOT-143 (Case Style 1068)

DIM.	INCHES		MILLIMETERS	
	MIN.	MAX.	MIN.	MAX.
A	—	0.044	—	1.10
B	—	0.004	—	0.10
C	—	0.040	—	1.00
D	0.013	0.020	0.35	0.50
E	0.030	0.035	0.75	0.90
F	0.003	0.006	0.08	0.15
G	0.110	0.119	2.80	3.00
H	0.047	0.056	1.20	1.40
J	0.075 typical		1.90 typical	
K	0.075 typical		1.90 typical	
L	—	0.103	—	2.6
M	—	0.024	—	0.6
<b>DIM.</b>	<b>GRADIENT</b>			
M	10° max. <sup>7</sup>			
N	2° . . . 30°			

7. Applicable on all sides



### Mounting Information

The illustration indicates the recommended mounting pad configuration for the SOT-23, SOT-323, SOD-323, SOT-143, and SC-79 packages. Solder paste containing flux should be screened onto the pads to a thickness of 0.005-0.007 inches. The plastic package is placed in position, firmly adhering to the solder paste.

Permanent attachment is performed by a reflow soldering procedure during which the tab temperature does not exceed +275 °C and the body temperature does not exceed +250 °C, for standard models and +260 °C for the RoHS compliant devices.

Please refer to Application Note M538 for surface mounting instructions.

### SOT-23

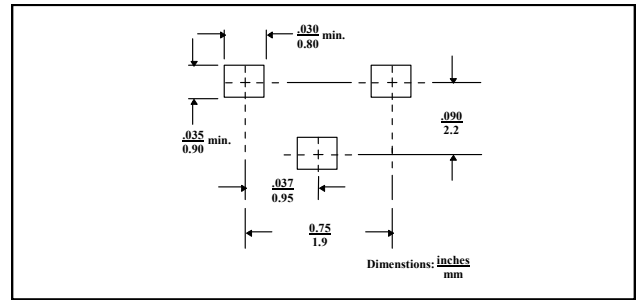

### SOD-323

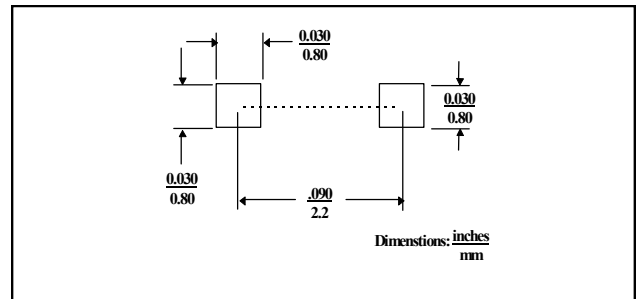

### SOT-323

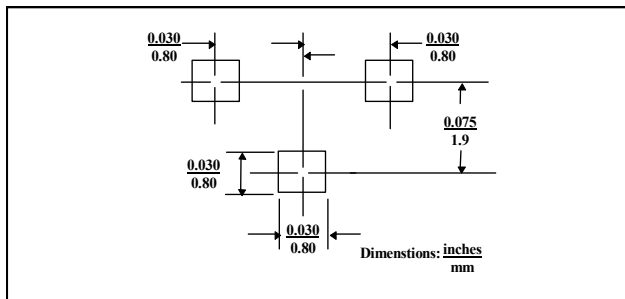

### SOT-143

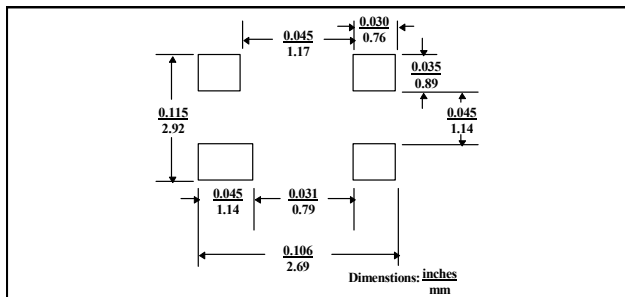

### SC-79

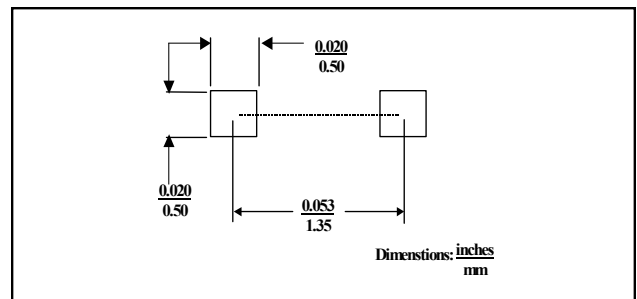

M/A-COM Technology Solutions Inc. All rights reserved.

Information in this document is provided in connection with M/A-COM Technology Solutions Inc ("MACOM") products. These materials are provided by MACOM as a service to its customers and may be used for informational purposes only. Except as provided in MACOM's Terms and Conditions of Sale for such products or in any separate agreement related to this document, MACOM assumes no liability whatsoever. MACOM assumes no responsibility for errors or omissions in these materials. MACOM may make changes to specifications and product descriptions at any time, without notice. MACOM makes no commitment to update the information and shall have no responsibility whatsoever for conflicts or incompatibilities arising from future changes to its specifications and product descriptions. No license, express or implied, by estoppel or otherwise, to any intellectual property rights is granted by this document.

THESE MATERIALS ARE PROVIDED "AS IS" WITHOUT WARRANTY OF ANY KIND, EITHER EXPRESS OR IMPLIED, RELATING TO SALE AND/OR USE OF MACOM PRODUCTS INCLUDING LIABILITY OR WARRANTIES RELATING TO FITNESS FOR A PARTICULAR PURPOSE, CONSEQUENTIAL OR INCIDENTAL DAMAGES, MERCHANTABILITY, OR INFRINGEMENT OF ANY PATENT, COPYRIGHT OR OTHER INTELLECTUAL PROPERTY RIGHT. MACOM FURTHER DOES NOT WARRANT THE ACCURACY OR COMPLETENESS OF THE INFORMATION, TEXT, GRAPHICS OR OTHER ITEMS CONTAINED WITHIN THESE MATERIALS. MACOM SHALL NOT BE LIABLE FOR ANY SPECIAL, INDIRECT, INCIDENTAL, OR CONSEQUENTIAL DAMAGES, INCLUDING WITHOUT LIMITATION, LOST REVENUES OR LOST PROFITS, WHICH MAY RESULT FROM THE USE OF THESE MATERIALS.

MACOM products are not intended for use in medical, lifesaving or life sustaining applications. MACOM customers using or selling MACOM products for use in such applications do so at their own risk and agree to fully indemnify MACOM for any damages resulting from such improper use or sale.

10

---

M/A-COM Technology Solutions Inc. (MACOM) and its affiliates reserve the right to make changes to the product(s) or information contained herein without notice.  
Visit [www.macom.com](http://www.macom.com) for additional data sheets and product information.