

Programmable Shunt Regulator

BL431R

FEATURES

- Programmable output voltage to 36 volts
- Low dynamic output impedance 0.20 typical
- Sink current capability of 1.0 to 100mA
- Equivalent full-range temperature coefficient of 50ppm/°C typical
- Temperature compensated for operation over full rated Operating temperature range
- Low output noise voltage
- Fast turn-on response

HF

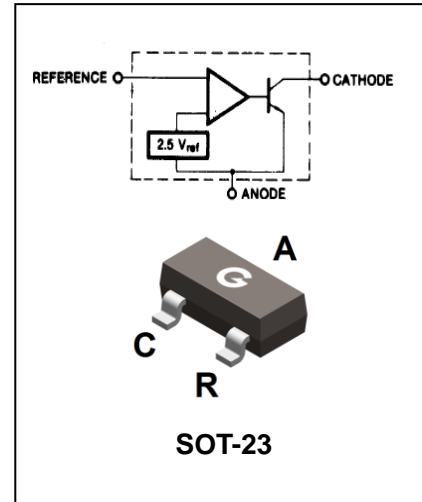

ORDERING INFORMATION

Type No.	Marking	Package Code
BL431R	431R	SOT-23

MAXIMUM RATING @ Ta=25°C unless otherwise specified

Parameter	symbol	limits	unit
Electrostatic discharge Human-body model(HBM),per ANSI/ESDA/JEDEC JS-001 ^(Note1)	V _(ESD)	±2000	V
Electrostatic discharge Charged-device model(CDM), per JEDEC specification JESD22C101 ^(Note2)		±1000	
Cathode Voltage	V _{KA}	37	V
Cathode current Range(Continuous)	I _{KA}	-100 to +150	mA
Reference Input Current Range	I _{REF}	0.05 to 10	mA
Power dissipation	P _D	350	mW
Operating temperature Range	T _{OPR}	-40 to +105	°C
Storage temperature Range	T _{STG}	-65 to +150	°C

Notes:

1. JEDEC document JEP155 states that 500-v HBM allows safe manufacturing with a standard ESD control process. Manufacturing with less than 500-v HBM is possible with the necessary precautions.
2. JEDEC document JEP157 states that 250-v CDM allows safe manufacturing with a standard ESD control process. Manufacturing with less than 250-v CDM is possible with the necessary precautions.

Programmable Shunt Regulator

BL431R

Recommended Operating Conditions

Parameter	symbol	Min	Typ	Max	Unit
Cathode Voltage	V_{KA}	V_{REF}	-	36	V
Cathode Current	I_{KA}	1.0	-	100	mA

ELECTRICAL CHARACTERISTICS @ $T_a=25^\circ\text{C}$ unless otherwise specified

Parameter	symbol	conditions	Min.	Typ.	Max.	unit
Reference Input voltage	V_{REF}	$V_{KA}=V_{REF}, I_{KA}=10\text{mA}$	2.44	2.5	2.55	V
Deviation of Reference Input Voltage Over-Temperature (Note1)	$\Delta V_{REF}/\Delta T$	$V_{KA}=V_{REF}, I_{KA}=10\text{mA}, T_{MIN} \leq T_A \leq T_{MAX}$		4.5	17	mV
Ratio of Change in Reference Input Voltage to the Change in Cathode Voltage	$\Delta V_{REF}/\Delta V_{KA}$	$I_{KA}=10\text{mA}$ $\Delta V_{KA}=10\text{V}-V_{REF}$	-2.7	-1.0		mV/V
		$\Delta V_{KA}=36\text{V}-10\text{V}$	-2.0	-0.5		
Reverse Input current	I_{REF}	$I_{KA}=10\text{mA}, R_1=10\text{K}\Omega, R_2=\infty$		1.5	4	μA
Deviation of Reference Input Current Over Full Temperature Range	$\Delta I_{REF}/\Delta T$	$I_{KA}=10\text{mA}, R_1=10\text{K}\Omega, R_2=\infty, T_A=\text{Full Range}$		0.4	1.2	μA
Minimum Cathode Current for Regulation	$I_{KA(MIN)}$	$V_{KA}=V_{REF}$		0.19	0.5	mA
Off-Stage Cathode Current	$I_{KA(OFF)}$	$V_{KA}=36\text{V}, V_{REF}=0$		0.05	1.0	μA
Dynamic Impedance(Note2)	Z_{ZA}	$V_{KA}=V_{REF}, I_{KA}=1 \text{ to } 100\text{mA}, f \geq 1.0\text{KHz}$		0.15	0.5	Ω

• $T_{MIN}=-25^\circ\text{C}, T_{MAX}=+85^\circ\text{C}$

CLASSIFICATION OF V_{ref}

Rank	0.5%	1%	2%
Range	2.488-2.512	2.475-2.525	2.450-2.550

Programmable Shunt Regulator

BL431R

TYPICAL CHARACTERISTICS @ $T_a=25^\circ\text{C}$ unless otherwise specified

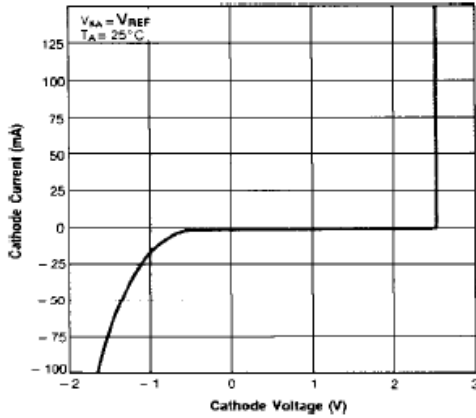

Figure 1. Cathode Current vs. Cathode Voltage

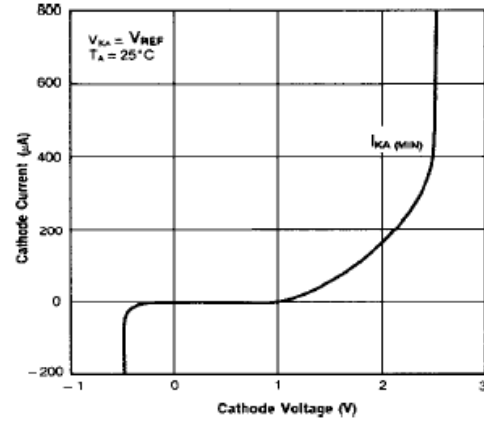

Figure 2. Cathode Current vs. Cathode Voltage

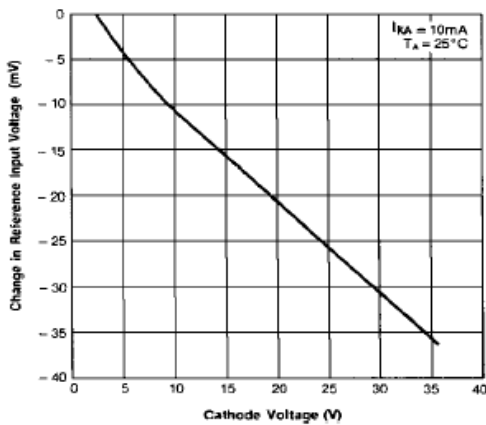

Figure 3. Change In Reference Input Voltage vs. Cathode Voltage

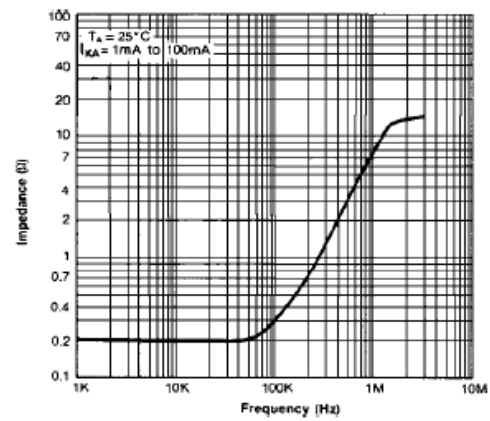

Figure 4. Dynamic Impedance Frequency

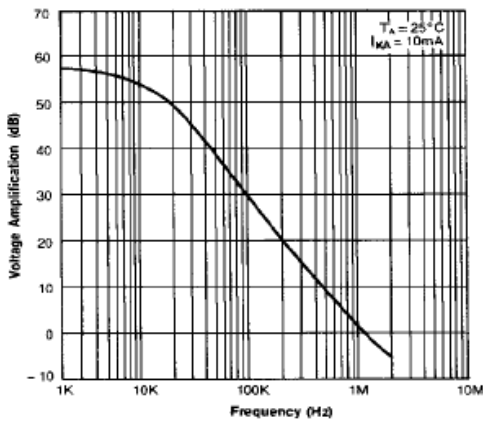

Figure 5. Small Signal Voltage Amplification vs. Frequency

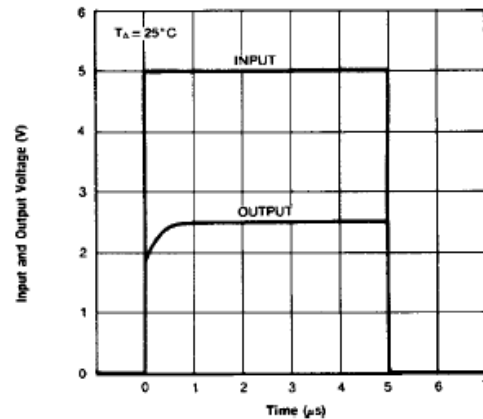

Figure 6. Pulse Response

Programmable Shunt Regulator

BL431R

PACKAGE OUTLINE

Plastic surface mounted package

SOT-23

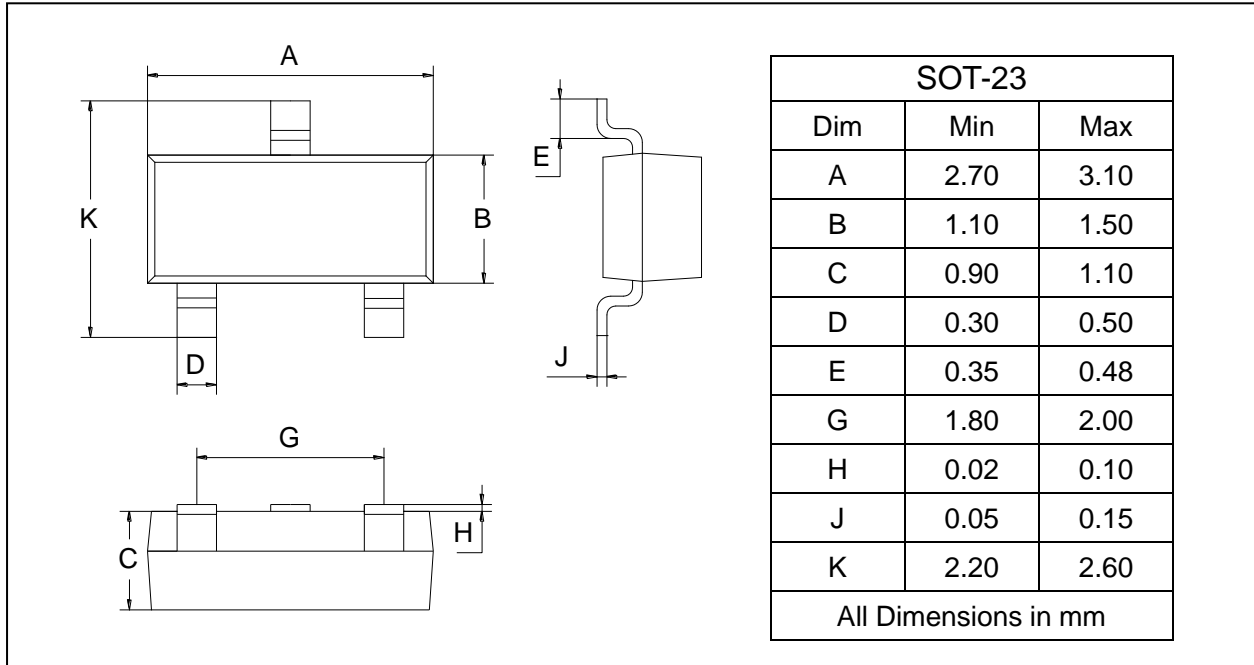

SOLDERING FOOTPRINT

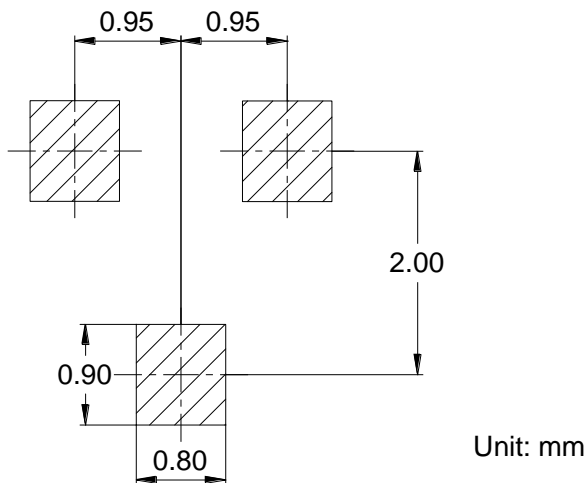

PACKAGE INFORMATION

Device	Package	Shipping
BL431R	SOT-23	3000 pcs / Tape & Reel