

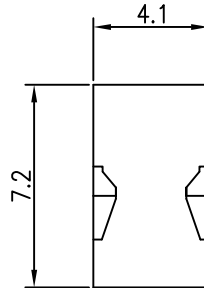

C **YI** US E182481

REV	DESCRIPTION	DATE

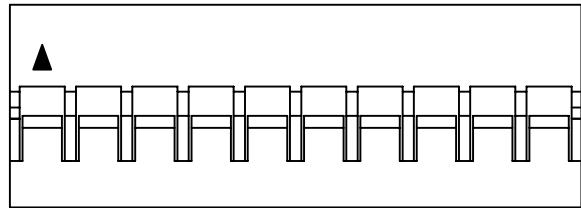
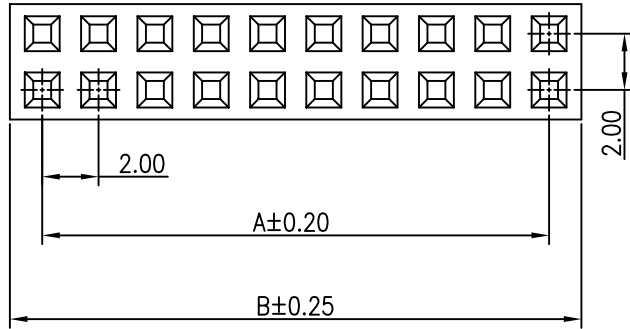

NOTES

Available in 2X2 through 2X40 Circuits
 Material: Nylon66 UL94-V0 Glass Fiber Polyester
 YY-1950-H04~YY-1950-H19
 Accepts YY-1850-T Crimp Terminal
 YY-1950-H20~YY-1950-H80
 Accepts YY-1950-T Crimp Terminal
 Mates with YY-1950-W**S or
 YY-1950-W**R Series Housing
 Color: Black

ORDERING INFORMATION

YY-1950 - H **
 1 2

- 1. H : Housing
- 2. No. of Circuits 04~80

Circuits	Dimension mm	
	A	B
2X2	2.0	4.3
2X3	4.0	6.3
A: 2.0 X (Part No. of Pin/2-1) B: 2.3 + A		
2X40	78.0	80.3

TOLERANCE					
X.	--	TITLE 2.0mm(.079") Pitch Wire to Board Housing			
X.X	±0.25				
X.XX	±0.15				
X.XXX	±0.05				
ANGULAR	--				
APPROVALS		VIEW			
DRAWN	Frank	SCALE	PART NO.	REV.	
CHECKED	Denise	F	YY-1950-H**	A0	
APPROVED	Jessica	UNIT	DWG NO.	SHEET	
	11-JUNE-2009	MM	YY-1950-H**-014	1 OF 1	





C **YI** US E182481

REV	DESCRIPTION	DATE

NOTES

Available in 2X2 through 2X40 Circuits
 Material: Nylon 66 UL94-V0 Glass Fiber Polyester
 YY-1970-H04~YY-1970-H19
 Accepts YY-1850-T Crimp Terminal
 YY-1970-H20~YY-1970-H80
 Accepts YY-1950-T Crimp Terminal
 Mates with YY-1950-W**S or
 YY-1950-W**R Series Housing
 Color: Black

ORDERING INFORMATION

YY-1970 - H **
 1 2

- 1. H : Housing
- 2. No. of Circuits 04~80

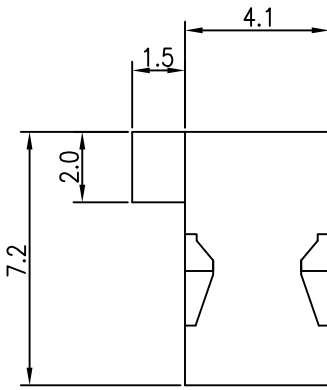
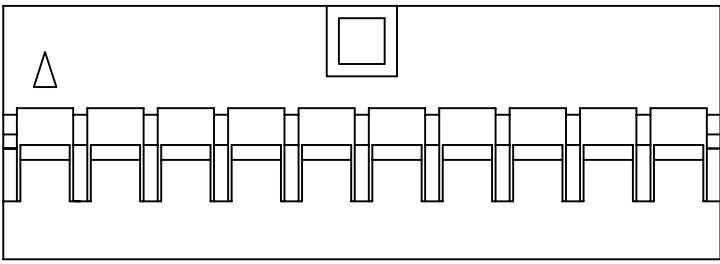
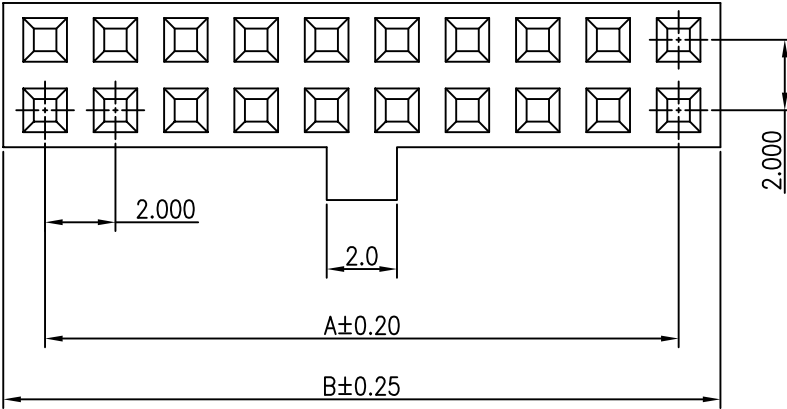

Circuits	Dimension mm		
	A	B	
2X2	2.0	4.3	
2X3	4.0	6.3	
A: 2.0 X (Part No. of Pin/2-1)			
B: 2.5 + A			
2X40	78.0	80.3	

TOLERANCE	
X.	--
X.X	±0.25
X.XX	±0.15
X.XXX	±0.05
ANGULAR	--
APPROVALS	
DRAWN	Frank 19-September-2009
CHECKED	Denise 19-September-2009
APPROVED	Jessica 19-September-2009

Young Yak Enterprise Co., Ltd.

TITLE: 2.0mm(.079") Pitch Wire to Board Housing

VIEW	SCALE	PART NO.	REV.
	5:1	YY-1970-H**	A0
UNIT	SIZE	DWG NO.	SHEET
MM	A4	YY-1970-H**-014	1 OF 1





C **YI** US E182481

REV	DESCRIPTION	DATE

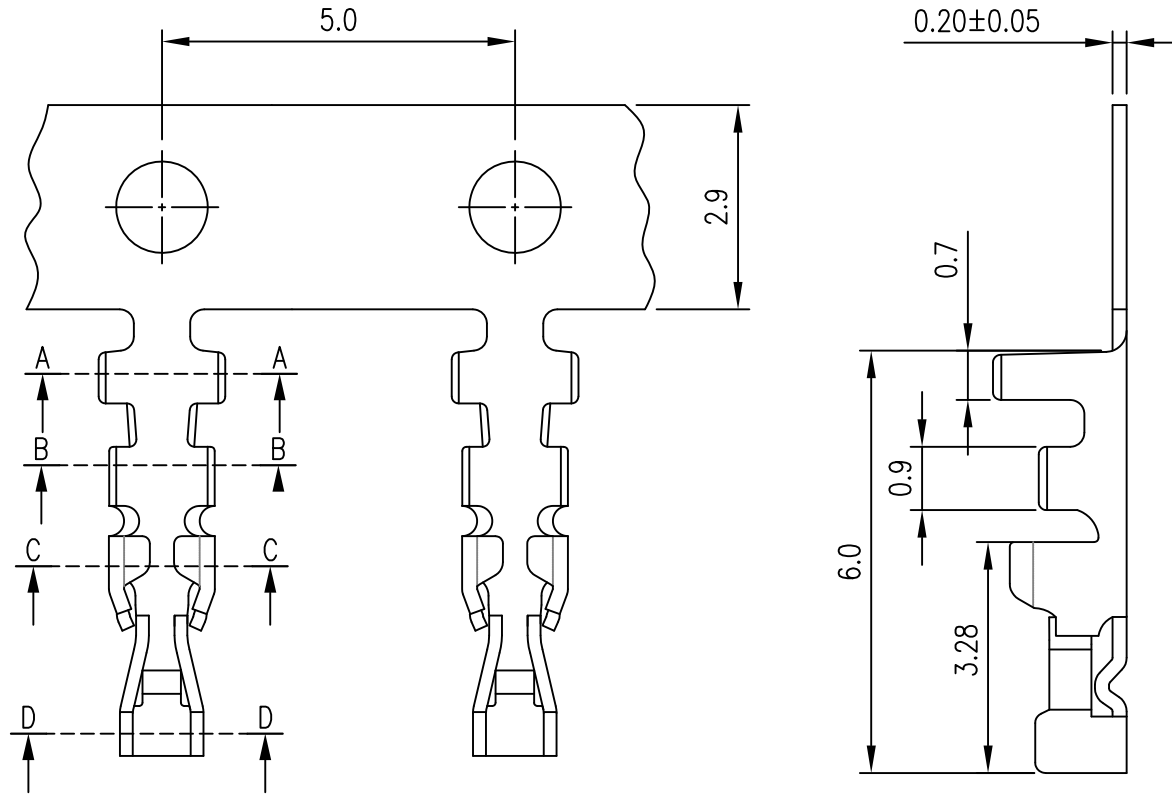

NOTES

Used in YY-1950-H &
 YY-1850-H Series Housing
 Accepts AWG #26~30 Wire Range
 Insulation O.D.= 1.35 mm(max)
 Material : Brass
 Finish : Gold-Plated
 Qty/Reel : 15,000 PCS
 Thickness: 0.2mm

ORDERING INFORMATION

YY-1950 - $\frac{T}{1}$ $\frac{GB}{2}$

1. T : Terminal
2. Plated
GB : Gold-Plated

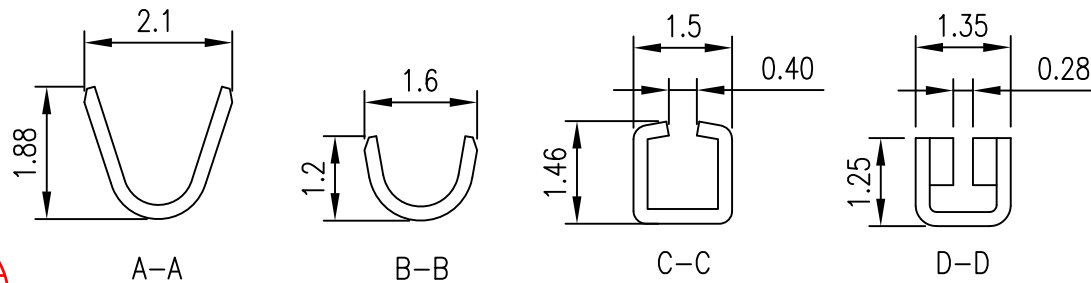

YOUNG YAK
 2009.06.12
 ISSUED

TOLERANCE		Young Yak Enterprise Co., Ltd.			
X.	--	TITLE 2.0mm(.079") Pitch Wire to Board Terminal			
X.X	±0.25				
X.XX	±0.15				
X.XXX	±0.05				
ANGULAR		--			
APPROVALS					
DRAWN	Frank	VIEW	SCALE	PART NO.	REV.
	12-JUNE-2009		F	YY-1950-TGB	A0
CHECKED	Denise	UNIT	SIZE	DWG NO.	SHEET
	12-JUNE-2009	MM	A4	YY-1950-TGB-014	1 OF 1
APPROVED	Jessica				
	12-JUNE-2009				



C **YAK** US E182481

REV	DESCRIPTION	DATE

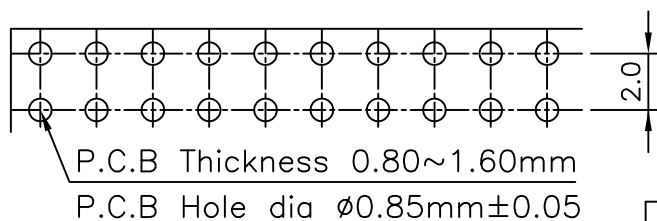
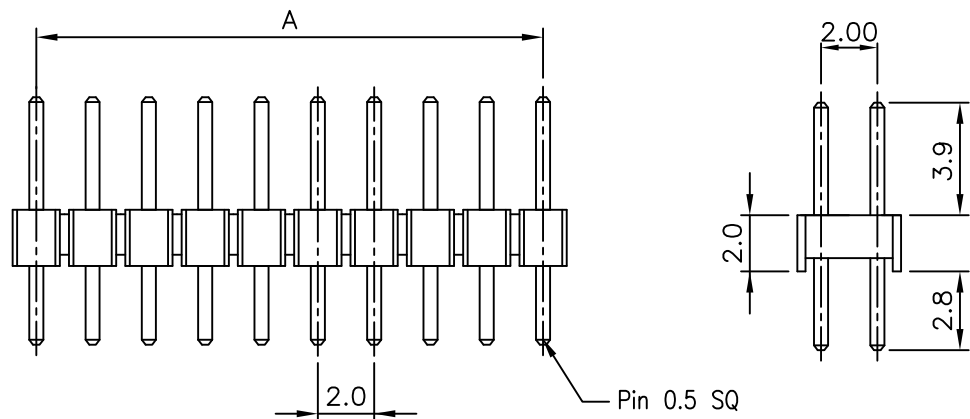
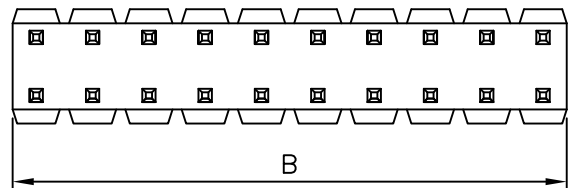

P.C.B. LAYOUT

Circuits	Dimension mm		
	A	B	
2X2	2.0	4.0	
A: 2.0 X (PART NO. OF PIN/2-1)			
B: 2.0 X (PART NO. OF PIN/2)			
2X40	78.0	80.0	

NOTES

Available in 04 through 80 Pin
 Material: P.B.T UL94-V0
 Mates with YY-1950-H Series Housing
 0.50mm(.020") Square Pin
 Pin Material: Brass/Gold-Plated

ORDERING INFORMATION

YY-1950 - W ** S G
1 2 3

- No. of Circuits 04~80
- S : Stringht
- Plated
G : Gold



TOLERANCE					
X.	--				
X.X	±0.25	TITLE 2.0mm(.079") Pitch Wire to Board Header			
X.XX	±0.15				
X.XXX	±0.08	APPROVALS			
ANGULAR	--				
DRAWN	Frank	VIEW	SCALE	PART NO.	REV.
14-September-2009			F	YY-1950-W**SG	A0
CHECKED	Denise	UNIT	SIZE	DWG NO.	SHEET
14-September-2009		MM	A4	YY-1950-W**SG-153	1 OF 1
APPROVED	Jessica				
14-September-2009					



C **YAK** US E182481

REV	DESCRIPTION	DATE

NOTES

Available in 04 through 80 Pin
 Material: P.B.T UL94-V0
 Mates with YY-1950-H Series Housing
 0.50mm(.020") Square Pin
 Pin Material: Brass/Gold-Plated

ORDERING INFORMATION

YY-1950 - W ** R G
1 2 3

- No. of Circuits 04~80
- R : Right Angle
- Plated
G : Gold

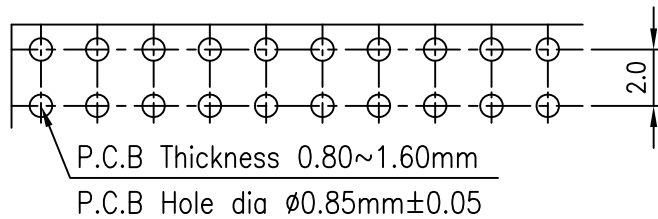
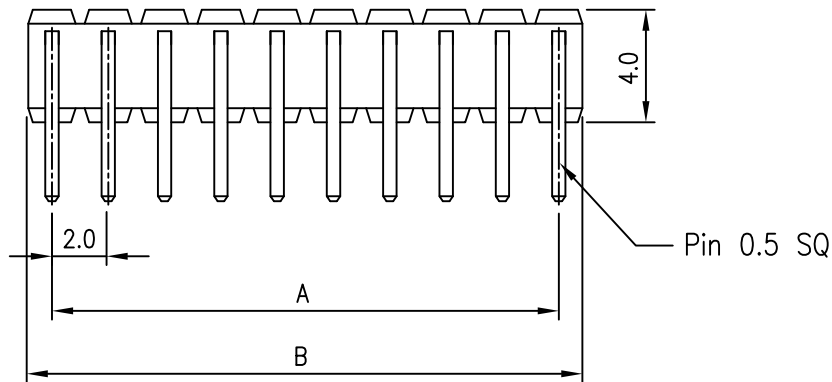
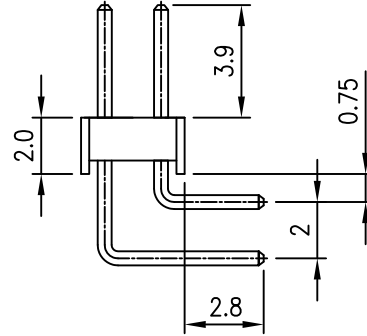
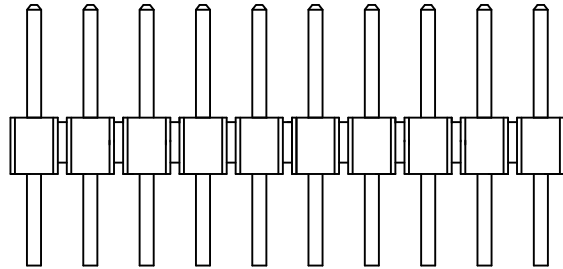

P.C.B. LAYOUT

Circuits	Dimension mm		
	A	B	
2X2	2.0	4.0	
A: 2.0 X (PART NO. OF PIN/2-1)			
B: 2.0 X (PART NO. OF PIN/2)			
2X40	78.0	80.0	

TOLERANCE				
X.	--	Young Yak Enterprise Co., Ltd. TITLE: 2.0mm(.079") Pitch Wire to Board Header		
X.X	±0.20			
X.XX	±0.10			
X.XXX	±0.05			
ANGULAR	--			
APPROVALS				
DRAWN	Frank	VIEW	SCALE	PART NO.
14-September-2009			F	YY-1950-W**RG
CHECKED	Denise	UNIT	SIZE	DWG NO.
14-September-2009		MM	A4	YY-1950-W**RG-153
APPROVED	Jessica			REV.
14-September-2009				A0
				SHEET
				1 OF 1

YOUNG YAK
 2009.09.14
 ISSUED



C **YI** US E182481

REV	DESCRIPTION	DATE

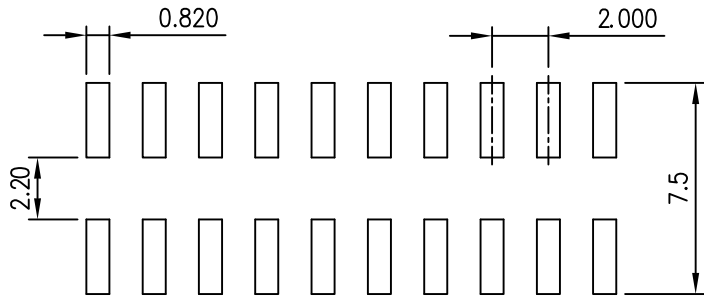
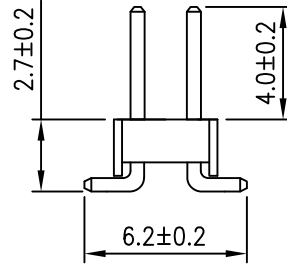
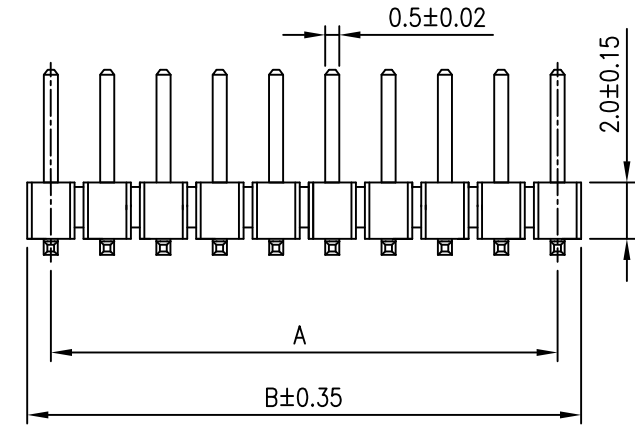
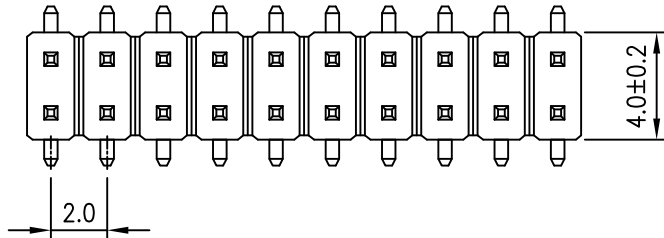

P.C.B.Layout

NOTES

Available in 04 through 80 Circuits
 Material: Nylon 6T UL94-V0
 Accepts YY-1950-H Series Housing
 0.5mm(.019") Square Pin
 Pin Material:Brass/Gold-Plated

ORDERING INFORMATION

YY-1950 - S ** S G
 1 2 3 4

- 1. S : SMT
- 2. No. of Circuits 02~80
- 3. S : Stright
- 4. Plated
- G : Gold

Circuits	Dimension mm		
	A	B	
2X2	2.0	4.0	
A: 2.0 X (PART NO. OF PIN/2-1)			
B: 2.0 X (PART NO. OF PIN/2)			
2X40	78.0	80.0	

TOLERANCE					
X.	--	Young Yak Enterprise Co., Ltd. TITLE: 2.0mm(.079") Pitch Wire to Board Header			
X.X	±0.20				
X.XX	±0.10				
X.XXX	±0.05				
ANGULAR	--				
APPROVALS					
DRAWN	Frank	VIEW	SCALE	PART NO.	REV.
	14-September-2009		F	YY-1950-S**SG	A0
CHECKED	Denise	UNIT	SIZE	DWG NO.	SHEET
	14-September-2009	MM	A4	YY-1950-S**SG-153	1 OF 1
APPROVED	Jessica				
	14-September-2009				

