

**GENERAL PURPOSE
SMD PNP TRANSISTORS**

ELECTRICAL SPECIFICATIONS

TYPE	PACKAGE	RATINGS			hFE		V _{CE(sat)}		f _T	PINOUT
		V _{CEO} V	V _{CBO} V	I _C mA	min./max. at I _C /V _{CE} mA/V		max. at I _C /I _B V mA/mA		typ MHz	
PNP										
BC869	SOT-89	20	25	1000	85/375	500/1	0.50	100/100	60	F
BCP69	SOT-223	20	25	1000	85/375	500/1	0.50	1000/100	60	R
BCX18	SOT-23	25	—	500	100/600	100/1	0.62	500/50	100	F
BC808-16	SOT-23	25	30	500	100/250	100/1	0.70	500/50	100	F
BC808-25	SOT-23	25	30	500	160/400	100/1	0.7	500/500	100	F
BC808-40	SOT-23	25	30	500	250/600	100/1	0.7	500/500	100	F
BC858A	SOT-23	30	30	100	125/250	2/5	0.30	10/0.5	150	F
BC858B	SOT-23	30	30	100	220/475	2/5	0.3	10/0.5	150	F
BC858C	SOT-23	30	30	100	420/800	2/5	0.3	10/0.5	150	F
BCV62	SOT-143	30	30	100	100/800	2/5	0.30	10/0.5	150	G
BCW29	SOT-23	32	32	100	120/260	2/5	0.30	10/0.5	150	F
BCW30	SOT-23	32	32	100	215/500	2/5	0.30	10/0.5	150	F
BCW61A	SOT-23	32	32	200	120/200	2/5	0.25	10/0.5	180	F
BCW61B	SOT-23	32	32	200	180/310	2/5	0.25	10/0.5	180	F
BCW61C	SOT-23	32	32	200	250/460	2/5	0.25	10/0.5	180	F
BCW61D	SOT-23	32	32	200	380/630	2/5	0.25	10/0.5	180	F
PMBTA70	SOT-23	40	40	100	40/100	5/10	0.25	10/1	>125	F
PMBT3906	SOT-23	40	40	200	100/300	10/1	0.25	10/1	>250	F
PMBT4403	SOT-23	40	40	600	100/300	150/2	0.40	150/5	>200	F
PXT3906	SOT-89	40	40	200	100/300	10/1	0.25	10/1	>250	F
PXT4403	SOT-89	40	40	600	100/300	150/2	0.4	150/15	>200	F
PMBT2907	SOT-23	40	60	600	100/300	150/10	0.4	150/15	>200	F
BCP51	SOT-223	45	45	1000	40/250	150/2	0.50	500/50	50	R
BCX17	SOT-23	45	—	500	100/600	100/1	0.62	500/50	100	F
BCX51	SOT-89	45	45	1000	40/250	150/2	0.50	500/50	50	F
BCX71G	SOT-23	45	45	200	120/220	2/5	0.25	10/0.5	180	F
BCX71H	SOT-23	45	45	200	180/310	2/5	0.25	10/0.5	180	F
BCX71J	SOT-23	45	45	200	250/460	2/5	0.25	10/0.5	180	F
BCX71K	SOT-23	45	45	200	380/630	2/5	0.25	10/0.5	180	F
BC807-16	SOT-23	45	50	500	100/250	100/1	0.70	500/50	100	F
BC807-25	SOT-23	45	50	500	160/400	100/1	0.7	500/50	100	F
BC807-40	SOT-23	45	50	500	250/600	100/1	0.7	500/50	100	F
BC857A	SOT-23	45	50	100	125/250	2/5	0.30	10/0.5	150	F
BC857B	SOT-23	45	50	100	220/475	2/5	0.3	10/0.5	150	F
BC857C	SOT-23	45	50	100	420/800	2/5	0.3	10/0.5	150	F
BCW69	SOT-23	45	50	100	120/260	2/5	0.30	10/0.5	150	F
BCW70	SOT-23	45	50	100	215/500	2/5	0.30	10/0.5	150	F
BCP52	SOT-223	60	60	1000	40/250	150/2	0.50	500/50	50	R
BCX52	SOT-89	60	60	1000	40/250	150/2	0.50	500/50	50	F
PMBTA55	SOT-23	60	60	500	50/-	100/1	0.25	100/10	> 50	F
PMBT2907A	SOT-23	60	60	600	100/300	150/10	0.4	150/15	>200	F
PXT2907A	SOT-89	60	60	600	100/300	150/10	0.4	150/15	>200	F
PZT2907A	SOT-223	60	60	600	100/300	150/10	0.4	150/15	>200	R
BCW89	SOT-23	60	80	100	120/260	2/5	0.30	10/0.5	150	F
BC856A	SOT-23	65	80	100	220/475	2/5	0.3	10/0.5	150	F
BC856B	SOT-23	65	80	100	125/250	2/5	0.30	10/0.5	150	F
PMBTA56	SOT-23	80	80	500	50/-	100/1	0.25	100/10	50	F
BCP53	SOT-223	80	100	1000	40/250	150/2	0.50	500/50	50	R
BCX53	SOT-89	80	100	1000	40/250	150/2	0.50	500/50	50	F

GENERAL PURPOSE SMD PNP TRANSISTORS

PINOUT DIAGRAMS

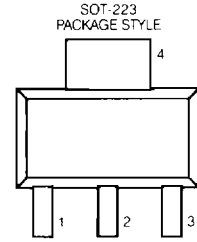
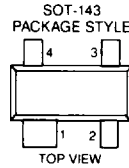
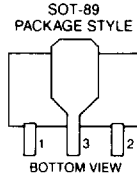
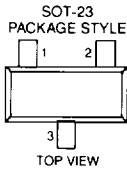

PINOUT F: SOT-23
PINOUT F: SOT-89
PINOUT G: SOT-143
PINOUT R: SOT-223

PIN 1	PIN 2	PIN 3	PIN 4
E	B	C	—
E	B	C	—
B,C ₂	C ₁	E ₁	E ₂
B	C	E	C

MARKING CODES

Type No.	Code	Type No.	Code	Type No.	Code	Type No.	Code
BC807-16	5A	BC858C	3L	BCW69	H1	PMBT2907A	2F
BC807-25	5B	BC869	CEC	BCW70	H2	PMBT3906	2A
BC807-40	5C	BCP51	*	BCW89	H3	PMBT4403	2T
BC808-16	5E	BCP52	*	BCX17	T1	PMBTA55	2H
BC808-25	5F	BCP53	*	BCX18	T2	PMBTA56	2G
BC808-40	5G	BCP69	*	BCX51	AA	PMBTA70	2C
BC856A	3A	BCV62	C91	BCX52	AE	PXT2907A	2F
BC856B	3B	BCW29	C1	BCX53	AH	PXT3906	2A
BC857A	3E	BCW30	C2	BCX71G	BG	PXT4403	2T
BC857B	3F	BCW61A	BA	BCX71H	BH	PZT2907A	*
BC857C	3G	BCW61B	BB	BCX71J	BJ		
BC858A	3J	BCW61C	BC	BCX71K	BK		
BC858B	3K	BCW61D	BD	PMBT2907	2B		

*See individual device data sheet

TAPE AND REEL SPECIFICATIONS

(Dimensions in mm)

SM Package	Devices per reel	Reel Size (in)	Tape Width (mm)	Ordering Suffix
SOT-23	3K	7	8	TRL
	10K	13	8	TRL 13
SOT-89	1K	7	12	TRL
	4K	13	12	TRL 13
SOT-143	3K	7	8	TRL
	10K	13	8	TRL 13
SOT-223	1K	7	12	TRL
	4K	13	12	TRL 13

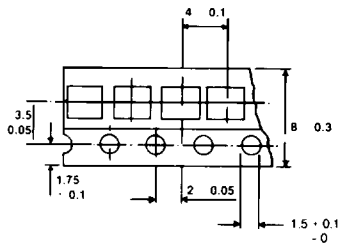
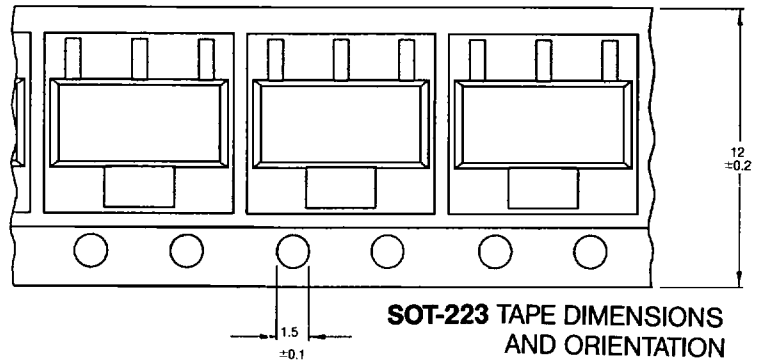

**SOT-23 and SOT-143
TAPE DIMENSIONS**

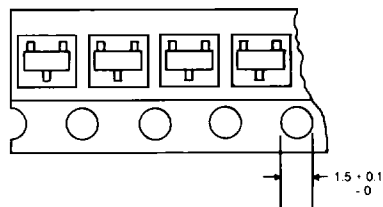

**SOT-23
ORIENTATION**

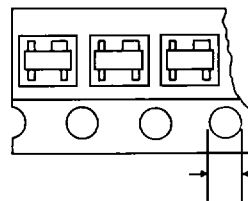

**SOT-143
ORIENTATION**

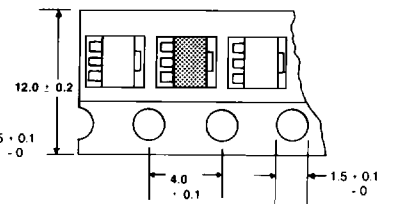

**SOT-89
TAPE DIMENSIONS
AND ORIENTATION**