

Medium Power Transistor (25V, 1.2A)

2SD2537 / 2SD2171S

●Features

- 1) High DC current gain.
- 2) High emitter-base voltage. ($V_{CE0}=12V$ Min.)
- 3) Low $V_{CE(sat)}$. (Max. 0.3V at $I_C/I_E=500/10mA$)

●Packaging specifications and h_{FE}

Type	2SD2537	2SD2171S
Package	MPT3	SPT
h_{FE}	VW	V
Marking	DV*	—
Code	T100	TP
Basic ordering unit (pieces)	1000	5000

* Denotes h_{FE}

●Electrical characteristics ($T_a=25^\circ C$)

Parameter	Symbol	Min.	Typ.	Max.	Unit	Conditions
Collector-base breakdown voltage	BV_{CBO}	30	—	—	V	$I_C=10 \mu A$
Collector-emitter breakdown voltage	BV_{CEO}	25	—	—	V	$I_C=1mA$
Emitter-base breakdown voltage	BV_{EBO}	12	—	—	V	$I_E=10 \mu A$
Collector cutoff current	I_{CBO}	—	—	0.3	μA	$V_{CE}=30V$
Emitter cutoff current	I_{EBO}	—	—	0.3	μA	$V_{EB}=12V$
Collector-emitter saturation voltage	$V_{CE(sat)}$	—	—	0.3	V	$I_C/I_E=500mA/10mA$ *
DC current transfer ratio	h_{FE}	820	—	2700	—	$V_{CE}/I_C=5V/0.5A$
		820	—	1800	—	
Transition frequency	f_T	—	200	—	MHz	$V_{CE}=10V, I_E=-50mA, f=100MHz$ *
Output capacitance	C_{ob}	—	20	—	pF	$V_{CE}=10V, I_E=0A, f=1MHz$

* Measured using pulse current.

(94L-1061-D212)

●Absolute maximum ratings ($T_a=25^\circ C$)

Parameter	Symbol	Limits	Unit
Collector-base voltage	V_{CBO}	30	V
Collector-emitter voltage	V_{CEO}	25	V
Emitter-base voltage	V_{EBO}	12	V
Collector current	I_C	1.2	A (DC)
		2	A (Pulse) *1
Collector power dissipation	P_C	2	W *2
		0.3	
Junction temperature	T_J	150	$^\circ C$
Storage temperature	T_{stg}	-55~150	$^\circ C$

*1 Single pulse $P_w=100ms$ *2 On 40 x 40 x 0.7 mm ceramic board.

General Purpose Transistor (50V, 0.15A)

2SD2351 / 2SD2226K / 2SD2227S

●Features

- 1) High DC current gain.
- 2) High emitter-base voltage. ($V_{CE0}=12V$ Min.)
- 3) Low $V_{CE(sat)}$. (Typ. 0.3V at $I_C/I_E=50/5mA$)

●Packaging specifications and h_{FE}

Type	2SD2351	2SD2226K	2SD2227S
Package	UMT3	SMT3	SPT
h_{FE}	VW	VW	W
Marking	BJ *	BJ *	—
Code	T106	T146	TP
Basic ordering unit (pieces)	3000	3000	5000

* Denotes h_{FE}

●Absolute maximum ratings ($T_a=25^\circ C$)

Parameter	Symbol	Limits	Unit
Collector-base voltage	V_{CBO}	60	V
Collector-emitter voltage	V_{CEO}	50	V
Emitter-base voltage	V_{EBO}	12	V
Collector current	I_C	0.15	A (DC)
		0.2	A (Pulse) *
Collector power dissipation	P_C	0.2	W
		0.3	
Junction temperature	T_J	150	$^\circ C$
Storage temperature	T_{stg}	-55~150	$^\circ C$

* Single pulse $P_w=100ms$

●Electrical characteristics ($T_a=25^\circ C$)

Parameter	Symbol	Min.	Typ.	Max.	Unit	Conditions
Collector-base breakdown voltage	BV_{CBO}	60	—	—	V	$I_C=10 \mu A$
Collector-emitter breakdown voltage	BV_{CEO}	50	—	—	V	$I_C=1mA$
Emitter-base breakdown voltage	BV_{EBO}	12	—	—	V	$I_E=10 \mu A$
Collector cutoff current	I_{CBO}	—	—	0.3	μA	$V_{CE}=50V$
Emitter cutoff current	I_{EBO}	—	—	0.3	μA	$V_{EB}=12V$
Collector-emitter saturation voltage	$V_{CE(sat)}$	—	—	0.3	V	$I_C/I_E=50mA/5mA$ *
DC current transfer ratio	h_{FE}	560	—	2700	—	$V_{CE}/I_C=5V/1mA$ *
		1200	—	2700	—	$V_{CE}/I_C=5V/1mA$ *
Transition frequency	f_T	—	250	—	MHz	$V_{CE}=5V, I_E=-10mA, f=100MHz$ *
Output capacitance	C_{ob}	—	3.5	—	pF	$V_{CE}=5V, I_E=0A, f=1MHz$

* Measured using pulse current.

(94S-374-D215)

Packages

ROHM has been manufacturing transistors since 1975. In the development of products, we constantly strive to anticipate the needs of our customers. Regarding packages, the demands of the market for compactness, low power consumption, low power dissipation and automatic mounting support are becoming ever greater, and we are strengthening our product development system to meet these needs.

●Types and features of surface-mount packages

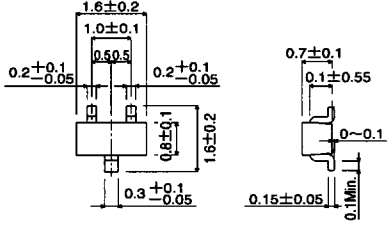
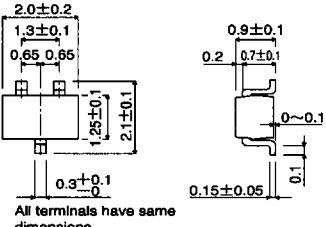
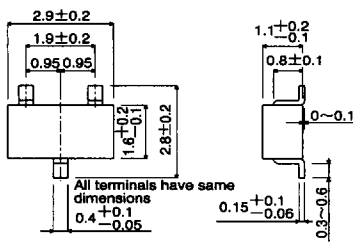
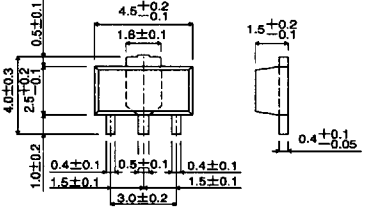
Type	External dimensions (Units : mm)	Features
EMT3 SC-75A type	 <p>Technical drawing of the EMT3 SC-75A package. The top view shows a rectangular package with dimensions: width 1.6 ± 0.2 mm, length 1.0 ± 0.1 mm, and a central feature of 0.50 ± 0.05 mm. Terminal spacing is 0.2 ± 0.1 mm. The side view shows a height of 0.7 ± 0.1 mm, a lead width of 0.1 ± 0.55 mm, a lead thickness of 0.15 ± 0.05 mm, and a lead length of 0.3 ± 0.1 mm. A note indicates a minimum lead length of 0.1 mm.</p>	<p>A more compact version of the UMT3 (SC-70), the EMT3 is the world's smallest transistor with a mold size of 1.6×0.8 mm. The mounting area is approximately 60% of the UMT3 and 30% of the SMT3, making it ideal for ultra-high density mounting. Mounting is possible with the same type of automatic mounting machine as the UMT3.</p>
UMT3 SC-70 type	 <p>Technical drawing of the UMT3 SC-70 package. The top view shows a rectangular package with dimensions: width 2.0 ± 0.2 mm, length 1.3 ± 0.1 mm, and terminal spacing of 0.65 mm. The side view shows a height of 0.9 ± 0.1 mm, a lead width of 0.7 ± 0.1 mm, a lead thickness of 0.15 ± 0.05 mm, and a lead length of 0.3 ± 0.1 mm. A note states: "All terminals have same dimensions".</p>	<p>The UMT3 is a smaller version of the SMT3 (SC-59). The mounting area is approximately 60% of the SMT3, making it optimum for high density mounting. The taping size is the same as the SMT3, allowing use of conventional automatic mounting machines. Electrical characteristics and reliability are the same as the SMT3.</p>
SMT3 SC-59 type	 <p>Technical drawing of the SMT3 SC-59 package. The top view shows a rectangular package with dimensions: width 2.9 ± 0.2 mm, length 1.9 ± 0.2 mm, and terminal spacing of 0.95 mm. The side view shows a height of 1.1 ± 0.2 mm, a lead width of 0.8 ± 0.1 mm, a lead thickness of 0.15 ± 0.1 mm, and a lead length of 0.4 ± 0.1 mm. A note states: "All terminals have same dimensions".</p>	<p>The SMT3 is a compact package suitable for small electronic devices and hybrid IC applications. With proven performance, this is one of the most basic small packages. With the exception of P_c (collector power dissipation), electrical characteristics are similar to leaded packages. Reliability is on the same level as the TO-92.</p>
MPT3 SC-62 type	 <p>Technical drawing of the MPT3 SC-62 package. The top view shows a rectangular package with dimensions: width 4.6 ± 0.2 mm, length 1.8 ± 0.1 mm, and terminal spacing of 0.5 mm. The side view shows a height of 1.5 ± 0.2 mm, a lead width of 0.4 ± 0.1 mm, and a lead thickness of 0.4 ± 0.1 mm. A note states: "All terminals have same dimensions".</p>	<p>By itself the MPT3 has a P_c of 0.5 W ($T_a = 25^\circ\text{C}$), but when used on a $40 \times 40 \times 0.7$ mm ceramic board, $P_c = 2$ W ($T_c = 25^\circ\text{C}$), allowing high power to be obtained with a small package. The flat package makes it suitable for applications requiring compactness such as hybrid ICs. Available on tape for automatic mounting.</p>

Type	External dimensions (Units : mm)	Features
<p>CPT 3 SC-63 type</p>	<p>Technical drawing of CPT 3 SC-63 type transistor. Top view dimensions: 6.5±0.2, 5.1±0.2, 0.9, 0.65±0.1, 2.3±0.2, 2.3±0.2. Side view dimensions: 2.3±0.2, 0.5±0.1, 1.5, 2.5, 9.5±0.5, 0.55±0.1, 1.0±0.2. Lead diameter: C0.5. Lead length: 5.5+0.3/-0.1, 1.5±0.3, 0.75, 0.9.</p>	<p>By itself the CPT3 has a P_c of 1 W ($T_a = 25^\circ\text{C}$), but a large P_c of several watts can be obtained with an appropriate mounting surface. At the same time the CPT3 is compact, making it suitable for high density mounting and hybrid ICs. Available on tape for automatic mounting. For vertical high density mounting, the leaded CPT (SC-64) type with the same mold size is also available.</p>
<p>PSD3</p>	<p>Technical drawing of PSD3 transistor. Top view dimensions: 10.1±0.3, 13.1±0.5, 3.2, 2.54, 5.08, 0.78, 1.24, 8.6±0.2. Side view dimensions: 4.5±0.2, 1.3, 0~0.3, 0.4, 1.3, 0.5Min.</p>	<p>The PSD3 is a TO-220 class surface-mount package. A high P_c can be obtained with an appropriate mounting surface. Surface mounting allows a high vertical density, enabling the design of slim and compact devices. The PSD3 is available on tape for automatic mounting, and it helps improve mounting efficiency and reduce mounting cost.</p>
<p>SMT5 SC-74A type</p>	<p>Technical drawing of SMT5 SC-74A type transistor. Top view dimensions: 2.9±0.2, 1.9±0.2, 0.95, 0.95, 1.6±0.2, 1.6±0.1, 2.8±0.2, 0.3±0.1, 0.05. Side view dimensions: 1.1±0.2, 0.1, 0.8±0.1, 0~0.1, 0.15±0.1, 0.06, 0.3~0.6.</p> <p>All terminals have same dimensions</p>	<p>The SMT5 consists of two connected transistors or digital transistors in an SMT3 (SC-59) package. The mounting area can be reduced by 50% compared to the SMT3 and the internal circuitry is complete, making this package ideal for high density mounting at half the assembly cost.</p>
<p>SMT6 SC-74 type</p>	<p>Technical drawing of SMT6 SC-74 type transistor. Top view dimensions: 2.9±0.2, 1.9±0.2, 0.95, 0.95, 1.6±0.2, 1.6±0.1, 2.8±0.2, 0.3±0.1, 0.05. Side view dimensions: 1.1±0.2, 0.1, 0.8±0.1, 0~0.1, 0.15±0.1, 0.06, 0.3~0.6.</p>	<p>The SMT6 consists of two independent transistors or two independent digital transistors in an SMT3 (SC-59) package. The mounting area and mounting cost can be reduced by 50% compared to the SMT3, and the two transistors are independent to allow free configuration of a high density circuit.</p>

EXPLANATION

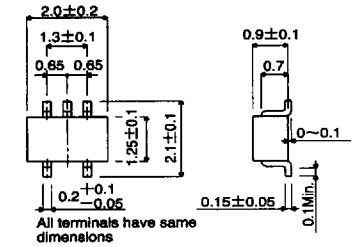
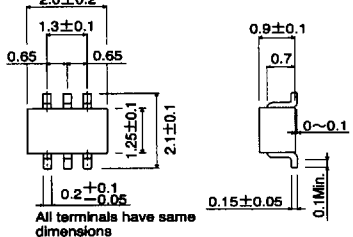
Type	External dimensions (Units : mm)	Features
<p>UMT5 SC-88A type</p>	 <p>All terminals have same dimensions</p>	<p>The UMT5 consists of two connected transistors or digital transistors in a UMT3 (SC-70) package. The mounting area can be reduced by 50% compared to the UMT3 and the internal circuitry is completed, making this package ideal for high density mounting at half the assembly cost.</p>
<p>UMT6 SC-88 type</p>	 <p>All terminals have same dimensions</p>	<p>The UMT6 consists of two independent transistors or two independent digital transistors in a UMT (SC-70) package. The mounting area and mounting cost can be reduced by 50% compared to the UMT3, and the two transistors are independent to allow free configuration of a high density circuit.</p>

●Types and features of leaded packages

Type	External dimensions (Units : mm)	Features
<p>SPT (SC-72 type)</p>		<p>The SPT is a smaller version of the conventional TO-92 type. The body size (3×4×2 mm³) has been reduced to 1/4 that of the TO-92 (5×5×4 mm³). The SPT is available on tape for automatic insertion, and less space is occupied on the printed circuit board than the TO-92. Reliability is the same as the TO-92.</p>
<p>FTR</p>		<p>SIL type with a height of 3.4 mm and a lead pitch of 2.54 mm.</p>
<p>FTL</p>		<p>The FTL is a radial taping version of the highly popular FTR. This enables automatic high-density mounting with a radial insertion machine.</p>
<p>ATR (SC-71 type)</p>		<p>SC-71 type with a height of 4.4 mm and a P_c=1W type.</p>

EXPLANATION

Type	External dimensions (Units : mm)	Features
<p>ATV</p>		<p>The ATV is a radial tapping version of the highly popular ATR. This enables automatic high-density mounting with a radial insertion machine.</p>
<p>TO-92 (SC-43 type)</p>		<p>The SC-43 is for general purpose small signals.</p>
<p>TO-126FP</p>		<p>The TO-126FP is an isolation type package based on a TO-126 full mold. In addition to the features of the TO-126, molded heat sink fins allow easy isolation of the heat sink.</p>
<p>TO-220FP (SC-67 type)</p>		<p>The TO-220FP is an isolation type package based on a TO-220 full mold. In addition to the features of the TO-126 and TO-220, molded heat sink fins allow easy isolation of the heat sink.</p>

7828999 0016713 7T7

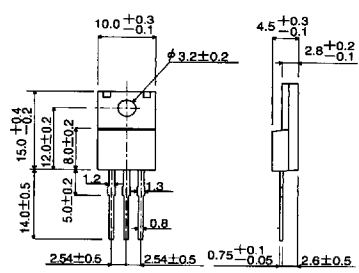
Type	External dimensions (Units : mm)	Features
TO-220FN	 <p>Technical drawing of the TO-220FN transistor showing front and side views with dimensions in millimeters:</p> <ul style="list-style-type: none"> Top width: $10.0^{+0.3}_{-0.1}$ Top diameter: $\phi 3.2 \pm 0.2$ Top thickness: $4.5^{+0.3}_{-0.1}$ Top hole diameter: $2.8^{+0.2}_{-0.1}$ Front view height: $15.0^{+0.4}_{-0.2}$ Front view hole diameter: $12.0^{+0.2}_{-0.2}$ Front view hole offset: $8.0^{+0.2}_{-0.2}$ Front view hole diameter: $5.0^{+0.2}_{-0.2}$ Front view hole offset: 1.2 Front view hole diameter: 1.3 Front view hole diameter: 0.8 Bottom hole diameter: 2.54 ± 0.5 Bottom hole diameter: 2.54 ± 0.5 Bottom hole diameter: $0.75^{+0.1}_{-0.05}$ Bottom hole diameter: 2.6 ± 0.5 	<p>The TO-220FN features the same performance as the TO-220FP with approximately 2 mm less height, allowing the design of slimmer devices. Furthermore, the elimination of support pins in the fin (collector electrode) solves short-circuiting problems with neighboring components and the chassis.</p> <p>To make the height to the installation hole the same as the TO-220FP, it can be replaced as is from the TO-220FP.</p>

EXPLANATION

■ 7828999 0016714 633 ■