

# UTC U584/57 LINEAR INTEGRATED CIRCUIT

## 8A,5A,3A LOW DROPOUT POSITIVE REGULATORS ADJUSTABLE AND FIXED

### DESCRIPTION

The UTC U584/585/587 voltage regulators are monolithic integrated circuits, designed for use in applications requiring a well regulated positive output voltage with +5V input. The output voltage can be adjustable from 3.8 V down to 1.3V.

### FEATURES

- \*Low dropout performance.
- \*Adjustable output down to 1.3V.
- \*Line regulation typically below 0.1%.
- \*Load regulation typically below 0.1%.
- \*Output current can be up to 8 A for UTC U584.
- \*Three-terminal adjustable or fixed 3.3V.

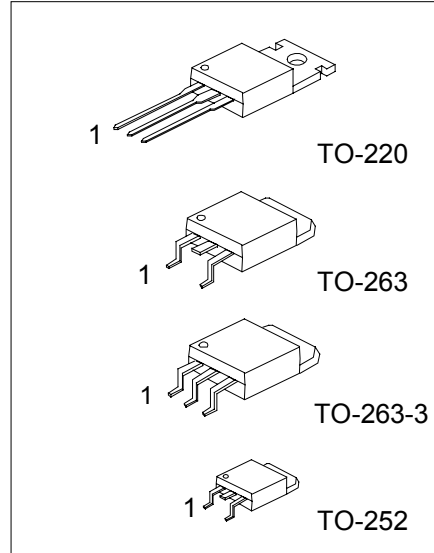

1: ADJ/GND 2: OUTPUT 3: INPUT

### BLOCK DIAGRAM

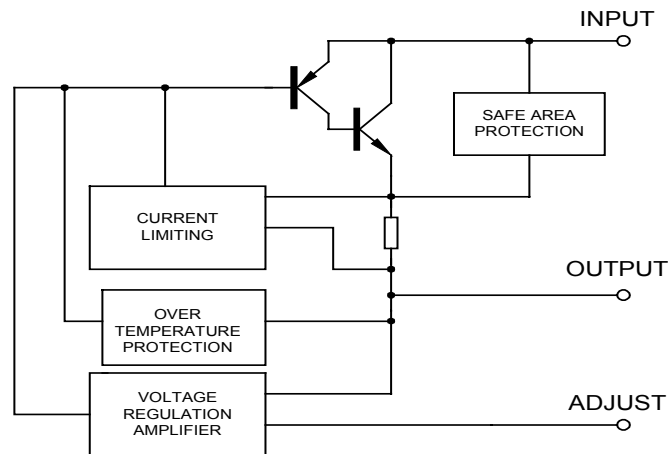

# UTC U584/5/7 LINEAR INTEGRATED CIRCUIT

## ABSOLUTE MAXIMUM RATINGS

PARAMETER	SYMBOL	VALUE	UNIT
Input Voltage	V <sub>IN</sub>	7	V
Power Dissipation	P <sub>D</sub>	Internally Limited	W
Operating Junction Temperature Range	T <sub>J</sub>	0 to 125	°C
Storage Temperature	T <sub>STG</sub>	-65 to 150	°C
Lead Temperature (Soldering 10 Sec.)	T <sub>LEAD</sub>	300	°C

## ELECTRICAL CHARACTERISTICS

PARAMETER	TEST CONDITIONS	MIN	TYP	MAX	UNIT
Reference Voltage U584 U585 U587	1.3V ≤ (V <sub>IN</sub> -V <sub>OUT</sub> ) ≤ 3V, 10mA ≤ I <sub>OUT</sub> ≤ 8A 1.3V ≤ (V <sub>IN</sub> -V <sub>OUT</sub> ) ≤ 3V, 10mA ≤ I <sub>OUT</sub> ≤ 5A, 1.3V ≤ (V <sub>IN</sub> -V <sub>OUT</sub> ) ≤ 3V, 10mA ≤ I <sub>OUT</sub> ≤ 3A	* 1.225	1.25	1.275	V
Output Voltage U584-3.3 U585-3.3 U587-3.3	4.75V ≤ V <sub>IN</sub> ≤ 6.5V, 10mA ≤ I <sub>OUT</sub> ≤ 8A 4.75V ≤ V <sub>IN</sub> ≤ 7V, 10mA ≤ I <sub>OUT</sub> ≤ 5A 4.75V ≤ V <sub>IN</sub> ≤ 7V, 10mA ≤ I <sub>OUT</sub> ≤ 3A	3.234	3.300	3.366	V
Line Regulation (Note 1.2) U584/5/7 U584/5/7-3.3	2.75V ≤ V <sub>IN</sub> ≤ 7V, I <sub>OUT</sub> = 10mA 4.75V ≤ V <sub>IN</sub> ≤ 7V, I <sub>OUT</sub> = 0mA		0.1	0.2	%
Load Regulation (Note 1, 2, 3) U584/5/7 U584/5/7-3.3	V <sub>IN</sub> -V <sub>OUT</sub> =2.5V, T <sub>J</sub> =25°C, 10mA ≤ I <sub>OUT</sub> ≤ I <sub>FULLLOAD</sub> V <sub>IN</sub> =5V, T <sub>J</sub> =25°C, 0mA ≤ I <sub>OUT</sub> ≤ I <sub>FULLLOAD</sub>	*	0.2	1.0	%
Dropout Voltage	ΔV <sub>REF</sub> =1%, I <sub>OUT</sub> = I <sub>FULLLOAD</sub> T <sub>J</sub> ≥ 25°C T <sub>J</sub> ≤ 25°C		1.2 1.2	1.3 1.35	V V
Current Limit (Note 3) U584 U585 U587	V <sub>IN</sub> -V <sub>OUT</sub> = 3 V V <sub>IN</sub> -V <sub>OUT</sub> = 3 V V <sub>IN</sub> -V <sub>OUT</sub> = 3 V	* 8.0 5.0 3.0	8.5 5.5 3.6		A
Adjust Pin Current			55	120	μA
Adjust Pin Current Change (Note 3)	1.5V ≤ (V <sub>IN</sub> -V <sub>OUT</sub> ) ≤ 3 V, 10mA ≤ I <sub>OUT</sub> ≤ I <sub>FULLLOAD</sub>		0.2	5	mA
Minimum Load Current	1.5V ≤ (V <sub>IN</sub> -V <sub>OUT</sub> ) ≤ 3V	*	2	10	mA
Quiescent Circuit Current	V <sub>IN</sub> ≤ 5V	*	8	13	mA
Ripple Rejection	f=120Hz, C <sub>OUT</sub> =25μA <sub>Tant</sub> , V <sub>IN</sub> -V <sub>OUT</sub> = 2.5V, I <sub>OUT</sub> = I <sub>FULLLOAD</sub>	60	72		dB
Temperature Stability			0.5		%
Long-Term Stability	T <sub>A</sub> =25°C, 1000Hrs		0.03	1.0	%
RMS Output Noise (% of V <sub>OUT</sub> )	T <sub>A</sub> =125°C, 10Hz ≤ f ≤ 10kHz		0.03		%
Thermal Resistance Junction to Case U584 U587				1.6 3.0	°C/W
Thermal Resistance Junction to Ambient, θ <sub>JA</sub> U585				60	°C/W
Thermal Resistance Junction to Board, θ <sub>JT</sub> U585				2.7	°C/W

# UTC U584/5/7 LINEAR INTEGRATED CIRCUIT

The \* denotes specifications which apply over the specified operating temperature range.

Note 1: Load and line regulation are measured at a constant junction temperature by low duty cycle pulse testing.

Note 2: Line and load regulation are guaranteed up to the maximum power dissipation (15W for the UTC U584, 10W for the UTC U585). Power dissipation is determined by input / output differential and the output current. Guaranteed maximum output power will not be available over the full input-output voltage range.

Note 3: I<sub>FULLLOAD</sub> is defined as the maximum value of output load current as a function of input-to-output voltage. Output current can be different for different input-to-output voltage.

## APPLICATION CIRCUIT (ADJUSTABLE)

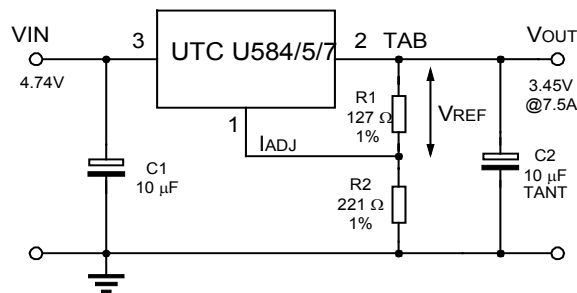

REQUIRED FOR STABILITY

$$V_{OUT} = V_{REF} \cdot (1 + R2/R1) + I_{ADJ} \cdot R2$$

## APPLICATION CIRCUIT (3.3V)

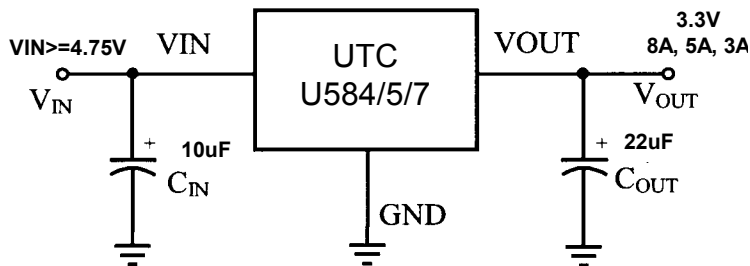

# UTC U584/57 LINEAR INTEGRATED CIRCUIT

## TYPICAL PERFORMANCE CHARACTERISTICS

**U584**

**Dropout Voltage**

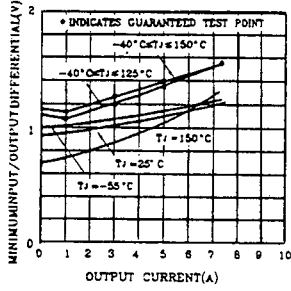

**U584**

**Short-Circuit Current**

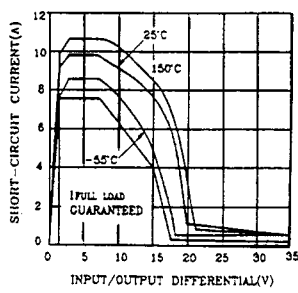

**U584**

**Load Regulation**

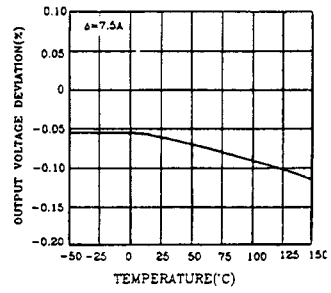

**U585**

**Dropout Voltage**

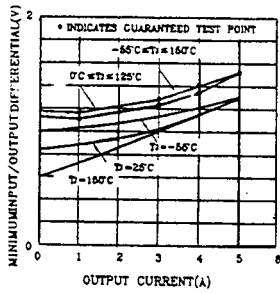

**U585**

**Short-Circuit Current**

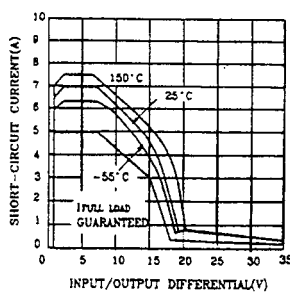

**U585**

**Load Regulation**

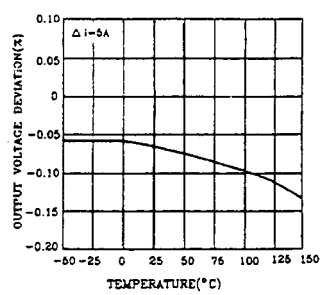

**U587**

**Dropout Voltage**

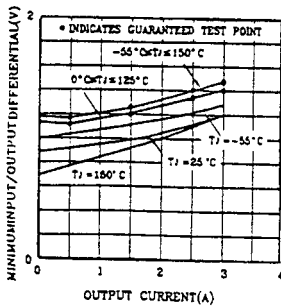

**U587**

**Short-Circuit Current**

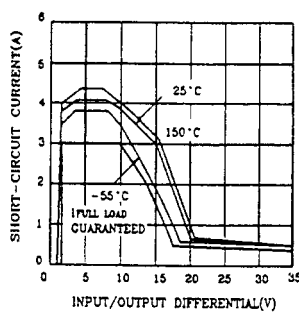

**U587**

**Load Regulation**

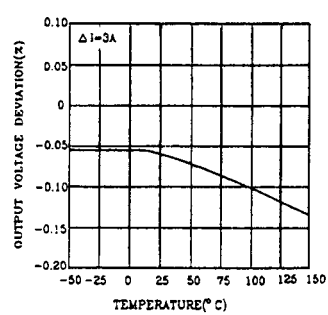

# UTC U584/5/7 LINEAR INTEGRATED CIRCUIT

**Minimum Operating Current**

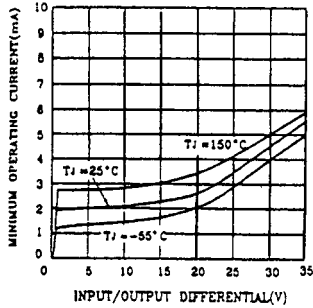

**Temperature Stability**

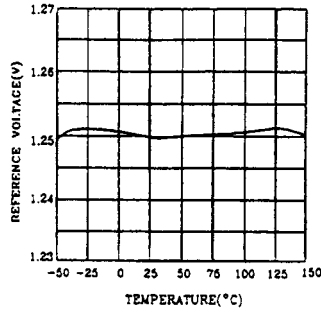

**Adjust Pin Current**

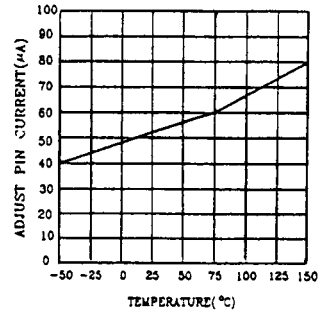

**U584**

**Ripple Rejection**

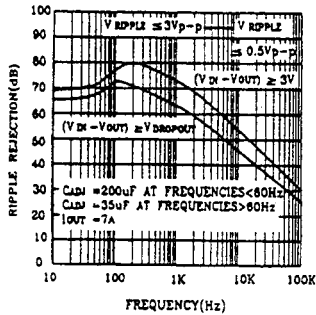

**U584**

**Ripple Rejection vs Current**

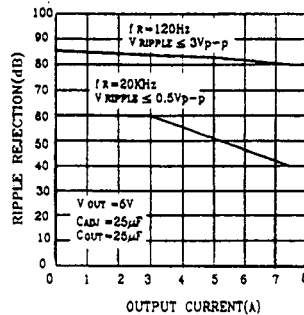

**U584**

**Maximum Power Dissipation\***

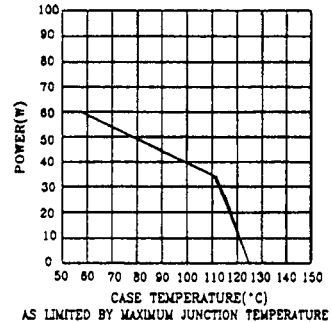

**U585**

**Ripple Rejection**

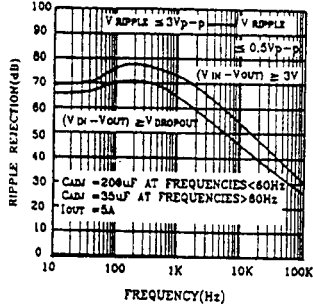

**U585**

**Ripple Rejection vs Current**

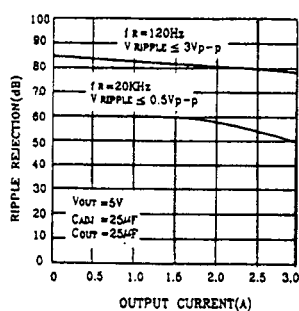

**U585**

**Maximum Power Dissipation**

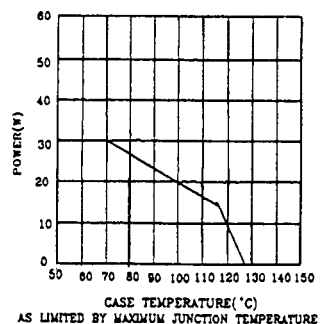

# UTC U584/57 LINEAR INTEGRATED CIRCUIT

U587

Ripple Rejection

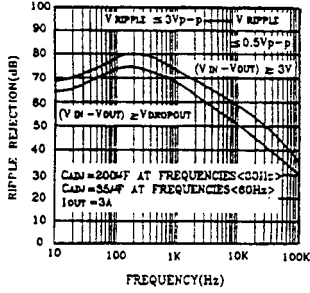

U587

Ripple Rejection vs Current

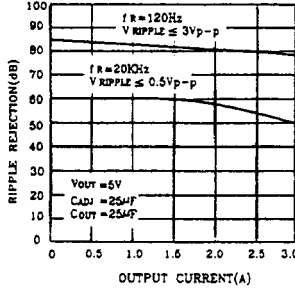

U587

Maximum Power Dissipation

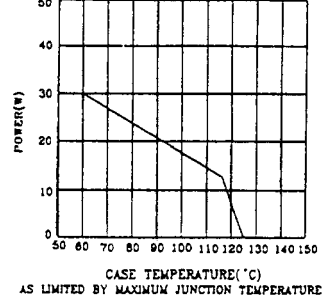

U584

Load Transient Response

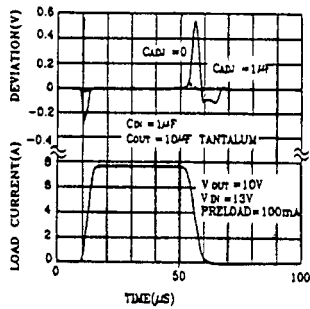

U585

Load Transient Response

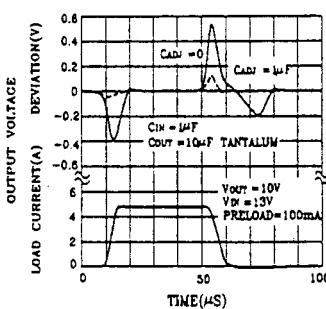

U587

Load Transient Response

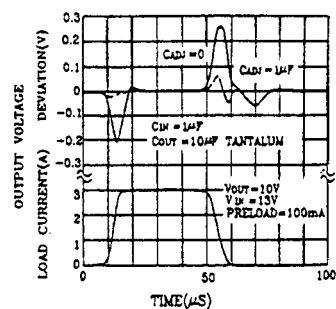

U584

Line Transient Response

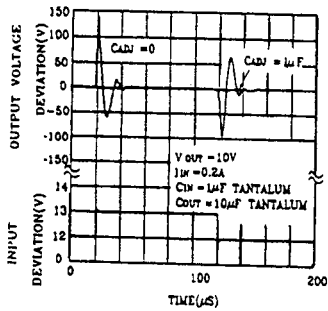

U585

Line Transient Response

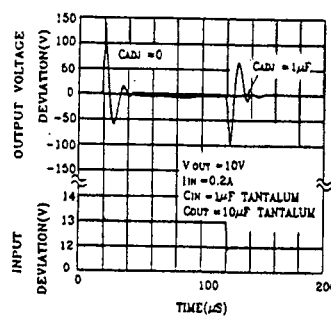

U587

Line Transient Response

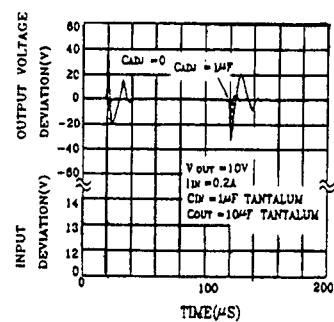

# UTC U584/57    LINEAR INTEGRATED CIRCUIT

UTC assumes no responsibility for equipment failures that result from using products at values that exceed, even momentarily, rated values (such as maximum ratings, operating condition ranges, or other parameters) listed in products specifications of any and all UTC products described or contained herein. UTC products are not designed for use in life support appliances, devices or systems where malfunction of these products can be reasonably expected to result in personal injury. Reproduction in whole or in part is prohibited without the prior written consent of the copyright owner. The information presented in this document does not form part of any quotation or contract, is believed to be accurate and reliable and may be changed without notice.