

D-Subminiature Commercial Metal Shell

.109" (2.77mm) Density Dip Solder Right Angle Grounded D*L Series

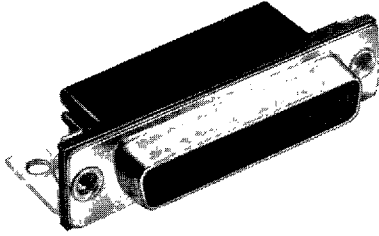

Socket

Features

- Provides ground continuity from cable to PC board
- Available in 5 connector sizes: 9, 15, 19, 25 and 37, with right angle dip solder tails, in socket style only
- Available with tail lengths of .125" (3.18mm) or .156" (3.96mm) in three footprint styles
- Available in 3 footprints ("J" dimension): .318" (8.08mm), .478" (12.14mm), .590" (14.99mm) as measured from front face of mounting flange to first row of contacts
- Intermateable with all D-Subminiature connectors of comparable pin count and complying dimensionally with MIL-C-24308

Performance Data

Materials

Insulation Material: Black UL 94V-0 rated glass-filled nylon

Contact Material: Phosphor bronze

Contact Plating: Gold flash over nickel in contact area; tin/lead over nickel on tails; for 30 μinch select gold plating consult factory

Shell/Bracket Material: Steel

Shell/Bracket Plating: Tin

Electrical Characteristics

Withstanding Voltage: 1000 VAC rms (@ sea level)

Current Rating: 5 Amps

Contact Resistance: 2.7 Milliohms maximum

Insulation Resistance: 5000 Megohms minimum

Mechanical Characteristics

Individual Contact Insertion and Separation Force: 0.7 oz. minimum; 12 oz. maximum

Environmental Characteristics

Shock: Exceeds requirements of MIL-STD-202D, Method 213, Condition G

Operating Temperature: - 55°C to + 125°C

Vibration: Exceeds requirements of MIL-STD-202D, Method 204, Condition D

Humidity: Exceeds requirements of MIL-STD-202D, Method 106

Ordering Information

D	B	L	-	25	S	-	1	L
Series Prefix		Series Designator			Contact Style			
D-Subminiature		L = Grounded			S = Socket			
	Shell Size			No. of Contacts		Footprint Dim. "J"		
	E = 09			09		1 = 318" (8.08mm)		
	A = 15			15		2 = 478" (12.14mm)		
	B = 25			25		3 = 590" (14.99mm)		
	C = 37			37				
						Contact Tail Length (Optional)		
						No Entry = 125" (3.18mm)		
						L = 156" (3.96mm)		

**D-Subminiature
Commercial
Metal Shell**

**.109" (2.77mm) Density
Dip Solder Right Angle
Grounded**

CINCH

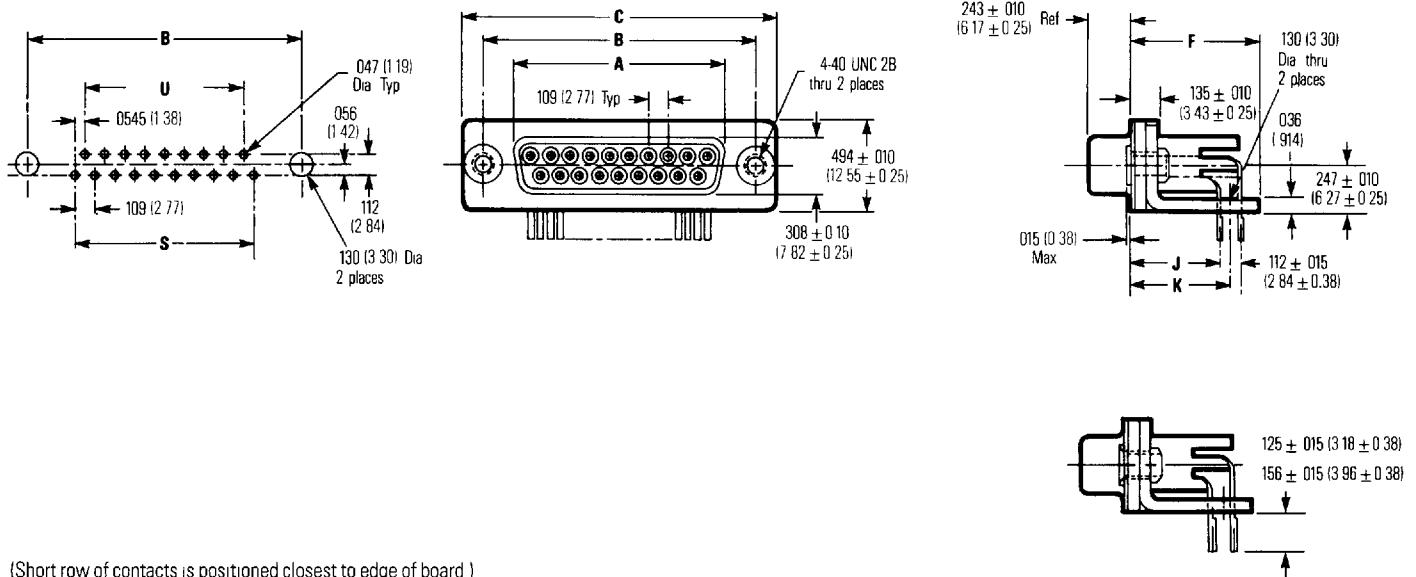

(Short row of contacts is positioned closest to edge of board.)

Dimensions

No. of Contacts	Tail Length		A ± .010 (.25)		B ± .005 (.13)		C ± .015 (.38)		F ± 0.010 (.25)		J* ± .015 (.38)		K ± .015 (.38)		S	U		
	in	mm	in	mm	in	mm	in	mm	in	mm	in	mm	in	mm		in	mm	
9	.125	3.18	.640	16.26	.984	24.99	1.213	30.81	.544	13.81	.318	8.08	.374	9.50	.436	11.07	.327	8.31
9	.125	3.18	.640	16.26	.984	24.99	1.213	30.81	.704	17.88	.478	12.14	.534	13.56	.436	11.07	.327	8.31
9	.125	3.18	.640	16.26	.984	24.99	1.213	30.81	.816	20.72	.590	14.99	.646	16.41	.436	11.07	.327	8.31
9	.156	3.96	.640	16.26	.984	24.99	1.213	30.81	.544	13.81	.318	8.08	.374	9.50	.436	11.07	.327	8.31
9	.156	3.96	.640	16.26	.984	24.99	1.213	30.81	.704	17.88	.478	12.14	.534	13.56	.436	11.07	.327	8.31
9	.156	3.96	.640	16.26	.984	24.99	1.213	30.81	.816	20.72	.590	14.99	.646	16.41	.436	11.07	.327	8.31
15	.125	3.18	.968	24.59	1.312	33.32	1.541	39.14	.544	13.81	.318	8.08	.374	9.50	.763	19.38	.654	16.61
15	.125	3.18	.968	24.59	1.312	33.32	1.541	39.14	.704	17.88	.478	12.14	.534	13.56	.763	19.38	.654	16.61
15	.125	3.18	.968	24.59	1.312	33.32	1.541	39.14	.816	20.72	.590	14.99	.646	16.41	.763	19.38	.654	16.61
15	.156	3.96	.968	24.59	1.312	33.32	1.541	39.14	.544	13.81	.318	8.08	.374	9.50	.763	19.38	.654	16.61
15	.156	3.96	.968	24.59	1.312	33.32	1.541	39.14	.704	17.88	.478	12.14	.534	13.56	.763	19.38	.654	16.61
15	.156	3.96	.968	24.59	1.312	33.32	1.541	39.14	.816	20.72	.590	14.99	.646	16.41	.763	19.38	.654	16.61
25	.125	3.18	1.508	38.30	1.852	47.04	2.088	53.04	.544	13.81	.318	8.08	.374	9.50	1.308	33.22	1.199	30.45
25	.125	3.18	1.508	38.30	1.852	47.04	2.088	53.04	.704	17.88	.478	12.14	.534	13.56	1.308	33.22	1.199	30.45
25	.125	3.18	1.508	38.30	1.852	47.04	2.088	53.04	.816	20.72	.590	14.99	.646	16.41	1.308	33.22	1.199	30.45
25	.156	3.96	1.508	38.30	1.852	47.04	2.088	53.04	.544	13.81	.318	8.08	.374	9.50	1.308	33.22	1.199	30.45
25	.156	3.96	1.508	38.30	1.852	47.04	2.088	53.04	.704	17.88	.478	12.14	.534	13.56	1.308	33.22	1.199	30.45
25	.156	3.96	1.508	38.30	1.852	47.04	2.088	53.04	.816	20.72	.590	14.99	.646	16.41	1.308	33.22	1.199	30.45
37	.125	3.18	2.156	54.76	2.500	63.50	2.729	69.32	.544	13.81	.318	8.08	.374	9.50	1.962	49.83	1.853	47.07
37	.125	3.18	2.156	54.76	2.500	63.50	2.729	69.32	.704	17.88	.478	12.14	.534	13.56	1.962	49.83	1.853	47.07
37	.125	3.18	2.156	54.76	2.500	63.50	2.729	69.32	.816	20.72	.590	14.99	.646	16.41	1.962	49.83	1.853	47.07
37	.156	3.96	2.156	54.76	2.500	63.50	2.729	69.32	.544	13.81	.318	8.08	.374	9.50	1.962	49.83	1.853	47.07
37	.156	3.96	2.156	54.76	2.500	63.50	2.729	69.32	.704	17.88	.478	12.14	.534	13.56	1.962	49.83	1.853	47.07
37	.156	3.96	2.156	54.76	2.500	63.50	2.729	69.32	.816	20.72	.590	14.99	.646	16.41	1.962	49.83	1.853	47.07

*J = Footprint

Standard Density Plug Inserts

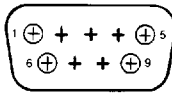

Shell Size E
(9 Position)

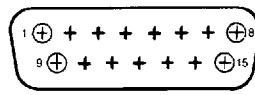

Shell Size A
(15 Position)

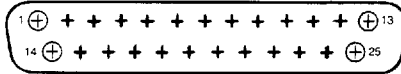

Shell Size B
(25 Position)

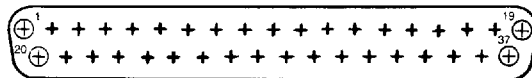

Shell Size C
(37 Position)

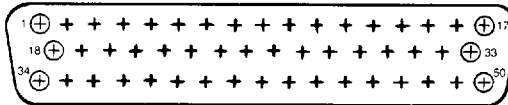

Shell Size D
(50 Position)

HTD 1.5 Density Plug Inserts

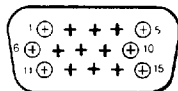

Shell Size E
(15 Position)

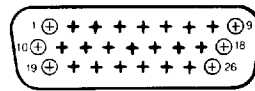

Shell Size A
(26 Position)

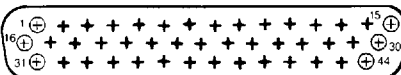

Shell Size B
(44 Position)

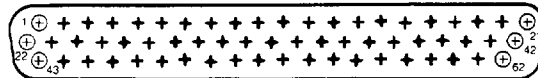

Shell Size C
(62 Position)

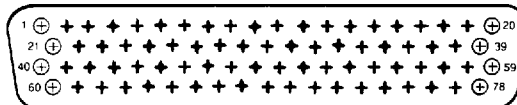

Shell Size D
(78 Position)

NOTE: Mating face of plug is shown, receptacle is mirror image.

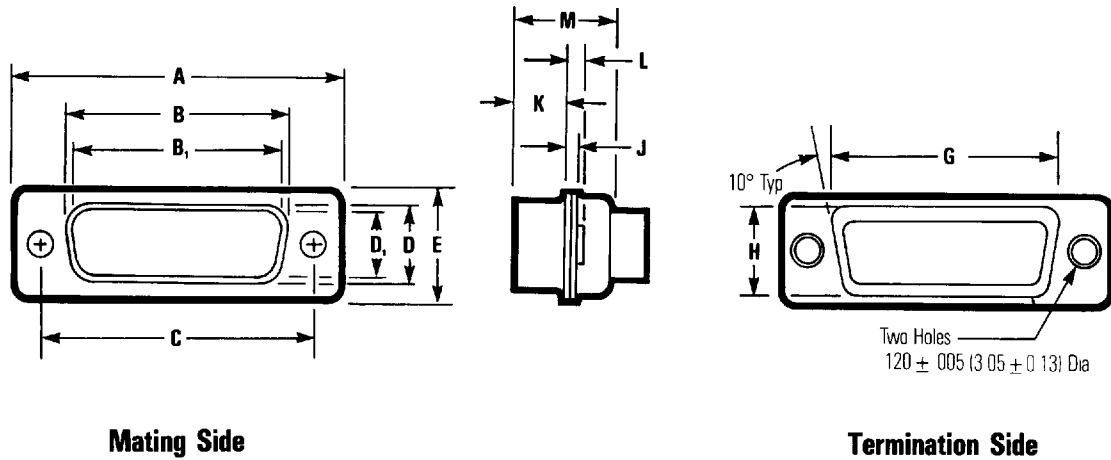

Dimensions

Shell Size	Connector Type	A ± .015" (0.38mm)		B ± .010" (0.25mm)		B ₁ ± .005" (0.13mm)		C ± .005" (0.13mm)		D ± .010" (0.25mm)		D ₁ ± .010" (0.25mm)		E ± .015" (0.38mm)	
		in	mm	in	mm	in	mm	in	mm	in	mm	in	mm	in	mm
E	Plug	1.213	30.81	—	—	.666	16.90	.0984	24.99	—	8.40	.329	—	.494	12.55
	Socket	1.213	30.81	.640	16.26	—	—	.0984	24.99	.308	—	—	.782	.494	12.55
A	Plug	1.541	39.14	—	—	.994	25.30	1.312	33.32	—	8.40	.329	—	.494	12.55
	Socket	1.541	39.14	.968	24.59	—	—	1.312	33.32	.308	—	—	.782	.494	12.55
B	Plug	2.088	53.04	—	—	1.534	39.00	1.852	47.04	—	8.40	.329	—	.494	12.55
	Socket	2.088	53.04	1.508	38.30	—	—	1.852	47.04	.308	—	—	.782	.494	12.55
C	Plug	2.729	69.32	—	—	2.182	55.40	2.500	63.50	—	8.40	.329	—	.494	12.55
	Socket	2.729	69.32	2.156	54.76	—	—	2.500	63.50	.308	—	—	.782	.494	12.55
D	Plug	2.635	66.93	—	—	2.079	52.80	2.406	61.11	—	11.07	.436	—	.605	15.37
	Socket	2.635	66.93	2.062	52.34	—	—	2.406	61.11	.420	—	—	10.67	.605	15.37

Shell Size	Connector Type	G ± .010" (0.25mm)		H ± .010" (0.25mm)		J ± .010" (0.25mm)		K ± .010" (0.25mm)		L ± .010" (0.25mm)		M ± .010" (0.25mm)	
		in	mm	in	mm	in	mm	in	mm	in	mm	in	mm
E	Plug	.759	19.28	.422	10.72	.030	0.76	.236	5.99	.045	1.14	.422	10.72
	Socket	.759	19.28	.422	10.72	.030	0.76	.243	6.17	.045	1.14	.429	10.92
A	Plug	1.083	27.51	.422	10.72	.030	0.76	.236	5.99	.045	1.14	.422	10.72
	Socket	1.083	27.51	.422	10.72	.030	0.76	.243	6.17	.045	1.14	.429	10.92
B	Plug	1.625	41.27	.422	10.72	.039	0.99	.231	5.87	.060	1.52	.426	10.82
	Socket	1.625	41.27	.422	10.72	.030	0.76	.243	6.17	.045	1.14	.429	10.92
C	Plug	2.272	57.71	.422	10.72	.039	0.99	.231	5.87	.060	1.52	.426	10.82
	Socket	2.272	57.71	.422	10.72	.030	0.76	.243	6.17	.045	1.14	.429	10.92
D	Plug	2.178	55.32	.534	13.56	.039	0.99	.231	5.87	.060	1.52	.426	10.82
	Socket	2.178	55.32	.534	13.56	.030	0.76	.243	6.17	.045	1.14	.429	10.92

B and D are outside dimensions for socket. B₁ and D₁ are inside dimensions for plug

Panel Mounting Specifications

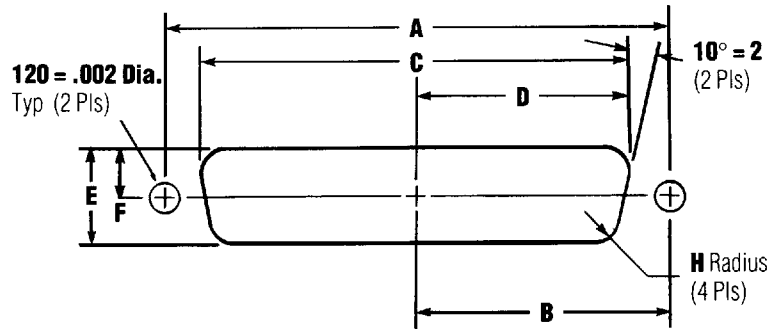

Dimensions

Shell Size	Mounting Method Front/Rear Panel	Dimensions (inches)						
		A	B	C	D	E	F	H
E	Front	0.98	0.49	0.87	0.44	0.51	0.26	0.08
	Rear	0.98	0.49	0.81	0.40	0.45	0.23	0.13
A	Front	1.31	0.66	1.10	0.60	0.51	0.26	0.08
	Rear	1.31	0.66	1.13	0.57	0.45	0.23	0.13
B	Front	1.85	0.93	1.74	0.87	0.51	0.26	0.08
	Rear	1.85	0.93	1.67	0.84	0.45	0.23	0.13
C	Front	2.50	1.25	2.39	1.20	0.51	0.26	0.08
	Rear	2.50	1.25	2.33	1.16	0.45	0.23	0.13
D	Front	2.41	1.20	2.30	1.15	0.62	0.31	0.08
	Rear	2.41	1.20	2.22	1.11	0.56	0.28	0.13

Float Bushing

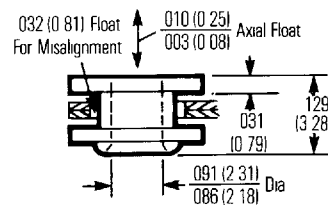

4-40 Clinch Nut

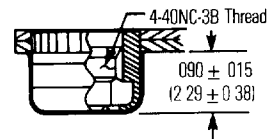

Reverse Float Bushing

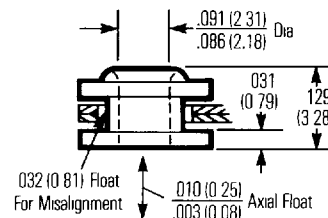

Floating Dual Bushing

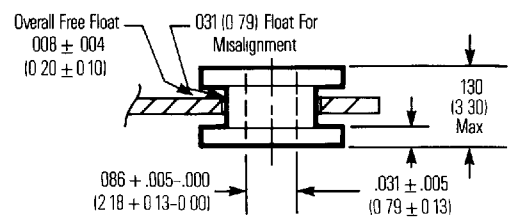

Standard Density D-Subminiature Mounting Dimensions Board Layouts Footprints (Shown from component side)

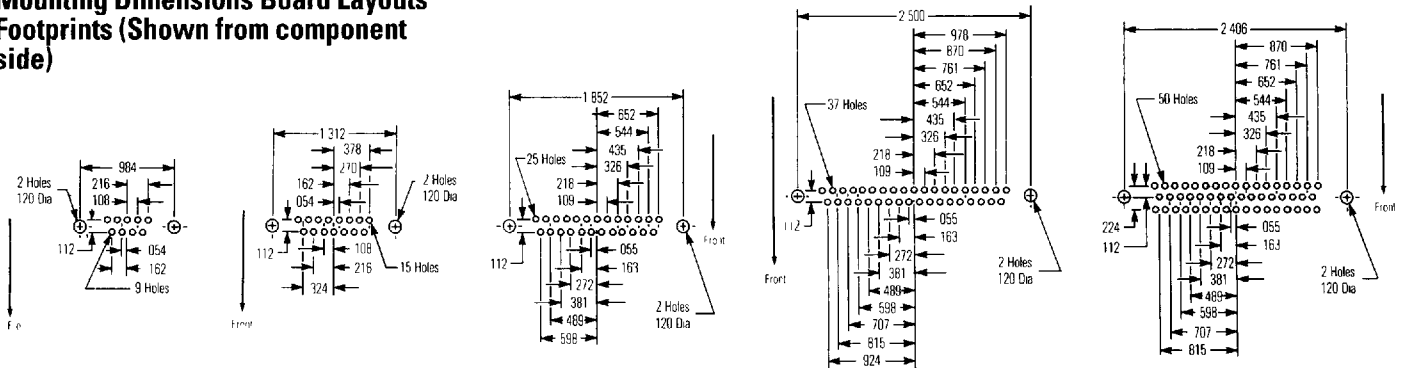

1.5 Density D-Subminiature Recommended PCB Layout For Footprint (Component Side Shown)

15 Position PCB Layout

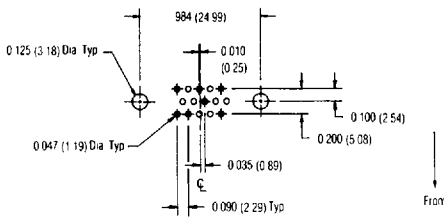

44 Position PCB Layout

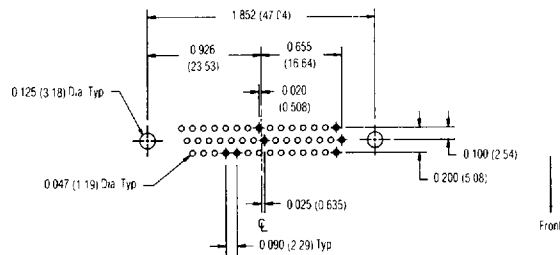

26 Position PCB Layout

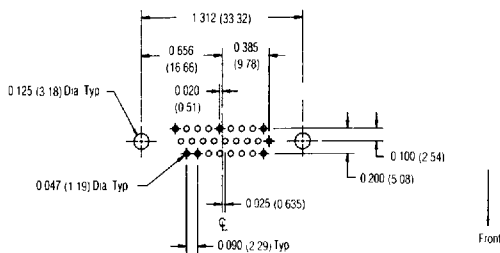

62 Position PCB Layout

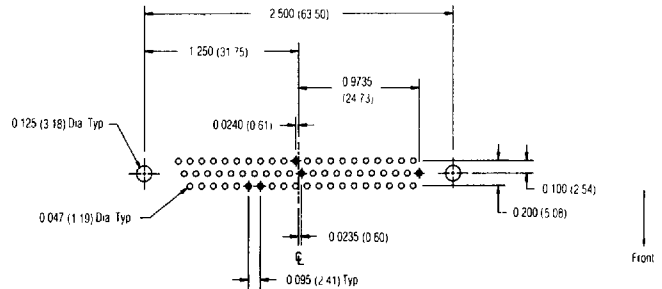

The footprints on this page are standard for all metal shell D-Subminiature Connectors.

On all right angle D-Subminiature Connectors the short row of contacts is positioned closest to the edge of the board.

PC Board Lead Hole Size

Terminal Dia.		Hole Dia.	
in	mm	in	mm
040	1.02	055	1.40
030	0.76	045	1.14
.024	0.61	039	0.99