

## UGP30A thru UGP30K

### 1. FEATURES

- \* Plastic package has Underwriters Laboratories Flammability Classification 94V-0
- \* Ideally suited for use in very high frequency switching power supplies, inverters and as free wheeling diodes
- \* Ultrafast recovery time for high efficiency
- \* Excellent high temperature switching
- \* Soft recovery characteristics
- \* Cavity-free glass passivated junction
- \* High temperature soldering guaranteed: 260°C/10 seconds, 0.375" (9.5mm) lead length, 5 lbs. (2.3kg) tension

### 2. Mechanical Data

**Case:** JEDEC DO-201AD, molded plastic over glass body

**Terminals:** Plated axial leads, solderable per MIL-STD-750, Method 2026

**Polarity:** Color band denotes cathode end

**Mounting Position:** Any

**Weight:** 0.04 oz., 1.10 g

**Handling precaution:** None

### 3. Electrical Characteristic

**Maximum Ratings & Thermal Characteristics Ratings** at 25°C ambient temperature unless otherwise specified.

Parameter Symbol	symbol	UGP 30A	UGP 30B	UGP 30D	UGP 30F	UGP 30G	UGP 30J	UGP 30K	Unit
Maximum repetitive peak reverse voltage	$V_{RRM}$	50	100	200	300	400	600	800	V
Maximum RMS voltage	$V_{RMS}$	35	70	140	210	280	420	560	V
Maximum DC blocking voltage	$V_{DC}$	50	100	200	300	400	600	800	V
Maximum average forward rectified current 0.375" (9.5mm) lead length at $T_A = 55^\circ C$	$I_{F(AV)}$	3.0							A
Peak forward surge current 8.3ms single half sine-wave superimposed on rated load (JEDEC Method)	$I_{FSM}$	125					115		A
Maximum full load reverse current, full cycle average, 0.375" (9.5mm) lead lengths at $T_A = 55^\circ C$	$I_{R(AV)}$	100							$\mu A$
Typical thermal resistance (Note 2)	$R_{\theta JA}$	20							$^\circ C/W$
Operating junction and storage temperature range	$T_J, T_{STG}$	-50 to +150							$^\circ C$

**Electrical Characteristics Ratings** at 25°C ambient temperature unless otherwise specified.

Parameter Symbol	symbol	UGP 30A	UGP 30B	UGP 30D	UGP 30F	UGP 30G	UGP 30J	UGP 30K	Unit
Maximum instantaneous forward voltage at 2.0A	$V_F$	0.95			1.25		1.70	2.20	V
Maximum DC reverse current $T_A = 25^\circ C$ at rated DC blocking voltage $T_A = 125^\circ C$	$I_R$	10 200							$\mu A$
Typical reverse recovery time (Note 1)	$t_{rr}$	35							ns
Typical junction capacitance at 4.0V, 1MHz	$C_J$	35							PF

NOTES:

1.  $I_F = 0.5A, I_R = 1.0A, I_{RR} = 0.25A$

2. Thermal resistance from junction to ambient at 0.375" (9.5mm) lead length, P.C.B. mounted

### Glass Passivated Junction Ultra Fast Rectifiers

Reverse Voltage 50 to 800V  
Forward Current 3.0A

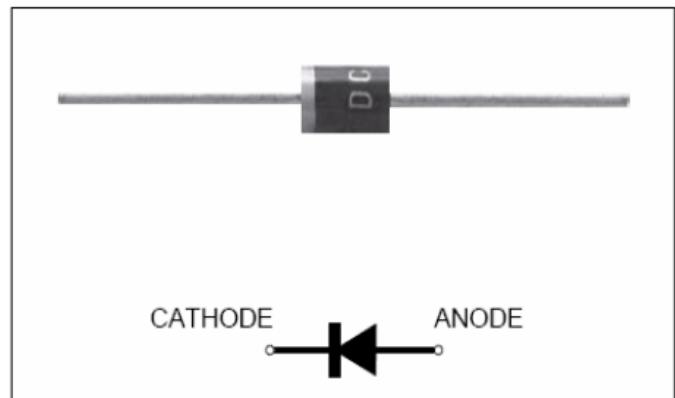

We declare that the material of product compliance with RoHS requirements.

### 4. Ratings and Characteristic Curves (TA = 25°C unless otherwise noted)

FIG.1 - FORWARD CURRENT DERATING CURVE

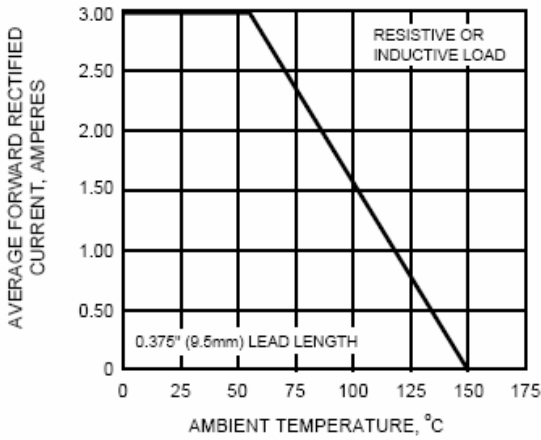

FIG.2 - MAXIMUM NON-REPETITIVE PEAK FORWARD SURGE CURRENT

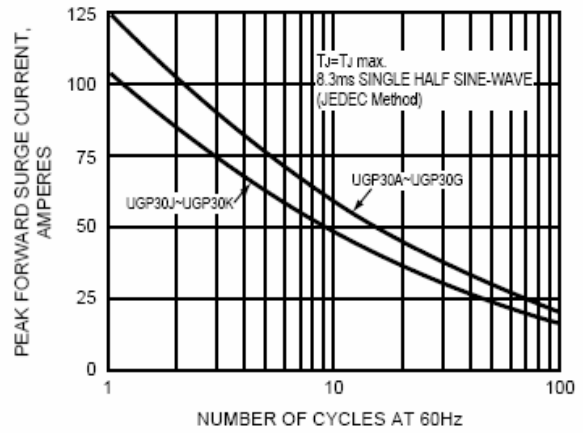

FIG.3 - TYPICAL INSTANTANEOUS FORWARD CHARACTERISTICS

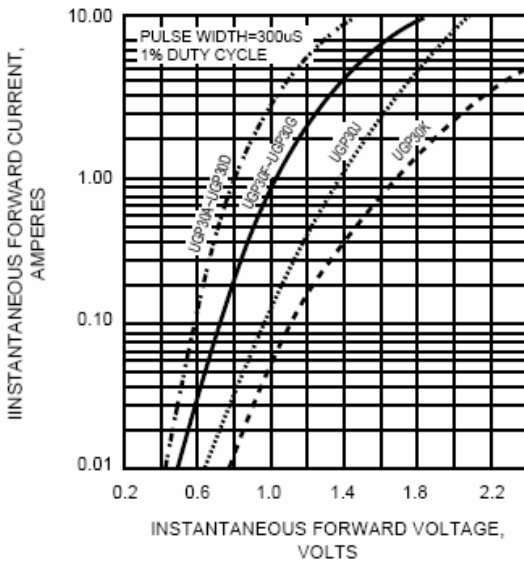

FIG.4 - TYPICAL REVERSE CHARACTERISTICS

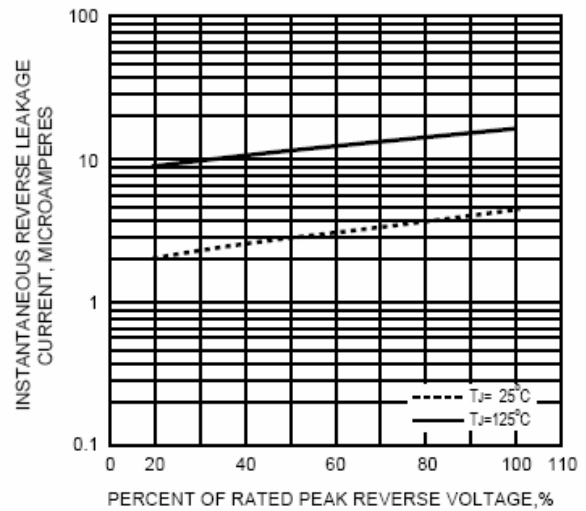
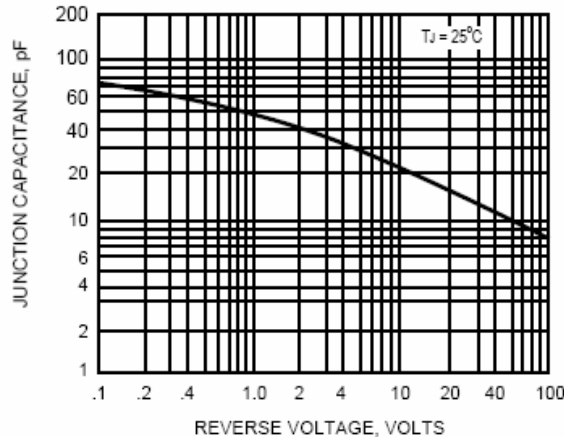
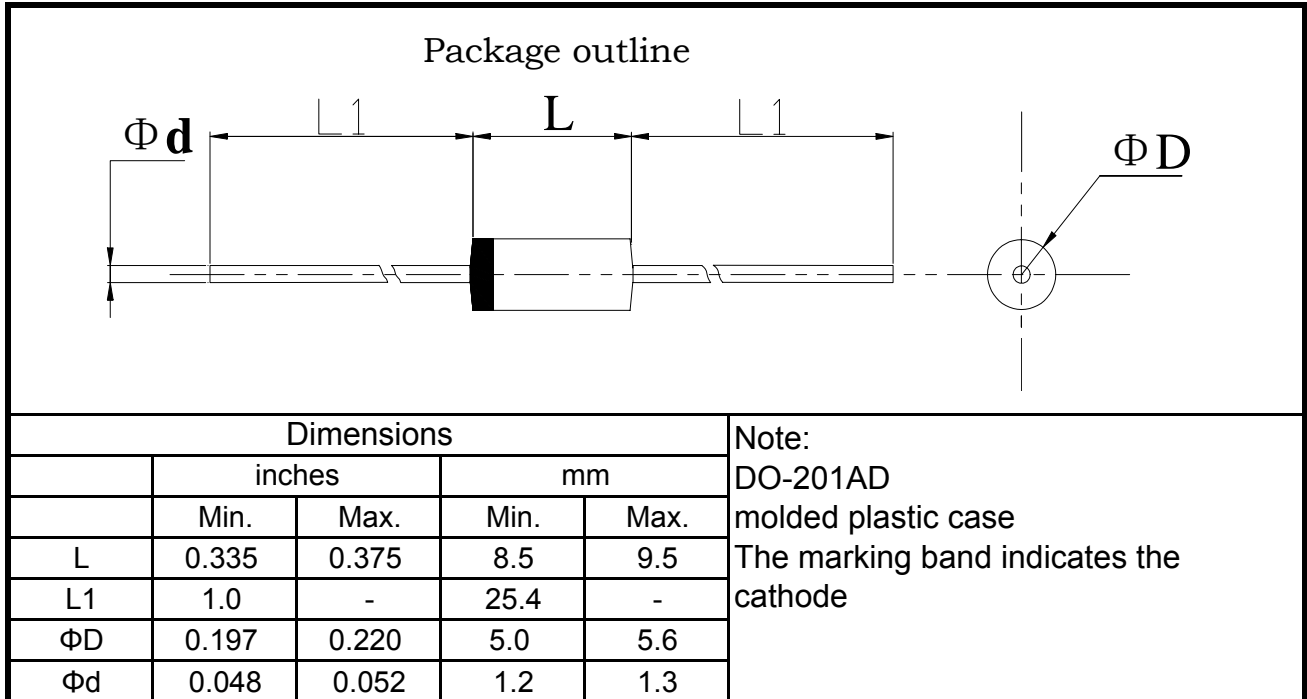

FIG.5 - TYPICAL JUNCTION CAPACITANCE



**5.Package Dimensions in inches and (millimeters)**

## Packing Of Plastic-Sealed Axial Lead Diodes

### 1. 卷盘/Reel Packing (52mm)

A: 卷盘规格/Reel spec.

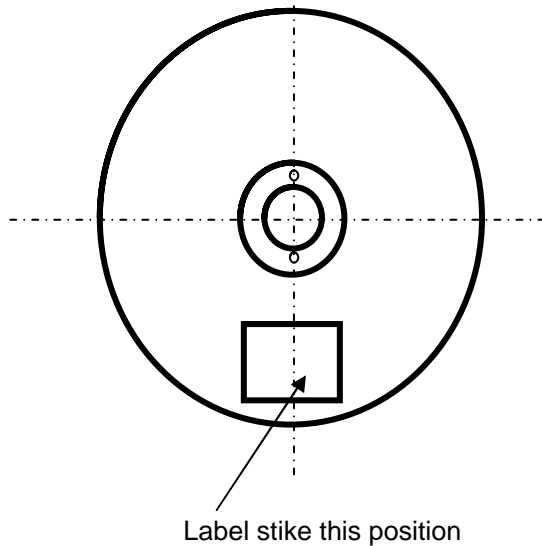

Unit:mm

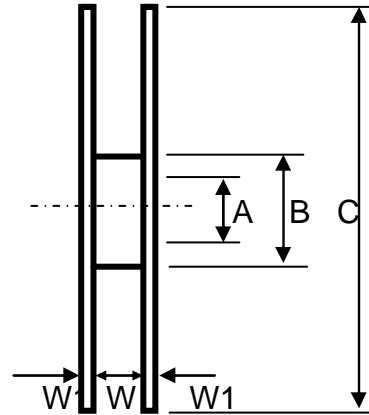

Item	Symbol	Dimension
Dimeter	A	76.4±0.1
	B	82.5±0.2
	C	330±0.5
Width	W	72±0.2
Thickness	W1	3±0.2

B: 外箱规格/Outer Box Specification

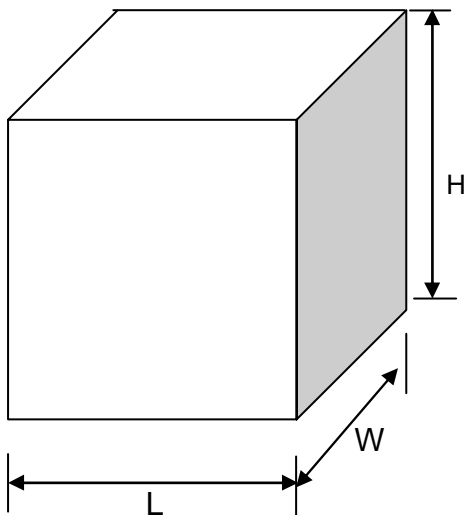

Item	Symbol	Dimension
Size	L	350±2
	W	350±2
	H	340±4

按以上包装方式: (As per the above spec)

	外型/Outside		
	DO-41 & A-405	DO-15	DO-201AD
Q'ty/Taping	5K	4K	1.4K
Q'ty/Packing Case	20K	16K	5.6K

**2. 弹带盒装/Ammo Packing**

Unit:mm

**A: 弹带盒规格/Ammo Box Spec.**



Item	Symbol	Dimension	Notes
Box's Size	L	260±2	52mm TYPE
	W	76±2	
	H	100±4	
	L	250±3	26mm TYPE
	W	45±3	
	H	95±5	

**B: 外箱规格/Outer Box Specification**

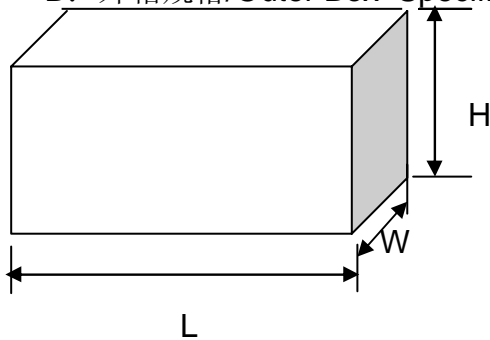

Item	Symbol	Dimension	Notes
Case's Size	L	430±2	52mm TYPE
	W	280±2	
	H	225±4	
	L	435±3	26mm TYPE
	W	280±3	
	H	295±5	

按以上包装方式: (As per the above spec)

	外型/Outside		
	A-405 & DO-41 & R-1	DO-15	DO-201AD
Q'ty/Taping	3K	2K	0.8K
Q'ty/Packing Case 26mm/TYPE	30K	20K	7.2K
Q'ty/Packing Case 52mm/TYPE	60K	40K	14.4K

**3. 散装/Bulk Packing**

**A. 包装盒尺寸/Box Dimension**

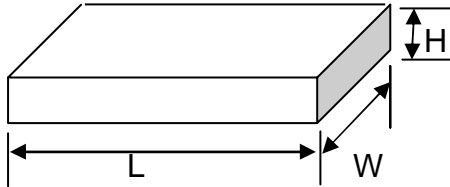

( DO-41&DO-15 )

Item	Symbol	Dimension
Box's Size	L	200±2
	W	84±2
	H	21±2

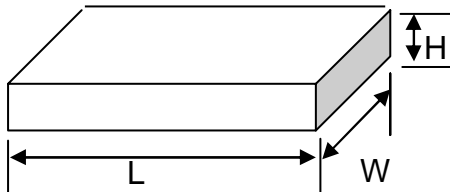

( DO-201AD )

Item	Symbol	Dimension
Box's Size	L	200±2
	W	84±2
	H	29±2

**B: 外箱规格/Outer Box Specification**

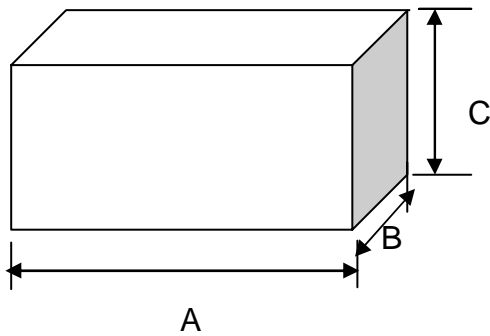

Item	Symbol	Dimension
Case's Size	L	465±2
	W	225±2
	H	260±4

按以上包装方式: (As per the above spec)

	外型/Outside		
	DO-41&A-405&R-1	DO-15	DO-201AD
Q'ty/Taping	1K	0.5K	0.3K
Q'ty/Packing Case	50K	25K	12K

4. 编带图形及规格/Taping Specification

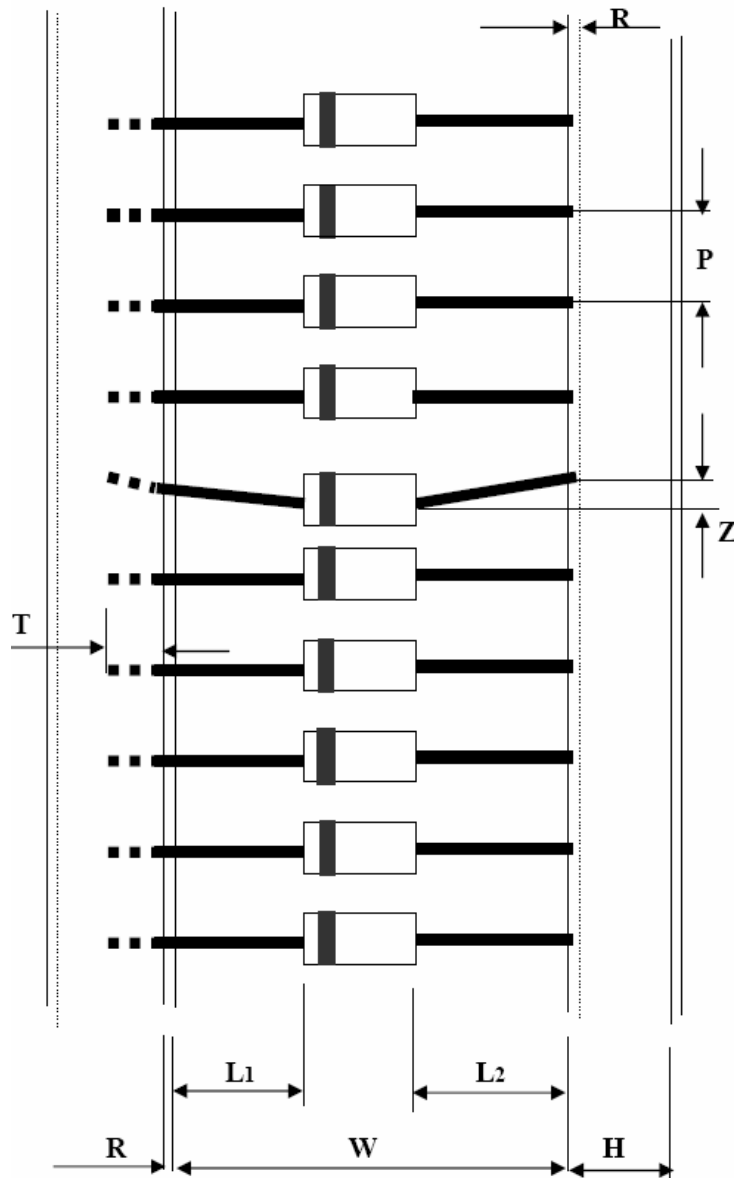

Unit:mm

尺寸代号	编带尺寸/Tape Dimension		
Dimension Code	26/tape	52/tape	52/tape#
W	26 0.0/+1.6	52 -1.0/+2.0	52 -1.0/+2.0
P	5±0.5	5±0.5	10±0.5
L1-L2	<1.0	<1.2	<1.2
H	6±1.0	6±1.0	6±1.0
Z	<1.2	<1.2	<1.2
R	<1.0	<1.0	<1.0
T	>3.2	>3.2	>3.2

注: 52编带# 为DO-201AD编带规格

Remark: 52 tape# is DO-201AD taping spec.