

DUAL JFET INPUT OPERATIONAL AMPLIFIERS

The KF442 is a dual low power operational amplifier. The key features of this op amp are low power, low input offset voltage, high slew rate, high gain bandwidth.

FEATURES

- Low supply current : 400pA MAX
- Low input bias Current : 50pA MAX
- Low input offset voltage : 1mV MAX
- High slew rate : 1V/ μ s
- High gain bandwidth : 1MHz

BLOCK DIAGRAM

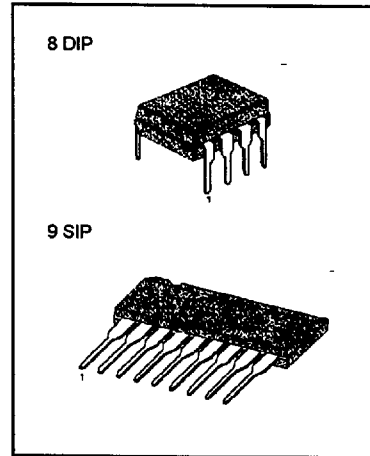
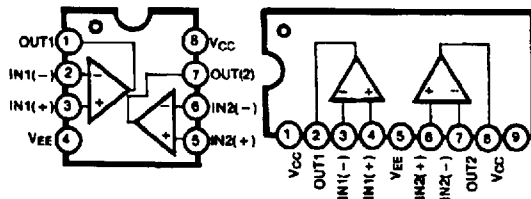

ORDERING INFORMATION

Device	Package	Operating Temperature
KF442	8 DIP	0 ~ +70°C
KF442A	8 DIP	
KF442S	9 SIP	
KF442AS	9 SIP	

SCHEMATIC DIAGRAM (One Section Only)

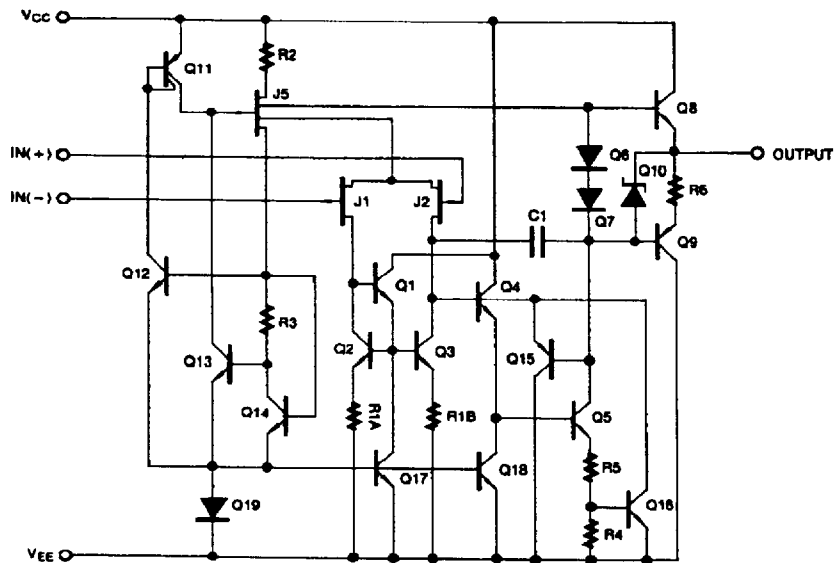

ABSOLUTE MAXIMUM RATINGS

Characteristics	Symbol	Value	Unit
Power Supply Voltage KF442 KF442A	V_{CC}	± 18 ± 20	V
Differential Input Voltage	$V_{I(DIFF)}$	± 30	V
Input Voltage range	V_I	± 15	V
Output Short Circuit Duration		Continuous	
Power Dissipation	P_D		mW
Operating Temperature Range KF442/A	T_{OPR}	0 ~ + 70	$^{\circ}C$
Storage Temperature Range	T_{STG}	-65 ~ + 150	$^{\circ}C$

ELECTRICAL CHARACTERISTICS

($T_A=25^{\circ}C$, unless otherwise specified)

Characteristic	Symbol	Test Conditions	KF442A			KF442			Unit
			Min	Typ	Max	Min	Typ	Max	
Input Offset Voltage	V_{IO}	$R_S = 10K\Omega$ Note 1		0.5	1.0		1.0	5.0	mV
Input Offset Voltage Drift	$\Delta V_{IO}/\Delta T$	$R_S = 10K\Omega$		7	10		7	7.5	$\mu V/^{\circ}C$
Input Offset Current	I_{IO}	Note 1		5	25		5	50	pA
Large Signal Voltage Gain	I_{BIAS}	Note 1		10	50		10	100	pA
Large Signal Voltage Gain	G_V	$R_L = 10K\Omega$ $V_{O(P,P)} = \pm 10V$ Note 1	50	200		25	200		V/mV
Output Voltage Swing	$V_{O(P,P)}$	$R_S = 10K\Omega$	± 17	± 18		± 12	± 13		V
Input Voltage Range	$V_{I(R)}$			+18 -17		± 11	+15 -12		V
Common-Mode Rejection Ratio	CMRR	$R_S \leq 10K\Omega$	80	100		70	95		dB
Power Supply Rejection Ratio	PSRR	$R_S \leq 10K\Omega$	80	100		70	90		dB
Input Resistance	R_I			10^{12}		10^{12}			Ω
Supply Current	I_{CC}			300	400		400	500	μA
Slew Rate	SR		0.8	1		0.6	1		V/ μS
Gain Bandwidth Product			0.8	1		0.6	1		MHz
Channel Separation	CS	f = 1Hz-20KHz (input referenced)		120			120		dB
Equivalent Input Noise Voltage	V_{NI}	$R_S = 100\Omega$ f = 1KHz		35			35		nV/ \sqrt{Hz}
Equivalent Input Noise Current	I_{NI}	f = 1KHz		0.01			0.01		pA/ \sqrt{Hz}

NOTE 1. KF442/A : $0 \leq T_A \leq +70^{\circ}C$

Dimensions in Millimeters

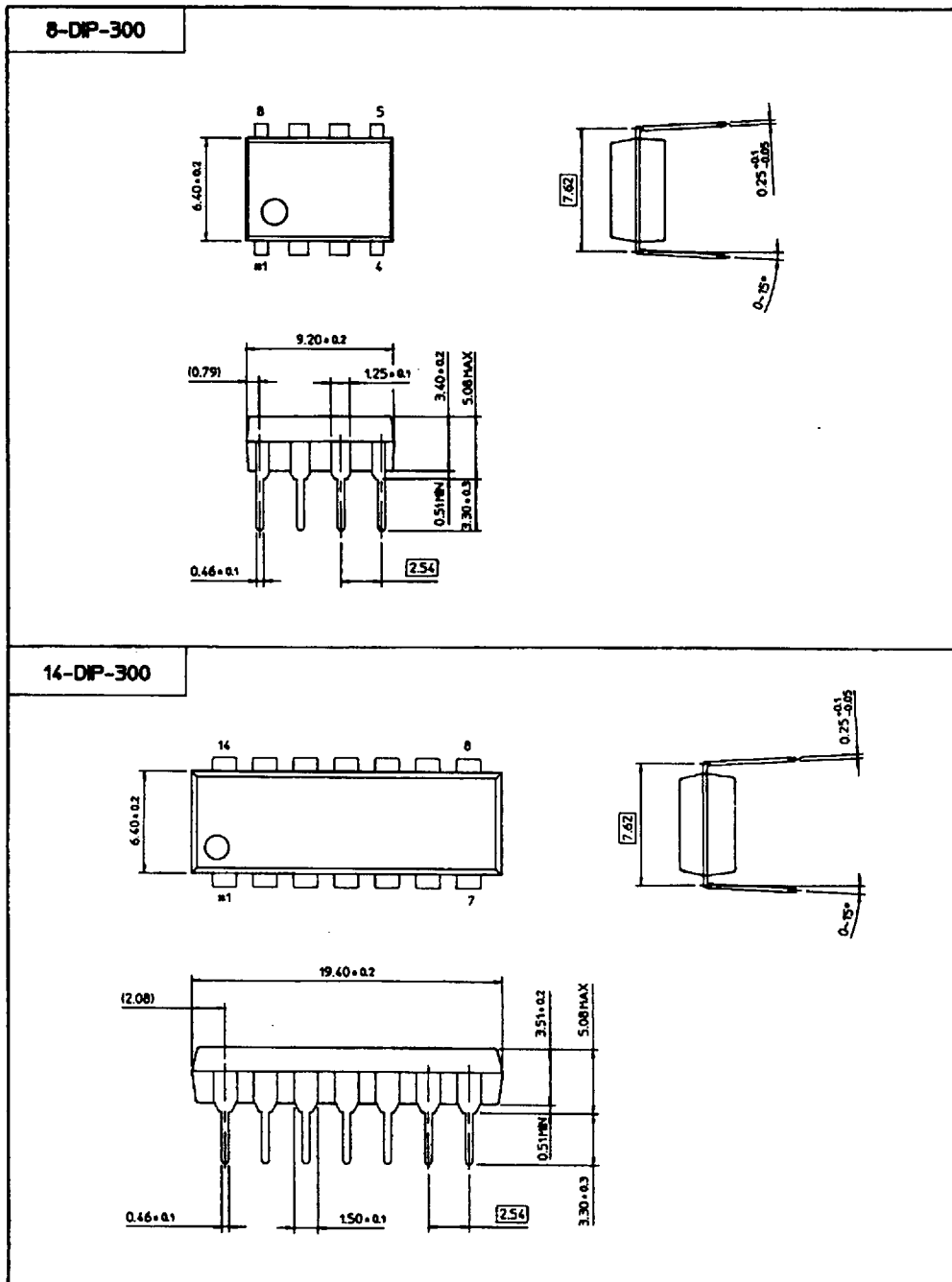

9(7)-SIP

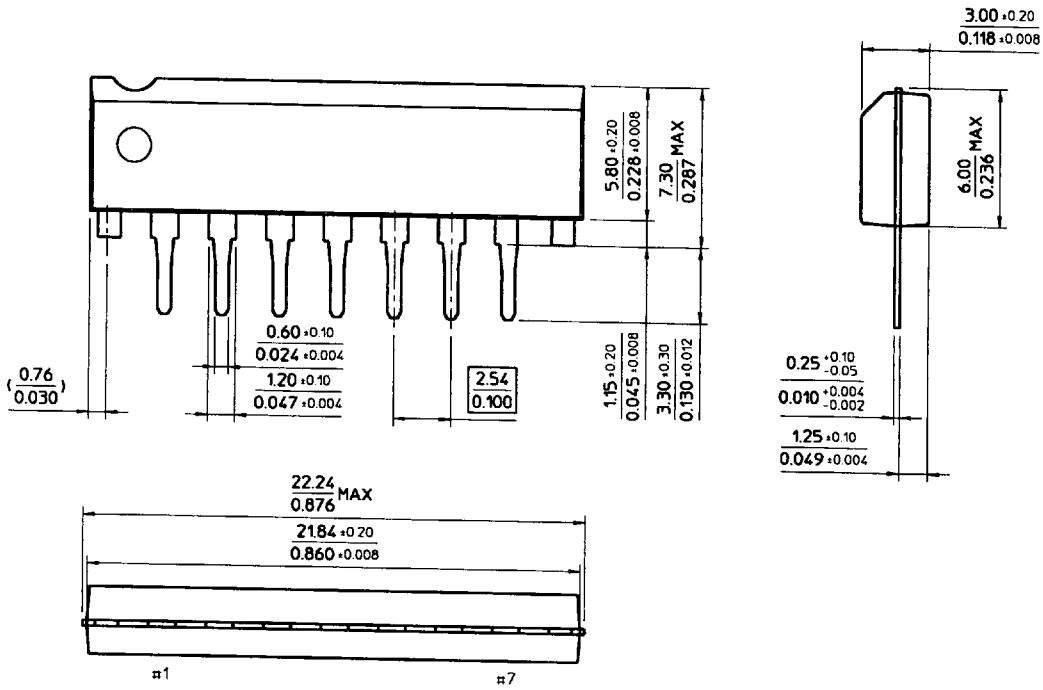

9(8)-SIP-A

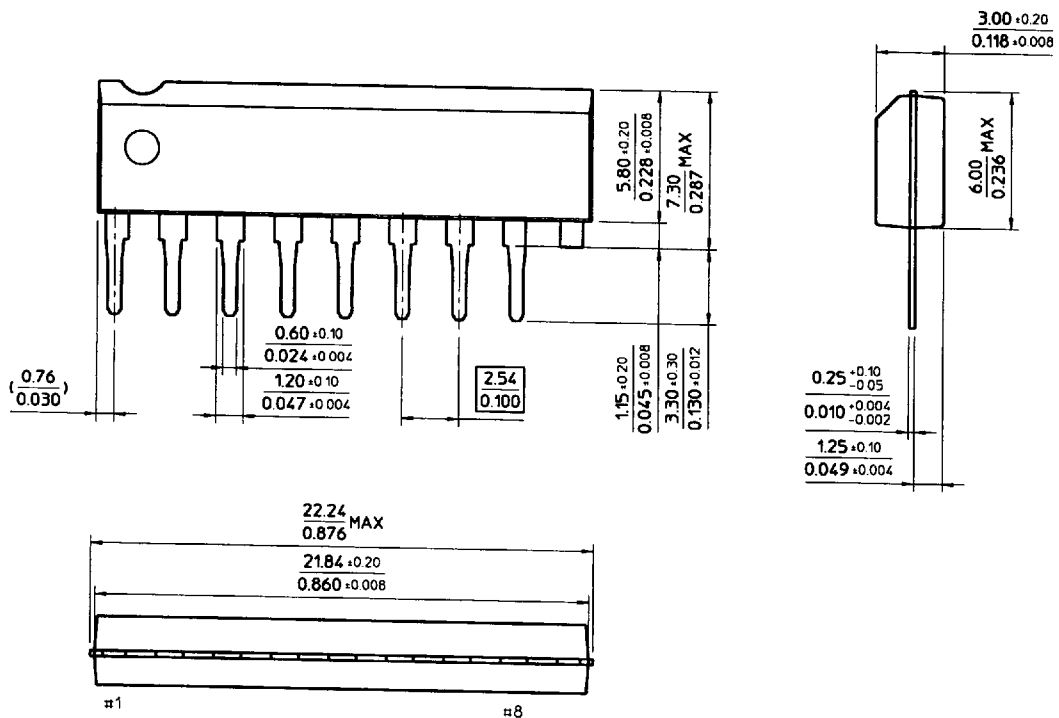

9(8)-SIP-B

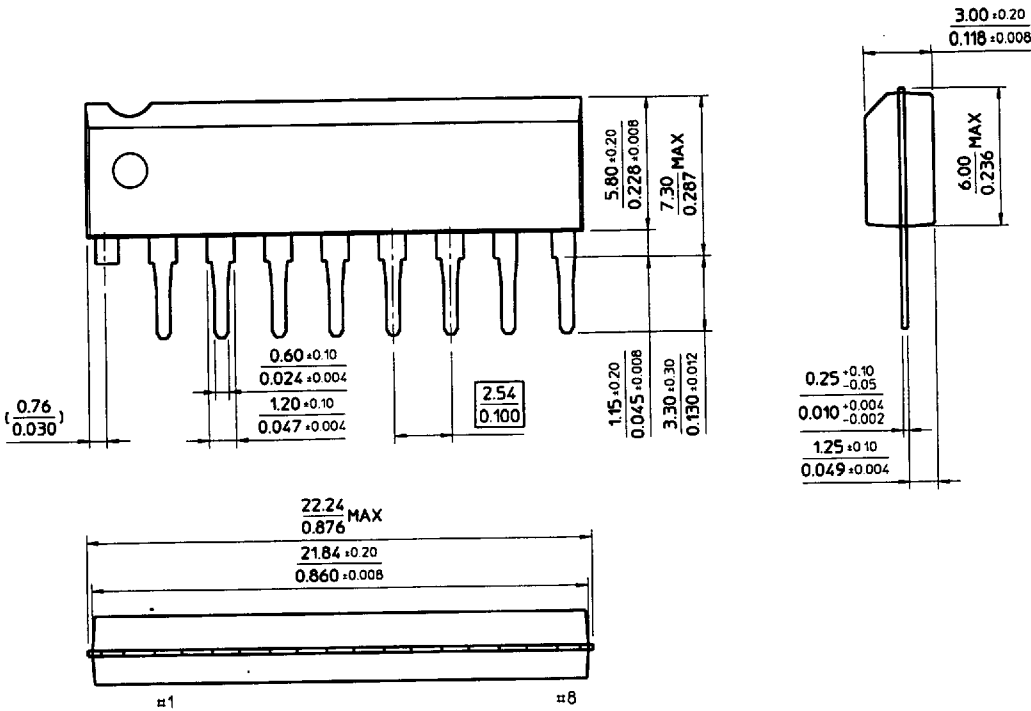

9-SIP

