

4-1123722-4 ✓ ACTIVE

Economy Power

TE Internal #: 4-1123722-4

Housing, Plug, Wire-to-Board, 4 Position, .156 in [3.96 mm]
Centerline, Crimp, 1 Row, Red, Mating Retention, Wire & Cable,
Economy Power

[View on TE.com >](#)



Connectors > PCB Connectors > Wire-to-Board Connectors > Wire-to-Board Connector Assemblies & Housings

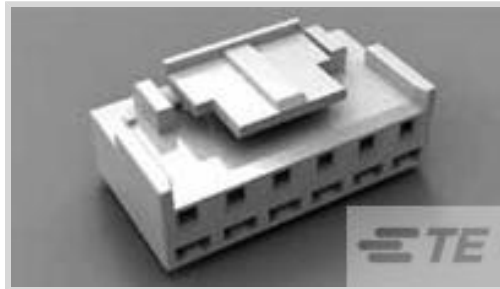

Connector Product Type: **Housing**

Connector & Housing Type: **Plug**

Connector System: **Wire-to-Board**

Number of Positions: **4**

Centerline (Pitch): **3.96 mm [.156 in]**

Features

Product Type Features

Connector Product Type	Housing
Connector & Housing Type	Plug
Connector System	Wire-to-Board
Sealable	No
Connector & Contact Terminates To	Wire & Cable

Configuration Features

Number of Positions	4
Number of Rows	1

Electrical Characteristics

Dielectric Withstanding Voltage (Max)	1500 VAC
Insulation Resistance	1000 MΩ
Operating Voltage	250 VAC

Body Features

Primary Product Color	Red
-----------------------	-----

Contact Features

Contact Layout	Inline
Contact Type	Socket
Contact Current Rating (Max)	8 A



Termination Features

Termination Method to Wire & Cable	Crimp
------------------------------------	-------

Mechanical Attachment

Strain Relief	Without
Mating Retention Type	Latch
Mating Retention	With
Connector Mounting Type	Cable Mount (Free-Hanging)

Housing Features

Housing Entry Configuration	Both Ends Closed
Housing Material	Nylon - GF
Centerline (Pitch)	3.96 mm [.156 in]

Dimensions

Connector Length	15.78 mm [.621 in]
Connector Height	10.5 mm [.413 in]
Connector Width	13.3 mm [.524 in]
Compatible Insulation Diameter Range	1.7 – 3 mm [.067 – .118 in]
Wire Size	.34 – .75 mm ²

Usage Conditions

Operating Temperature Range	-25 – 105 °C [-13 – 221 °F]
-----------------------------	-----------------------------

Operation/Application

Circuit Application	Power & Signal
---------------------	----------------

Industry Standards

Glow Wire Rating	Standard Part - Not Glow Wire
UL Flammability Rating	UL 94V-0

Packaging Features

Packaging Quantity	2000
Packaging Method	Bag

Product Compliance

For compliance documentation, visit the product page on TE.com>

EU RoHS Directive 2011/65/EU	Compliant
------------------------------	-----------



EU ELV Directive 2000/53/EC

Compliant

China RoHS 2 Directive MIIT Order No 32, 2016

No Restricted Materials Above Threshold

EU REACH Regulation (EC) No. 1907/2006

Current ECHA Candidate List: JUNE 2023 (235)

Candidate List Declared Against: JUNE 2023 (235)

Does not contain REACH SVHC

Halogen Content

Low Halogen - Br, Cl, F, I < 900 ppm per homogenous material. Also BFR/CFR/PVC Free

Solder Process Capability

Not applicable for solder process capability

Product Compliance Disclaimer

This information is provided based on reasonable inquiry of our suppliers and represents our current actual knowledge based on the information they provided. This information is subject to change. The part numbers that TE has identified as EU RoHS compliant have a maximum concentration of 0.1% by weight in homogenous materials for lead, hexavalent chromium, mercury, PBB, PBDE, DBP, BBP, DEHP, DIBP, and 0.01% for cadmium, or qualify for an exemption to these limits as defined in the Annexes of Directive 2011/65/EU (RoHS2). Finished electrical and electronic equipment products will be CE marked as required by Directive 2011/65/EU. Components may not be CE marked. Additionally, the part numbers that TE has identified as EU ELV compliant have a maximum concentration of 0.1% by weight in homogenous materials for lead, hexavalent chromium, and mercury, and 0.01% for cadmium, or qualify for an exemption to these limits as defined in the Annexes of Directive 2000/53/EC (ELV). Regarding the REACH Regulation, the information TE provides on SVHC in articles for this part number is based on the latest European Chemicals Agency (ECHA) 'Guidance on requirements for substances in articles' posted at this URL: <https://echa.europa.eu/guidance-documents/guidance-on-reach>

Compatible Parts



TE Part # 1318912-1
EP CONN LP REC



TE Part # 1-1318301-4
3.96EP HDR ASSY 4(7)P NAT/TUBE



TE Part # 1123721-2
ECONOMY POWER CONN REC CONT



TE Part # 1-1123724-4
3.96EP HDR ASSY 4(7)P NATURAL



TE Part # 1744494-4
04P EP-II HOUSING, YELLOW



TE Part # 1744416-4
4 POS EP II HSG, GLOW WIRE



TE Part # 1123721-1
EP CONN. REC CONTACT



TE Part # 1-1565035-4
EP CONN HDR ASSY 4/6P SPECIAL



Also in the Series | Economy Power

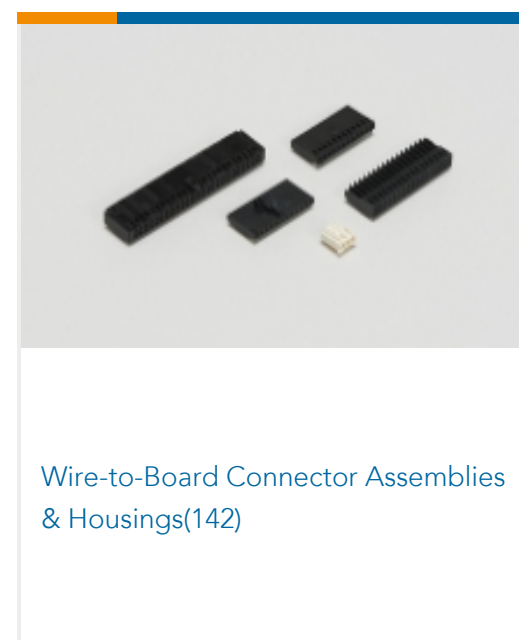
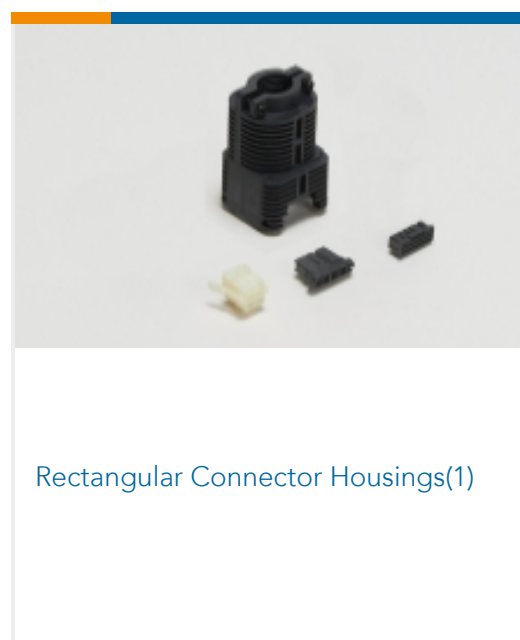
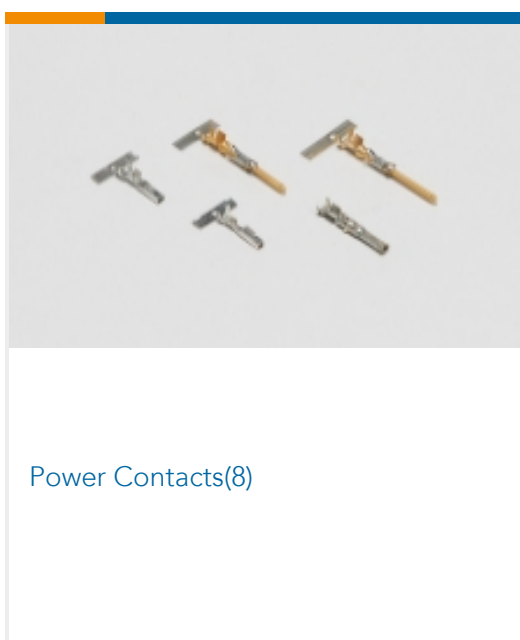
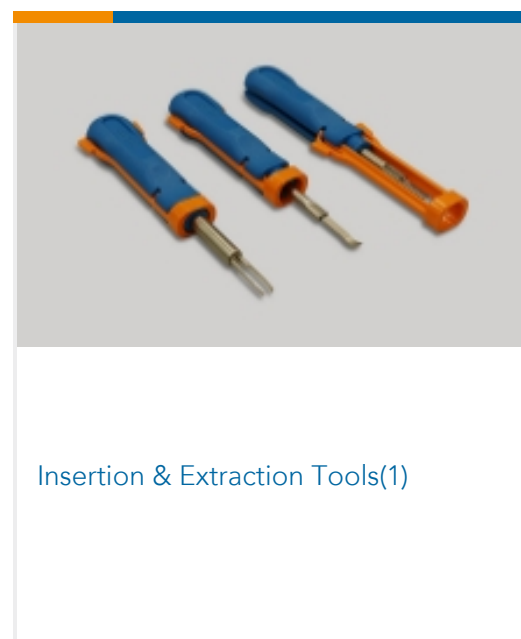
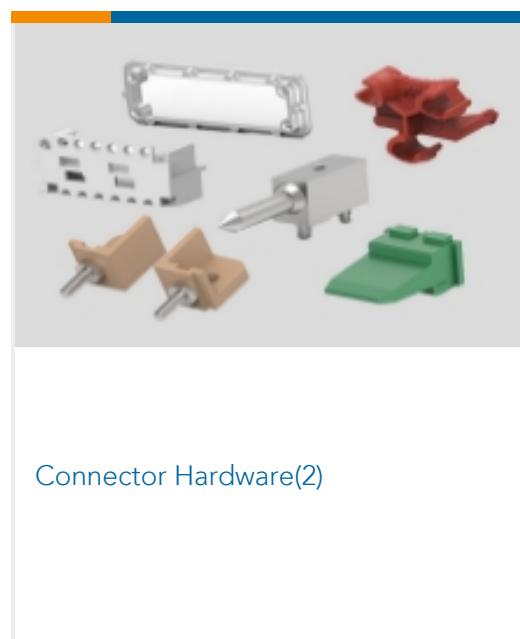
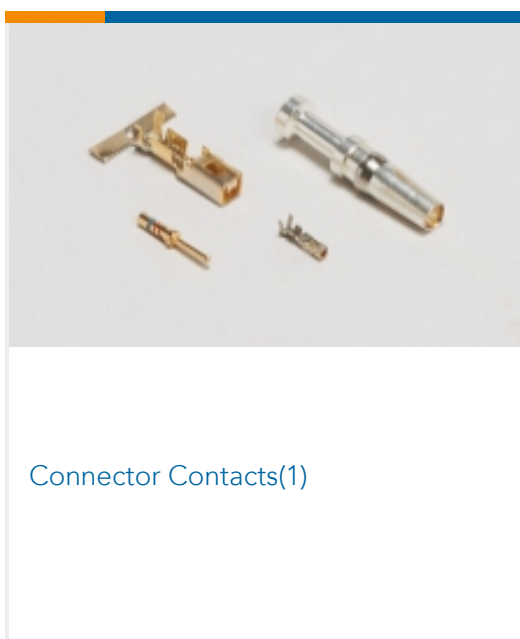

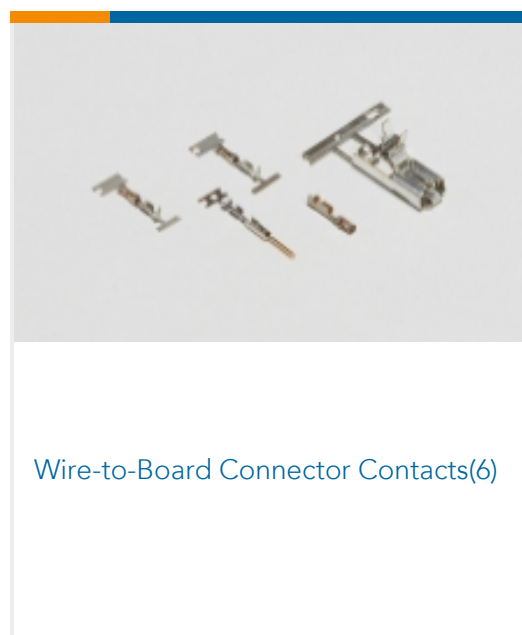

Customers Also Bought

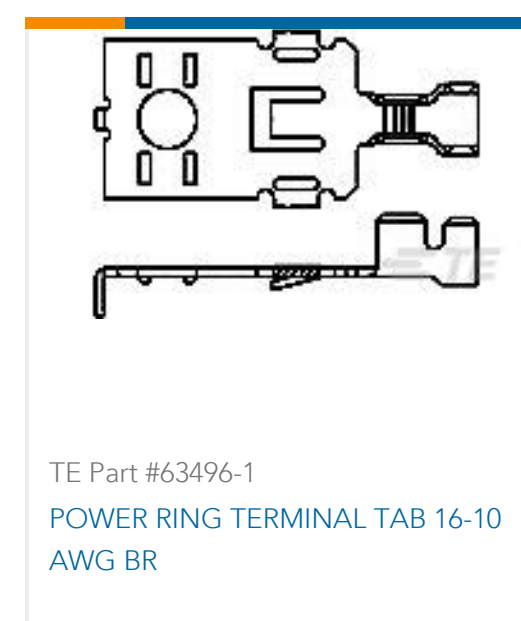
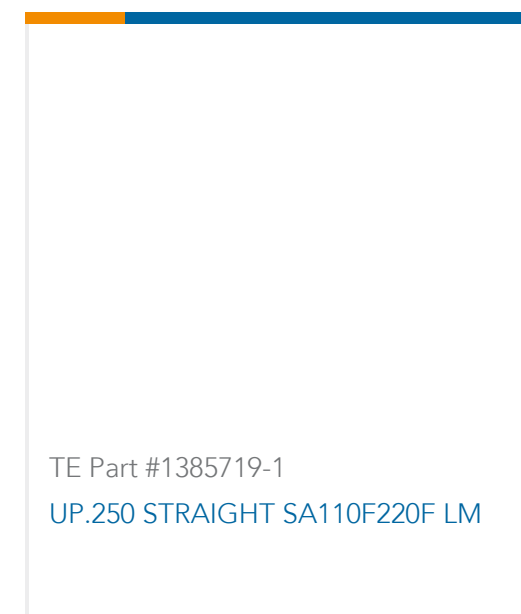

Documents

Product Drawings

[3.96 EP PLUG HSG 4P\(RED\)](#)

English

CAD Files

[3D PDF](#)

3D

Customer View Model

[ENG_CVM_CVM_4-1123722-4_P.2d_dxf.zip](#)

English

Customer View Model

[ENG_CVM_CVM_4-1123722-4_P.3d_igs.zip](#)

English

Customer View Model

[ENG_CVM_CVM_4-1123722-4_P.3d_stp.zip](#)

English

By downloading the CAD file I accept and agree to the [Terms and Conditions](#) of use.



Datasheets & Catalog Pages

[1-1773885-9 Economy Power Connectors](#)

English

Product Specifications

[Application Specification](#)

English

Instruction Sheets

[Instruction Sheet \(non U.S.\)](#)

Japanese

[Economy Power \(EP\) Connector](#)

Japanese

Agency Approvals

[UL Report](#)

English