

3A LOW DROP POSITIVE VOLTAGE REGULATOR ADJUSTABLE AND FIXED

- TYPICAL DROPOUT 1.3V (AT 3A)
- THREE TERMINAL ADJUSTABLE OR FIXED OUTPUT VOLTAGE 1.5V, 1.8V, 2.5V, 2.85V, 3.3V, 3.6V, 5V, 8V, 9V, 12V.
- GUARANTEED OUTPUT CURRENT UP TO 3A
- OUTPUT TOLERANCE $\pm 2\%$ AT 25°C AND $\pm 3\%$ IN FULL TEMPERATURE RANGE
- INTERNAL POWER AND THERMAL LIMIT
- WIDE OPERATING TEMPERATURE RANGE -40°C TO 125°C
- PACKAGE AVAILABLE: DPAK
- PINOUT COMPATIBILITY WITH STANDARD ADJUSTABLE VREG

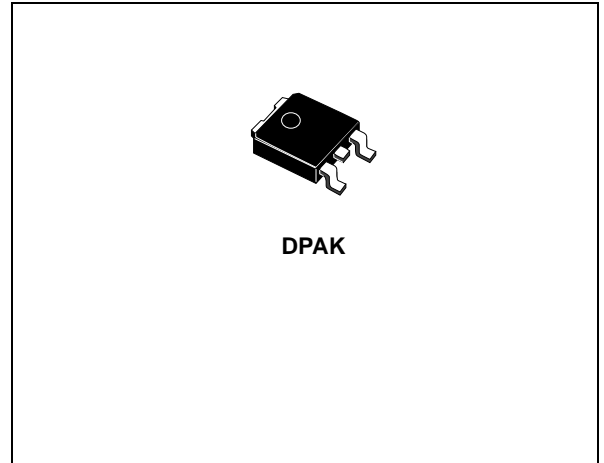

DESCRIPTION

The LD1085 is a LOW DROP Voltage Regulator able to provide up to 3A of Output Current. Dropout is guaranteed at a maximum of 1.5V at the maximum output current, decreasing at lower loads. The LD1085 is pin to pin compatible with the older 3-terminal adjustable regulators, but has better performances in term of drop and output tolerance.

A 2.85V output version is suitable for SCSI-2 active termination. Unlike PNP regulators, where a part of the output current is wasted as quiescent current, the LD1085 quiescent current flows into the load, so increase efficiency. Only a 10 μ F minimum capacitor is need for stability. The device is supplied in DPAK. On chip trimming allows the regulator to reach a very tight output voltage tolerance, within $\pm 2\%$ at 25°C.

Figure 1: Schematic Diagram

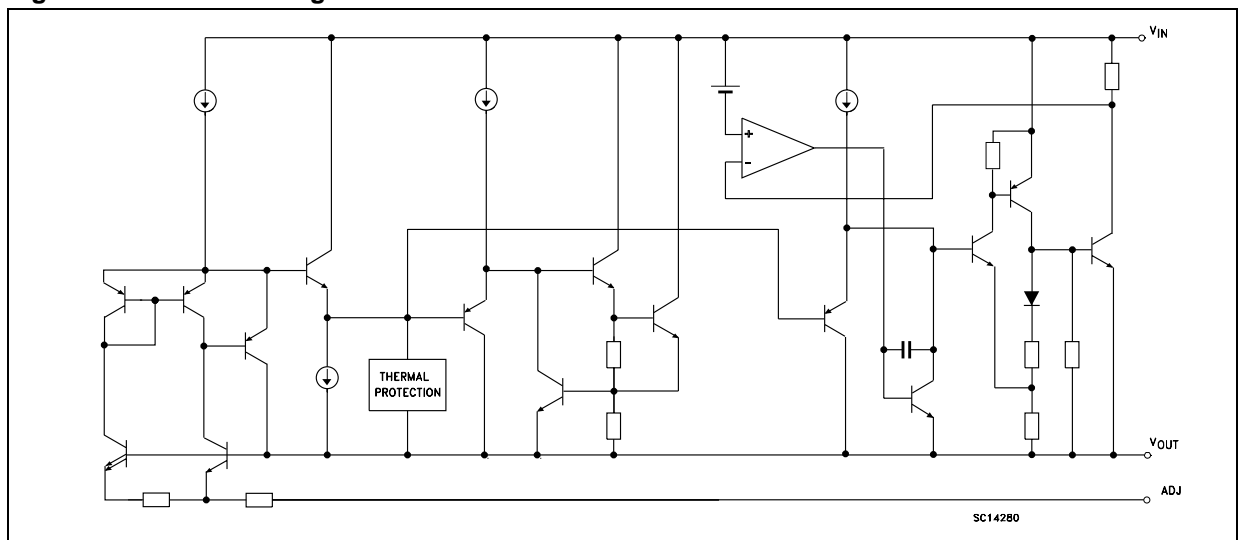

Figure 2: Pin Connection (top view)

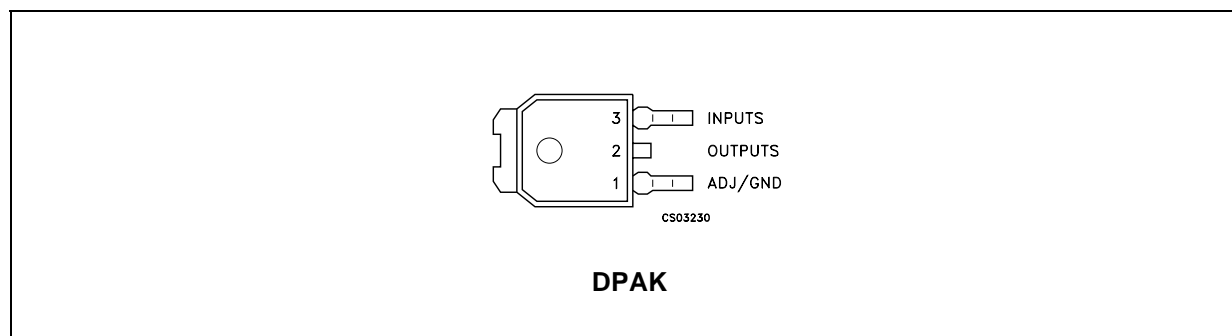

Table 1: Order Codes

DPAK (*)	OUTPUT VOLTAGE
LD1085CDT15	1.5 V
LD1085CDT18	1.8 V
LD1085CDT25	2.5 V
LD1085CDT28	2.85 V
LD1085CDT33	3.3 V
LD1085CDT36	3.6 V
LD1085CDT50	5.0 V
LD1085CDT80	8.0 V
LD1085CDT90	9.0 V
LD1085CDT12	12.0 V
LD1085CDT	ADJ

(*) Available in Tape & Reel with the suffix "R" for fixed version and "-R" for adjustable version.

Table 2: Absolute Maximum Ratings

Symbol	Parameter	Value	Unit
V_I	DC Input Voltage	30	V
I_O	Output Current	Internally Limited	mA
P_D	Power Dissipation	Internally Limited	mW
T_{stg}	Storage Temperature Range	-55 to +150	°C
T_{op}	Operating Junction Temperature Range	-40 to +125	°C

Absolute Maximum Ratings are those values beyond which damage to the device may occur. Functional operation under these condition is not implied.

Table 3: Thermal Data

Symbol	Parameter	DPAK	Unit
$R_{thj-case}$	Thermal Resistance Junction-case	3	°C/W
$R_{thj-amb}$	Thermal Resistance Junction-ambient	62.5	°C/W

Figure 3: Application Circuits

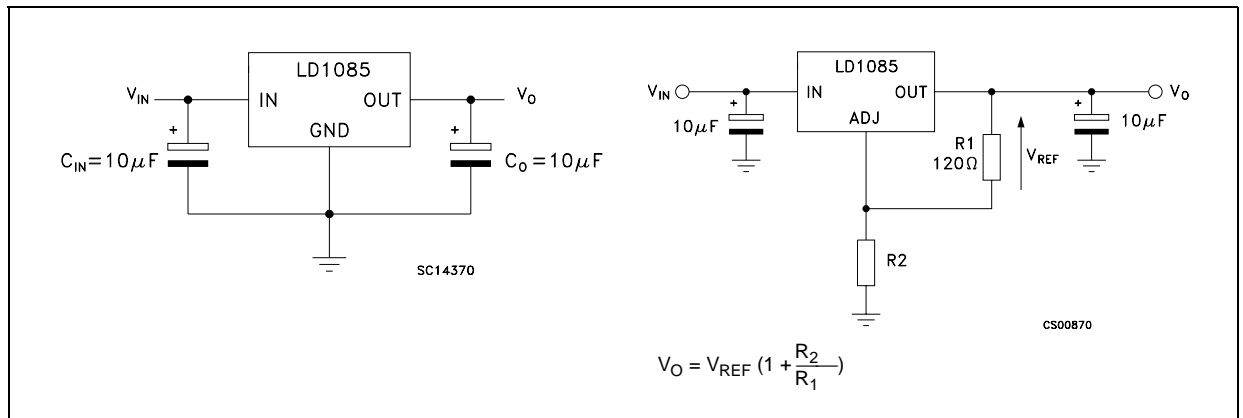

Table 4: Electrical Characteristics Of LD1085CDT15 ($V_I=4.5V$, $C_I = C_O = 10\mu F$, $T_A = -40$ to $125^\circ C$, unless otherwise specified.)

Symbol	Parameter	Test Conditions	Min.	Typ.	Max.	Unit
V_O	Output Voltage	$I_O = 0 \text{ mA}$ $T_J = 25^\circ C$	1.47	1.5	1.53	V
		$I_O = 0$ to $3A$ $V_I = 3.1$ to $30V$ (note 1)	1.455	1.5	1.545	V
ΔV_O	Line Regulation	$I_O = 0 \text{ mA}$ $V_I = 3.1$ to $18V$ $T_J = 25^\circ C$		0.2	4	mV
		$I_O = 0 \text{ mA}$ $V_I = 3.1$ to $15V$		0.4	4	mV
ΔV_O	Load Regulation	$I_O = 0$ to $3A$ $T_J = 25^\circ C$		2	10	mV
		$I_O = 0$ to $3A$		4	20	V
V_d	Dropout Voltage	$I_O = 3 \text{ A}$		1.3	1.5	V
I_q	Quiescent Current	$V_I \leq 30V$		5	10	mA
I_{sc}	Short Circuit Current	$V_I - V_O = 5V$	3.2	4.5		A
		$V_I - V_O = 25V$	0.2	0.5		A
	Thermal Regulation	$T_A = 25^\circ C$, 30ms pulse		0.003	0.015	%/W
SVR	Supply Voltage Rejection	$f = 120 \text{ Hz}$, $C_O = 25 \mu F$, $I_O = 3A$ $V_I = 7.5 \pm 3V$	60	75		dB
eN	RMS Output Noise Voltage (% of V_O)	$T_A = 25^\circ C$ $f = 10\text{Hz}$ to 10KHz		0.003		%
S	Temperature Stability			0.5		%
S	Long Term Stability	$T_A = 125^\circ C$ 1000Hrs		0.5		%

NOTE 1: See short-circuit current curve for available output current at fixed dropout.

Table 5: Electrical Characteristics Of LD1085CDT18 ($V_I=4.8V$, $C_I = C_O = 10\mu F$, $T_A = -40$ to $125^\circ C$, unless otherwise specified.)

Symbol	Parameter	Test Conditions	Min.	Typ.	Max.	Unit
V_O	Output Voltage	$I_O = 0 \text{ mA}$ $T_J = 25^\circ C$	1.764	1.8	1.836	V
		$I_O = 0$ to $3A$ $V_I = 3.4$ to $30V$ (note 1)	1.746	1.8	1.854	V
ΔV_O	Line Regulation	$I_O = 0 \text{ mA}$ $V_I = 3.4$ to $18V$ $T_J = 25^\circ C$		0.2	4	mV
		$I_O = 0 \text{ mA}$ $V_I = 3.4$ to $15V$		0.4	4	mV
ΔV_O	Load Regulation	$I_O = 0$ to $3A$ $T_J = 25^\circ C$		2	10	mV
		$I_O = 0$ to $3A$		4	20	V
V_d	Dropout Voltage	$I_O = 3 \text{ A}$		1.3	1.5	V
I_q	Quiescent Current	$V_I \leq 30V$		5	10	mA
I_{sc}	Short Circuit Current	$V_I - V_O = 5V$	3.2	4.5		A
		$V_I - V_O = 25V$	0.2	0.5		A
	Thermal Regulation	$T_A = 25^\circ C$, 30ms pulse		0.003	0.015	%/W
SVR	Supply Voltage Rejection	$f = 120 \text{ Hz}$, $C_O = 25 \mu F$, $I_O = 3A$ $V_I = 7.5 \pm 3V$	60	75		dB
eN	RMS Output Noise Voltage (% of V_O)	$T_A = 25^\circ C$ $f = 10\text{Hz}$ to 10KHz		0.003		%
S	Temperature Stability			0.5		%
S	Long Term Stability	$T_A = 125^\circ C$ 1000Hrs		0.5		%

NOTE 1: See short-circuit current curve for available output current at fixed dropout.

Table 6: Electrical Characteristics Of LD1085CDT25 ($V_I=5.5V$, $C_I = C_O = 10\mu F$, $T_A = -40$ to $125^\circ C$, unless otherwise specified.)

Symbol	Parameter	Test Conditions	Min.	Typ.	Max.	Unit
V_O	Output Voltage	$I_O = 0 \text{ mA}$ $T_J = 25^\circ C$	2.45	2.5	2.55	V
		$I_O = 0$ to $3A$ $V_I = 4.1$ to $30V$ (note 1)	2.425	2.5	2.575	V
ΔV_O	Line Regulation	$I_O = 0 \text{ mA}$ $V_I = 4.1$ to $18V$ $T_J = 25^\circ C$		0.2	5	mV
		$I_O = 0 \text{ mA}$ $V_I = 4.1$ to $18V$		0.4	5	mV
ΔV_O	Load Regulation	$I_O = 0$ to $3A$ $T_J = 25^\circ C$		2	10	mV
		$I_O = 0$ to $3A$		4	20	V
V_d	Dropout Voltage	$I_O = 3 \text{ A}$		1.3	1.5	V
I_q	Quiescent Current	$V_I \leq 30V$		5	10	mA
I_{sc}	Short Circuit Current	$V_I - V_O = 5V$	3.2	4.5		A
		$V_I - V_O = 25V$	0.2	0.5		A
	Thermal Regulation	$T_A = 25^\circ C$, 30ms pulse		0.008	0.04	%/W
SVR	Supply Voltage Rejection	$f = 120 \text{ Hz}$, $C_O = 25 \mu F$, $I_O = 3A$ $V_I = 7.5 \pm 3V$	60	72		dB
eN	RMS Output Noise Voltage (% of V_O)	$T_A = 25^\circ C$ $f = 10\text{Hz}$ to 10KHz		0.003		%
S	Temperature Stability			0.5		%
S	Long Term Stability	$T_A = 125^\circ C$ 1000Hrs		0.5		%

NOTE 1: See short-circuit current curve for available output current at fixed dropout.

Table 7: Electrical Characteristics Of LD1085CDT285 ($V_I=5.85V$, $C_I = C_O=10\mu F$, $T_A = -40$ to $125^\circ C$, unless otherwise specified.)

Symbol	Parameter	Test Conditions	Min.	Typ.	Max.	Unit
V_O	Output Voltage	$I_O = 0$ mA $T_J = 25^\circ C$	2.793	2.85	2.907	V
		$I_O = 0$ to 3A $V_I = 4.5$ to 30V (note 1)	2.765	2.85	2.935	V
ΔV_O	Line Regulation	$I_O = 0$ mA $V_I = 4.5$ to 18V $T_J = 25^\circ C$		0.2	6	mV
		$I_O = 0$ mA $V_I = 4.5$ to 18V		0.5	6	mV
ΔV_O	Load Regulation	$I_O = 0$ to 3A $T_J = 25^\circ C$		3	15	mV
		$I_O = 0$ to 3A		7	20	V
V_d	Dropout Voltage	$I_O = 3$ A		1.3	1.5	V
I_q	Quiescent Current	$V_I \leq 30V$		5	10	mA
I_{sc}	Short Circuit Current	$V_I - V_O = 5V$	3.2	4.5		A
		$V_I - V_O = 25V$	0.2	0.5		A
	Thermal Regulation	$T_A = 25^\circ C$, 30ms pulse		0.008	0.04	%/W
SVR	Supply Voltage Rejection	$f = 120$ Hz, $C_O = 25 \mu F$, $I_O = 3A$ $V_I = 7.85 \pm 3V$	60	72		dB
eN	RMS Output Noise Voltage (% of V_O)	$T_A = 25^\circ C$ $f = 10$ Hz to 10KHz		0.003		%
S	Temperature Stability			0.5		%
S	Long Term Stability	$T_A = 125^\circ C$ 1000Hrs		0.5		%

NOTE 1: See short-circuit current curve for available output current at fixed dropout.

Table 8: Electrical Characteristics Of LD1085CDT33 ($V_I=6.3V$, $C_I = C_O=10\mu F$, $T_A = -40$ to $125^\circ C$, unless otherwise specified.)

Symbol	Parameter	Test Conditions	Min.	Typ.	Max.	Unit
V_O	Output Voltage	$I_O = 0$ mA $T_J = 25^\circ C$	3.234	3.35	3.366	V
		$I_O = 0$ to 3A $V_I = 4.9$ to 30V (note 1)	3.201	3.35	3.399	V
ΔV_O	Line Regulation	$I_O = 0$ mA $V_I = 4.9$ to 18V $T_J = 25^\circ C$		0.5	6	mV
		$I_O = 0$ mA $V_I = 4.9$ to 18V		1	6	mV
ΔV_O	Load Regulation	$I_O = 0$ to 3A $T_J = 25^\circ C$		3	15	mV
		$I_O = 0$ to 3A		7	20	V
V_d	Dropout Voltage	$I_O = 3$ A		1.3	1.5	V
I_q	Quiescent Current	$V_I \leq 30V$		5	10	mA
I_{sc}	Short Circuit Current	$V_I - V_O = 5V$	3.2	4.5		A
		$V_I - V_O = 25V$	0.2	0.5		A
	Thermal Regulation	$T_A = 25^\circ C$, 30ms pulse		0.008	0.04	%/W
SVR	Supply Voltage Rejection	$f = 120$ Hz, $C_O = 25 \mu F$, $I_O = 5A$ $V_I = 8.3 \pm 3V$	60	72		dB
eN	RMS Output Noise Voltage (% of V_O)	$T_A = 25^\circ C$ $f = 10$ Hz to 10KHz		0.003		%
S	Temperature Stability			0.5		%
S	Long Term Stability	$T_A = 125^\circ C$ 1000Hrs		0.5		%

NOTE 1: See short-circuit current curve for available output current at fixed dropout.

Table 9: Electrical Characteristics Of LD1085CDT36 ($V_I=6.6V$, $C_I = C_O = 10\mu F$, $T_A = -40$ to $125^\circ C$, unless otherwise specified.)

Symbol	Parameter	Test Conditions	Min.	Typ.	Max.	Unit
V_O	Output Voltage	$I_O = 0 \text{ mA}$ $T_J = 25^\circ C$	3.528	3.6	3.672	V
		$I_O = 0$ to $3A$ $V_I = 5.2$ to $30V$ (note 1)	3.492	3.6	3.708	V
ΔV_O	Line Regulation	$I_O = 0 \text{ mA}$ $V_I = 5.2$ to $18V$ $T_J = 25^\circ C$		0.5	10	mV
		$I_O = 0 \text{ mA}$ $V_I = 5.2$ to $18V$		1	10	mV
ΔV_O	Load Regulation	$I_O = 0$ to $3A$ $T_J = 25^\circ C$		3	15	mV
		$I_O = 0$ to $3A$		7	20	V
V_d	Dropout Voltage	$I_O = 3 \text{ A}$		1.3	1.5	V
I_q	Quiescent Current	$V_I \leq 30V$		5	10	mA
I_{sc}	Short Circuit Current	$V_I - V_O = 5V$	3.2	4.5		A
		$V_I - V_O = 25V$	0.2	0.5		A
	Thermal Regulation	$T_A = 25^\circ C$, 30ms pulse		0.008	0.04	%/W
SVR	Supply Voltage Rejection	$f = 120 \text{ Hz}$, $C_O = 25 \mu F$, $I_O = 3A$ $V_I = 8.6 \pm 3V$	60	72		dB
eN	RMS Output Noise Voltage (% of V_O)	$T_A = 25^\circ C$ $f = 10\text{Hz}$ to 10KHz		0.003		%
S	Temperature Stability			0.5		%
S	Long Term Stability	$T_A = 125^\circ C$ 1000Hrs		0.5		%

NOTE 1: See short-circuit current curve for available output current at fixed dropout.

Table 10: Electrical Characteristics Of LD1085CDT50 ($V_I=8V$, $C_I = C_O = 10\mu F$, $T_A = -40$ to $125^\circ C$, unless otherwise specified.)

Symbol	Parameter	Test Conditions	Min.	Typ.	Max.	Unit
V_O	Output Voltage	$I_O = 0 \text{ mA}$ $T_J = 25^\circ C$	4.9	5	5.1	V
		$I_O = 0$ to $3A$ $V_I = 6.6$ to $30V$ (note 1)	4.85	5	5.15	V
ΔV_O	Line Regulation	$I_O = 0 \text{ mA}$ $V_I = 6.6$ to $20V$ $T_J = 25^\circ C$		0.5	10	mV
		$I_O = 0 \text{ mA}$ $V_I = 6.6$ to $20V$		1	10	mV
ΔV_O	Load Regulation	$I_O = 0$ to $3A$ $T_J = 25^\circ C$		5	20	mV
		$I_O = 0$ to $3A$		10	35	V
V_d	Dropout Voltage	$I_O = 3 \text{ A}$		1.3	1.5	V
I_q	Quiescent Current	$V_I \leq 30V$		5	10	mA
I_{sc}	Short Circuit Current	$V_I - V_O = 5V$	3.2	4.5		A
		$V_I - V_O = 25V$	0.2	0.5		A
	Thermal Regulation	$T_A = 25^\circ C$, 30ms pulse		0.008	0.04	%/W
SVR	Supply Voltage Rejection	$f = 120 \text{ Hz}$, $C_O = 25 \mu F$, $I_O = 3A$ $V_I = 10 \pm 3V$	60	72		dB
eN	RMS Output Noise Voltage (% of V_O)	$T_A = 25^\circ C$ $f = 10\text{Hz}$ to 10KHz		0.003		%
S	Temperature Stability			0.5		%
S	Long Term Stability	$T_A = 125^\circ C$ 1000Hrs		0.5		%

NOTE 1: See short-circuit current curve for available output current at fixed dropout.

Table 11: Electrical Characteristics Of LD1085CDT80 ($V_I=11V$, $C_I = C_O = 10\mu F$, $T_A = -40$ to $125^\circ C$, unless otherwise specified.)

Symbol	Parameter	Test Conditions	Min.	Typ.	Max.	Unit
V_O	Output Voltage	$I_O = 0 \text{ mA}$ $T_J = 25^\circ C$	7.84	8	8.16	V
		$I_O = 0$ to $3A$ $V_I = 9.8$ to $30V$ (note 1)	7.76	8	8.24	V
ΔV_O	Line Regulation	$I_O = 0 \text{ mA}$ $V_I = 9.8$ to $20V$ $T_J = 25^\circ C$		1	18	mV
		$I_O = 0 \text{ mA}$ $V_I = 9.8$ to $20V$		2	18	mV
ΔV_O	Load Regulation	$I_O = 0$ to $3A$ $T_J = 25^\circ C$		8	30	mV
		$I_O = 0$ to $3A$		12	60	V
V_d	Dropout Voltage	$I_O = 3 \text{ A}$		1.3	1.5	V
I_q	Quiescent Current	$V_I \leq 30V$		5	10	mA
I_{sc}	Short Circuit Current	$V_I - V_O = 5V$	3.2	4.5		A
		$V_I - V_O = 25V$	0.2	0.5		A
	Thermal Regulation	$T_A = 25^\circ C$, 30ms pulse		0.008	0.04	%/W
SVR	Supply Voltage Rejection	$f = 120 \text{ Hz}$, $C_O = 25 \mu F$, $I_O = 3A$ $V_I = 13 \pm 3V$	54	71		dB
eN	RMS Output Noise Voltage (% of V_O)	$T_A = 25^\circ C$ $f = 10\text{Hz}$ to 10KHz		0.003		%
S	Temperature Stability			0.5		%
S	Long Term Stability	$T_A = 125^\circ C$ 1000Hrs		0.5		%

NOTE 1: See short-circuit current curve for available output current at fixed dropout.

Table 12: Electrical Characteristics Of LD1085CDT90 ($V_I=12V$, $C_I = C_O = 10\mu F$, $T_A = -40$ to $125^\circ C$, unless otherwise specified.)

Symbol	Parameter	Test Conditions	Min.	Typ.	Max.	Unit
V_O	Output Voltage	$I_O = 0 \text{ mA}$ $T_J = 25^\circ C$	8.82	9	9.18	V
		$I_O = 0$ to $3A$ $V_I = 11$ to $30V$ (note 1)	8.73	9	9.27	V
ΔV_O	Line Regulation	$I_O = 0 \text{ mA}$ $V_I = 11$ to $20V$ $T_J = 25^\circ C$		1	20	mV
		$I_O = 0 \text{ mA}$ $V_I = 11$ to $20V$		2	20	mV
ΔV_O	Load Regulation	$I_O = 0$ to $3A$ $T_J = 25^\circ C$		8	30	mV
		$I_O = 0$ to $3A$		12	60	V
V_d	Dropout Voltage	$I_O = 3 \text{ A}$		1.3	1.5	V
I_q	Quiescent Current	$V_I \leq 30V$		5	10	mA
I_{sc}	Short Circuit Current	$V_I - V_O = 5V$	5.5	6.5		A
		$V_I - V_O = 25V$	0.5	0.7		A
	Thermal Regulation	$T_A = 25^\circ C$, 30ms pulse		0.008	0.04	%/W
SVR	Supply Voltage Rejection	$f = 120 \text{ Hz}$, $C_O = 25 \mu F$, $I_O = 3A$ $V_I = 14 \pm 3V$	54	70		dB
eN	RMS Output Noise Voltage (% of V_O)	$T_A = 25^\circ C$ $f = 10\text{Hz}$ to 10KHz		0.003		%
S	Temperature Stability			0.5		%
S	Long Term Stability	$T_A = 125^\circ C$ 1000Hrs		0.5		%

NOTE 1: See short-circuit current curve for available output current at fixed dropout.

Table 13: Electrical Characteristics Of LD1085CDT12 ($V_I=15V$, $C_I = C_O = 10\mu F$, $T_A = -40$ to $125^\circ C$, unless otherwise specified.)

Symbol	Parameter	Test Conditions	Min.	Typ.	Max.	Unit
V_O	Output Voltage	$I_O = 0\text{ mA}$ $T_J = 25^\circ C$	11.76	12	12.24	V
		$I_O = 0$ to $3A$ $V_I = 13.8$ to $30V$ (note 1)	11.64	12	12.36	V
ΔV_O	Line Regulation	$I_O = 0\text{ mA}$ $V_I = 13.8$ to $25V$ $T_J = 25^\circ C$		1	25	mV
		$I_O = 0\text{ mA}$ $V_I = 13.8$ to $25V$		2	25	mV
ΔV_O	Load Regulation	$I_O = 0$ to $3A$ $T_J = 25^\circ C$		12	36	mV
		$I_O = 0$ to $3A$		24	72	V
V_d	Dropout Voltage	$I_O = 3\text{ A}$		1.3	1.5	V
I_q	Quiescent Current	$V_I \leq 30V$		5	10	mA
I_{sc}	Short Circuit Current	$V_I - V_O = 5V$	3.2	4.5		A
		$V_I - V_O = 25V$	0.2	0.5		A
	Thermal Regulation	$T_A = 25^\circ C$, 30ms pulse		0.008	0.04	%/W
SVR	Supply Voltage Rejection	$f = 120\text{ Hz}$, $C_O = 25\ \mu F$, $I_O = 3A$ $V_I = 17 \pm 3V$	54	66		dB
eN	RMS Output Noise Voltage (% of V_O)	$T_A = 25^\circ C$ $f = 10\text{Hz}$ to 10KHz		0.003		%
S	Temperature Stability			0.5		%
S	Long Term Stability	$T_A = 125^\circ C$ 1000Hrs		0.5		%

NOTE 1: See short-circuit current curve for available output current at fixed dropout.

Table 14: Electrical Characteristics Of LD1085CDT ($V_I=4.25V$, $C_I = C_O = 10\mu F$, $T_A = -40$ to $125^\circ C$, unless otherwise specified.)

Symbol	Parameter	Test Conditions	Min.	Typ.	Max.	Unit
V_O	Output Voltage	$I_O = 10\text{ mA}$ $T_J = 25^\circ C$	1.225	1.25	1.275	V
		$I_O = 10\text{ mA}$ to $5A$ $V_I = 2.85$ to $30V$ (note 1)	1.213	1.25	1.288	V
ΔV_O	Line Regulation	$I_O = 10\text{ mA}$ $V_I = 2.85$ to $16.5V$ $T_J = 25^\circ C$		0.015	0.2	%
		$I_O = 10\text{ mA}$ $V_I = 2.85$ to $16.5V$		0.035	0.2	%
ΔV_O	Load Regulation	$I_O = 10\text{ mA}$ to $5A$ $T_J = 25^\circ C$		0.1	0.3	%
		$I_O = 0$ to $5A$		0.2	0.4	%
V_d	Dropout Voltage	$I_O = 5A$		1.3	1.5	V
$I_{O(\min)}$	Minimum Load Current	$V_I = 30V$		3	10	mA
I_{sc}	Short Circuit Current	$V_I - V_O = 5V$	3.2	4.5		A
		$V_I - V_O = 25V$	0.2	0.5		A
	Thermal Regulation	$T_A = 25^\circ C$, 30ms pulse		0.003	0.015	%/W
SVR	Supply Voltage Rejection	$f = 120\text{ Hz}$, $C_O = 25\ \mu F$, $C_{ADJ} = 25\ \mu F$, $I_O = 5A$ $V_I = 6.25 \pm 3V$	60	75		dB
I_{ADJ}	Adjust Pin Current	$V_I = 4.25V$ $I_O = 10\text{ mA}$		55	120	μA
ΔI_{ADJ}	Adjust Pin Current Change	$I_O = 10\text{ mA}$ to $5A$ $V_I = 2.75$ to $16.5V$ (note 1)		0.2	5	μA
eN	RMS Output Noise Voltage (% of V_O)	$T_A = 25^\circ C$ $f = 10\text{Hz}$ to 10KHz		0.003		%
S	Temperature Stability			0.5		%
S	Long Term Stability	$T_A = 125^\circ C$ 1000Hrs		0.5		%

NOTE 1: See short-circuit current curve for available output current at fixed dropout.

TYPICAL CHARACTERISTICS (unless otherwise specified $T_j = 25^\circ\text{C}$, $C_i=C_o=10\mu\text{F}$)

Figure 4: Output Voltage vs Temperature

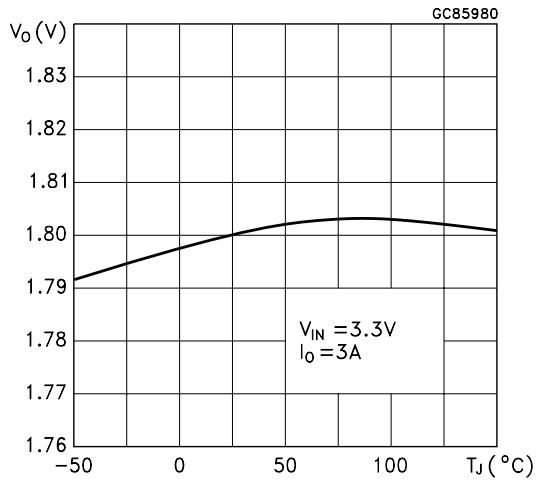

Figure 5: Output Voltage vs Temperature

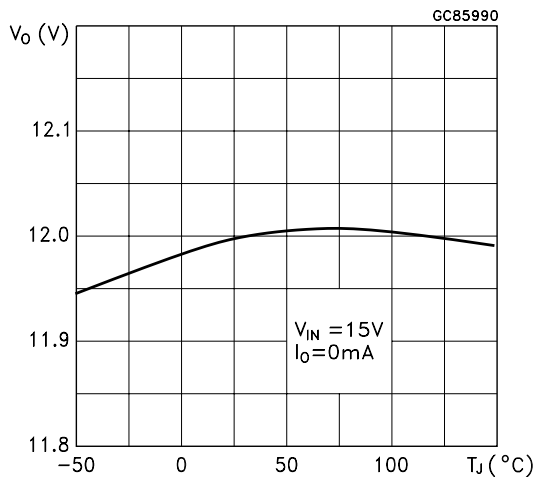

Figure 6: Output Voltage vs Temperature

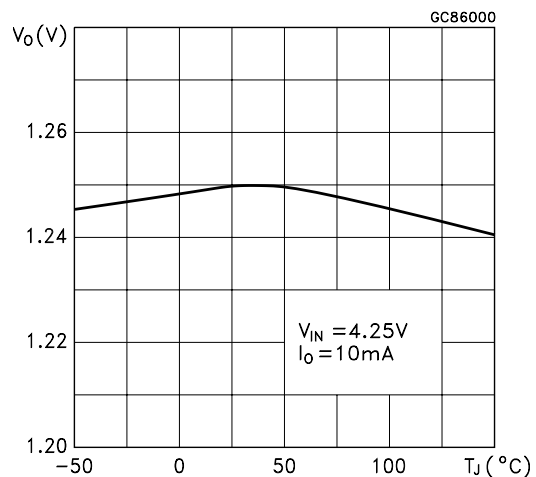

Figure 7: Short Circuit Current vs Dropout Voltage

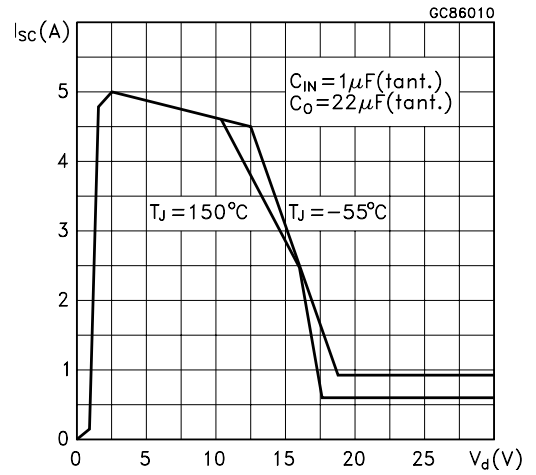

Figure 8: Line Regulation vs Temperature

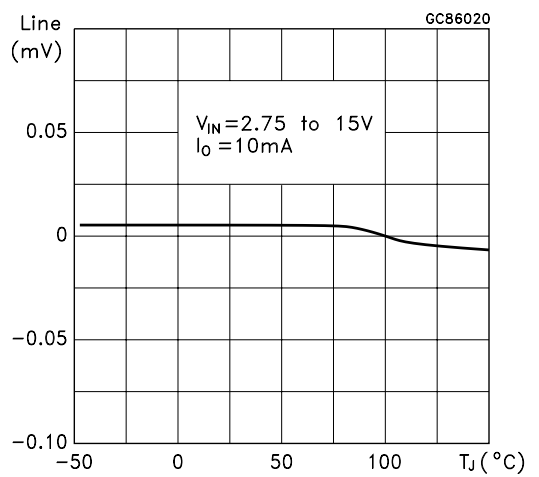

Figure 9: Load Regulation vs Temperature

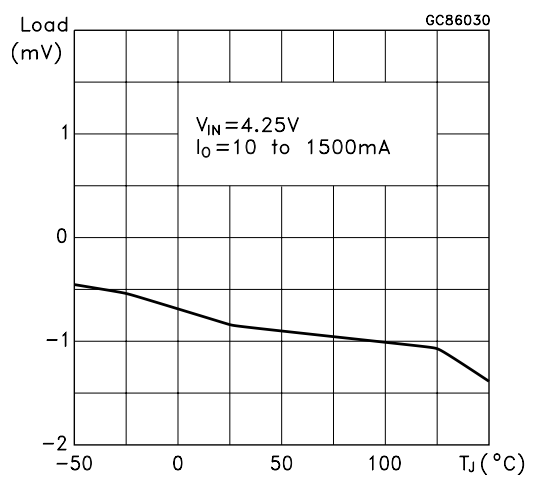

Figure 10: Dropout Voltage vs Temperature

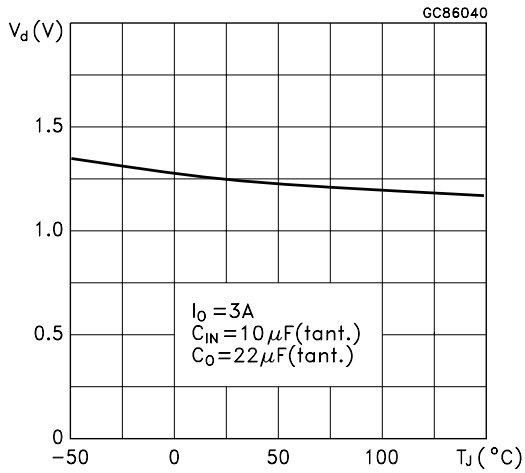

Figure 13: Quiescent Current vs Temperature

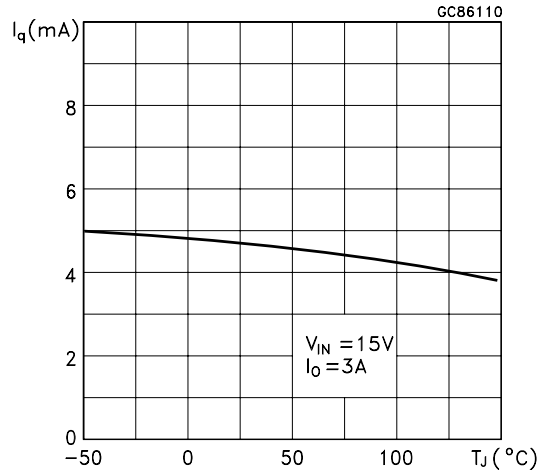

Figure 11: Dropout Voltage vs Output Current

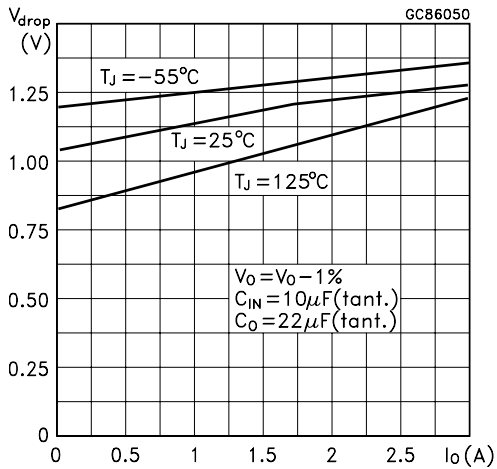

Figure 14: Dropout Voltage vs Output Current

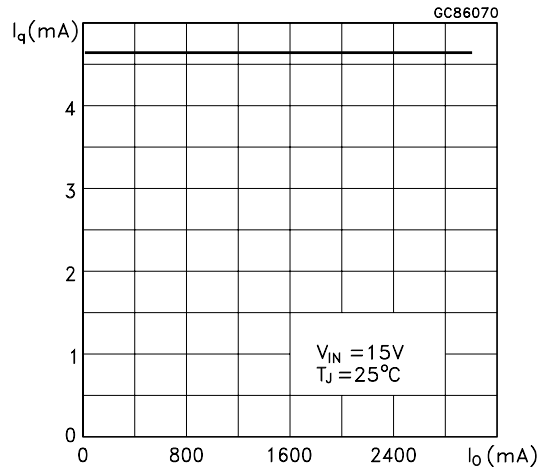

Figure 12: Adjust Pin Current vs Temperature

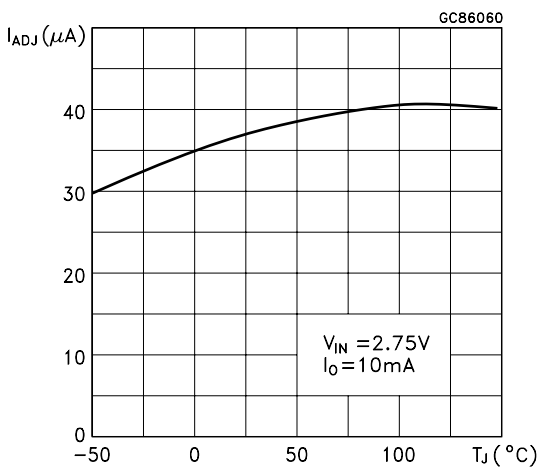

Figure 15: Supply Voltage Rejection vs Output Current

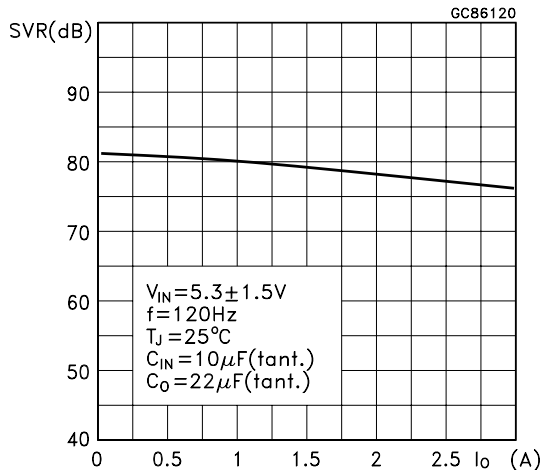

Figure 16: Supply Voltage Rejection vs Frequency

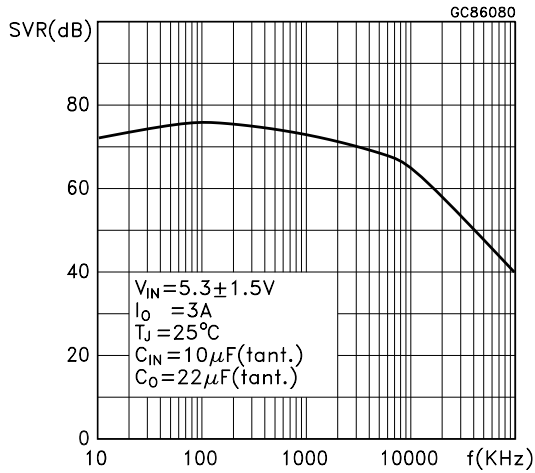

Figure 19: Stability

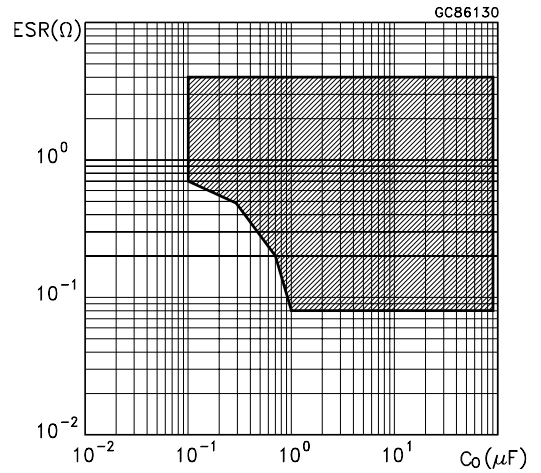

Figure 17: Supply Voltage Rejection vs Temperature

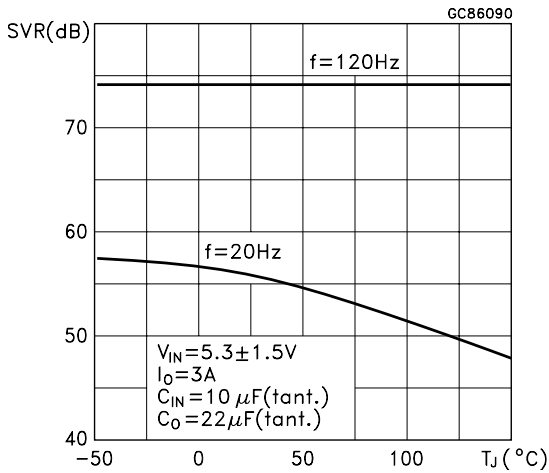

Figure 20: Stability

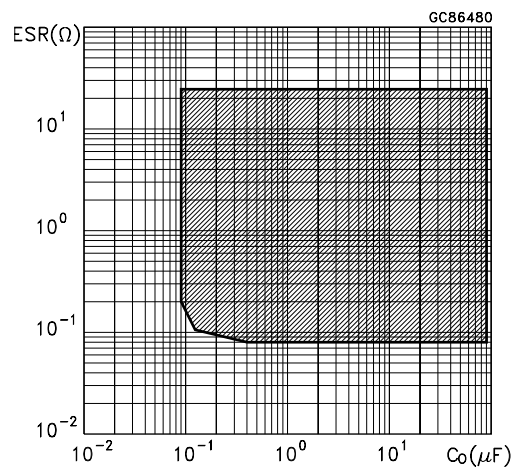

Figure 18: Minimum Load Current vs Temperature

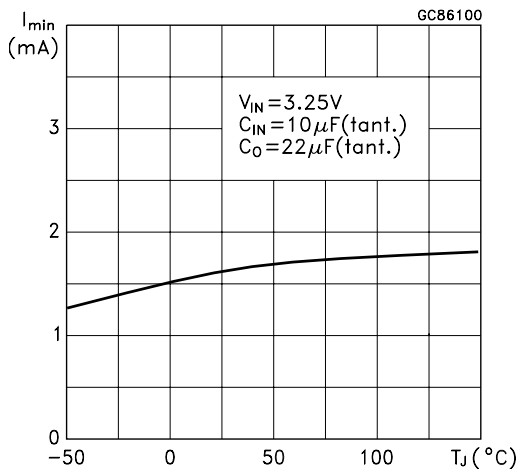

Figure 21: Line Transient

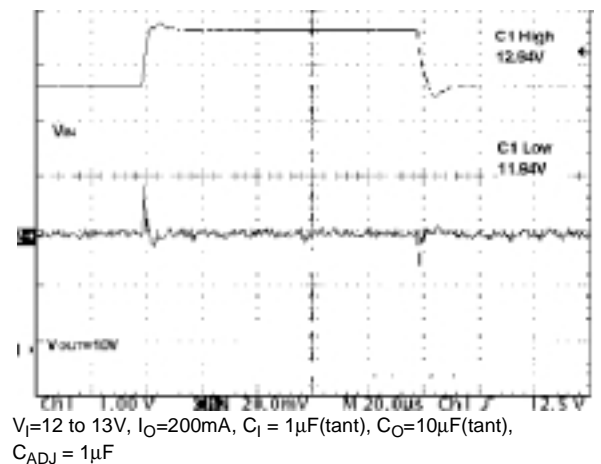
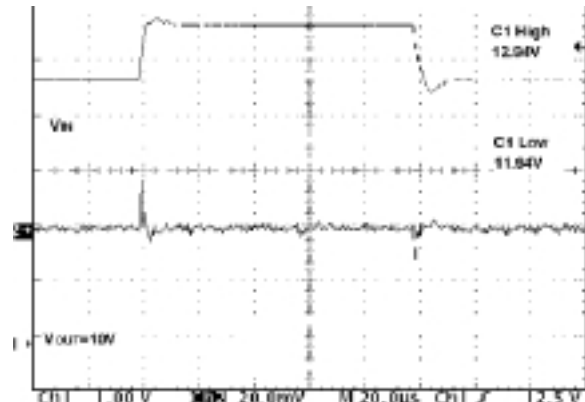
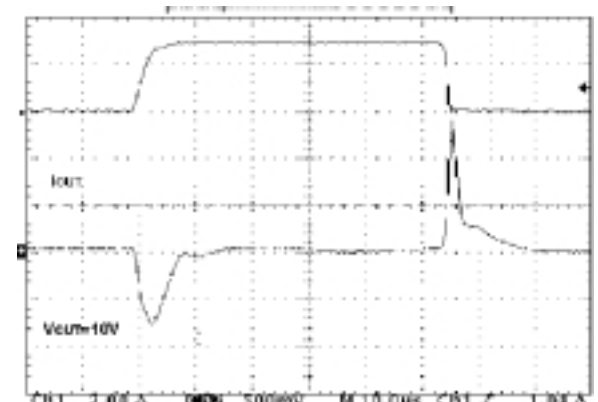

Figure 22: Line Transient



$V_I=12$ to 13 V, $I_O=200$ mA, $C_I=1\mu$ F(tant), $C_O=10\mu$ F(tant), $C_{ADJ}=1\mu$ F

Figure 24: Load Transient



$V_I=12$ V, $I_O=0.12$ to 3 A, $C_I=1\mu$ F(tant), $C_O=10\mu$ F(tant), $C_{ADJ}=1\mu$ F

Figure 23: Load Transient

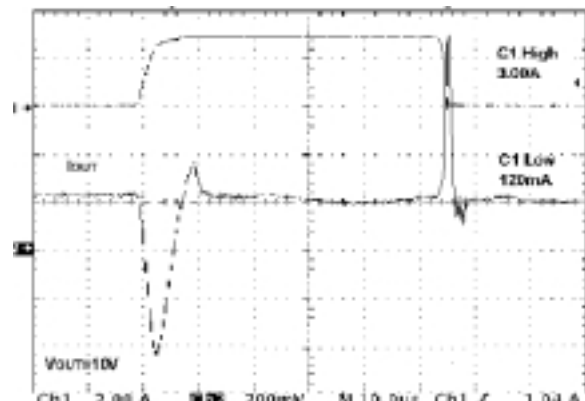

$V_I=12$ V, $I_O=0.12$ to 3 A, $C_I=1\mu$ F(tant), $C_O=10\mu$ F(tant), $C_{ADJ}=1\mu$ F

DPAK MECHANICAL DATA

DIM.	mm.			inch		
	MIN.	TYP	MAX.	MIN.	TYP.	MAX.
A	2.2		2.4	0.086		0.094
A1	0.9		1.1	0.035		0.043
A2	0.03		0.23	0.001		0.009
B	0.64		0.9	0.025		0.035
B2	5.2		5.4	0.204		0.212
C	0.45		0.6	0.017		0.023
C2	0.48		0.6	0.019		0.023
D	6		6.2	0.236		0.244
D1		5.1			0.200	
E	6.4		6.6	0.252		0.260
E1		4.7			0.185	
e		2.28			0.090	
e1	4.4		4.6	0.173		0.181
H	9.35		10.1	0.368		0.397
L	1			0.039		
(L1)		2.8			0.110	
L2		0.8			0.031	
L4	0.6		1	0.023		0.039

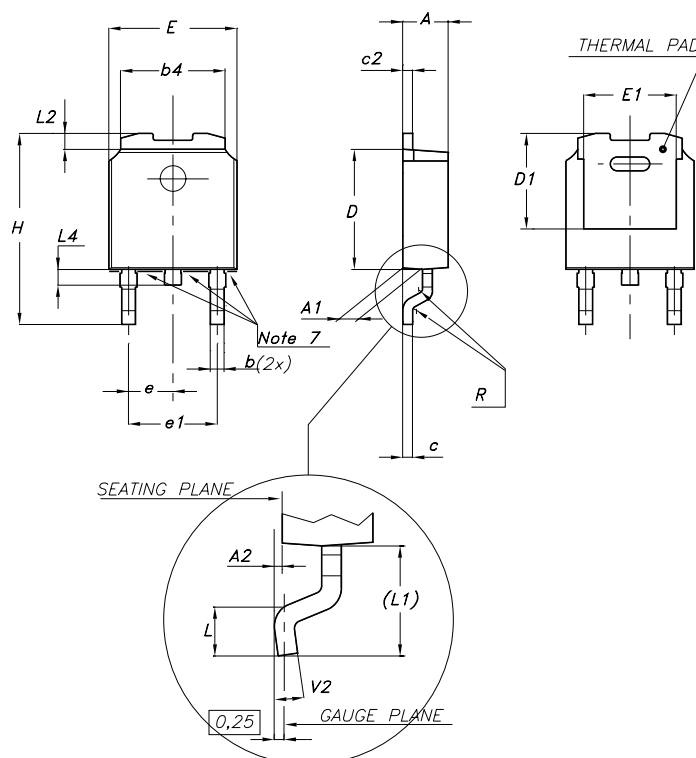

0068772-F

Tape & Reel DPAK-PPAK MECHANICAL DATA

DIM.	mm.			inch		
	MIN.	TYP	MAX.	MIN.	TYP.	MAX.
A			330			12.992
C	12.8	13.0	13.2	0.504	0.512	0.519
D	20.2			0.795		
N	60			2.362		
T			22.4			0.882
Ao	6.80	6.90	7.00	0.268	0.272	0.276
Bo	10.40	10.50	10.60	0.409	0.413	0.417
Ko	2.55	2.65	2.75	0.100	0.104	0.105
Po	3.9	4.0	4.1	0.153	0.157	0.161
P	7.9	8.0	8.1	0.311	0.315	0.319

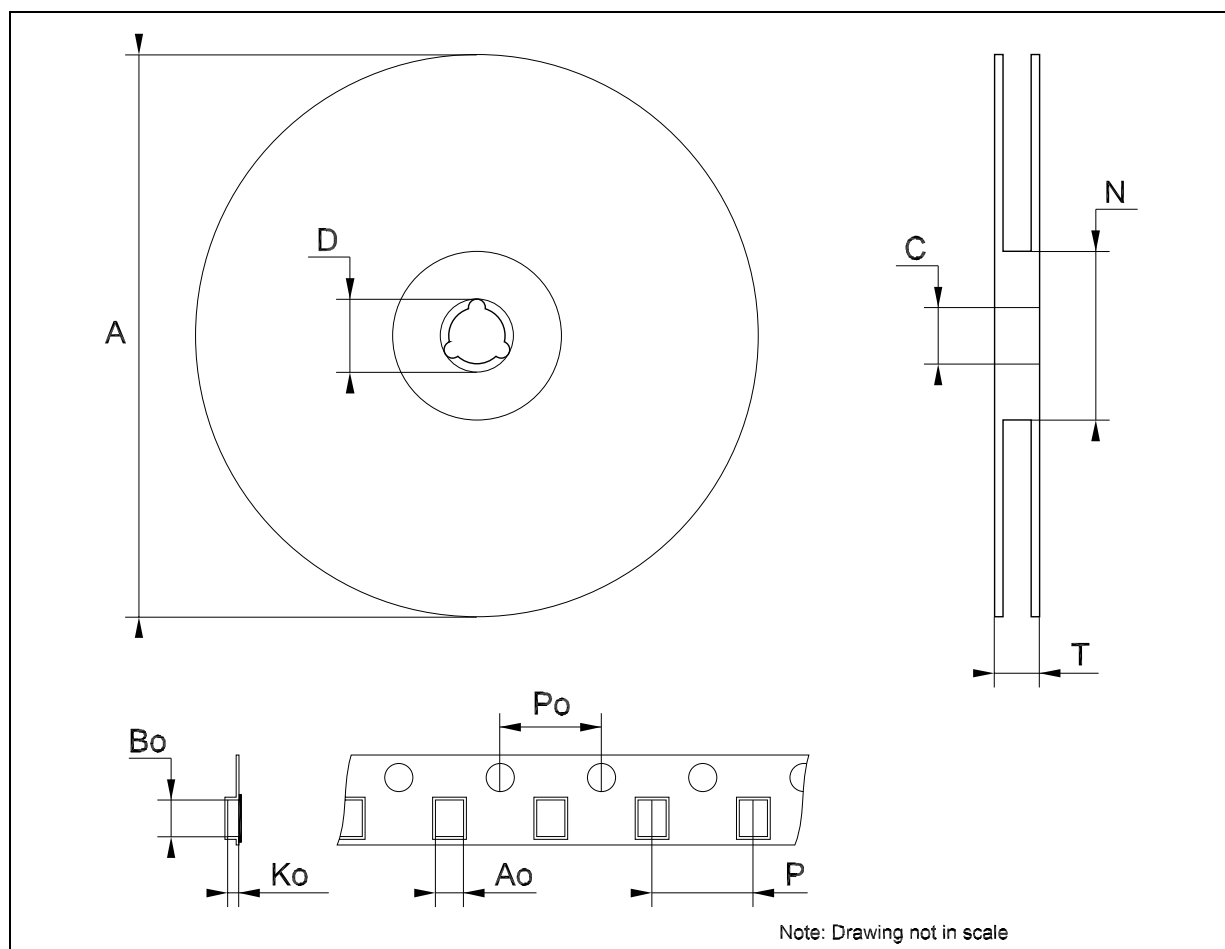

Table 15: Revision History

Date	Revision	Description of Changes
07-Oct-2004	6	Mistake Order Codes - Table 1.

Information furnished is believed to be accurate and reliable. However, STMicroelectronics assumes no responsibility for the consequences of use of such information nor for any infringement of patents or other rights of third parties which may result from its use. No license is granted by implication or otherwise under any patent or patent rights of STMicroelectronics. Specifications mentioned in this publication are subject to change without notice. This publication supersedes and replaces all information previously supplied. STMicroelectronics products are not authorized for use as critical components in life support devices or systems without express written approval of STMicroelectronics.

The ST logo is a registered trademark of STMicroelectronics

All other names are the property of their respective owners

© 2004 STMicroelectronics - All Rights Reserved

STMicroelectronics group of companies

Australia - Belgium - Brazil - Canada - China - Czech Republic - Finland - France - Germany - Hong Kong - India - Israel - Italy - Japan - Malaysia - Malta - Morocco - Singapore - Spain - Sweden - Switzerland - United Kingdom - United States of America

www.st.com