

GENERAL DESCRIPTION

The 8304-01 is a low skew, 1-to-4 Inverting Fanout Buffer. The 8304-01 is characterized at full 3.3V for input V_{DD} , and mixed 3.3V and 2.5V for output operating supply modes (V_{DDO}). Guaranteed output and part-to-part skew characteristics make the 8304-01 ideal for those clock distribution applications demanding well defined performance and repeatability.

FEATURES

- 4 LVCMOS / LVTTL outputs
- LVCMOS/LVTTL clock input
- Maximum output frequency: 166MHz
- Output skew: 50ps (maximum)
- Part-to-part skew: 600ps (maximum)
- Small 8 lead SOIC package saves board space
- 3.3V input, outputs may be either 3.3V or 2.5V supply modes
- 0°C to 70°C ambient operating temperature
- Lead-Free package fully RoHS compliant
- **For functional replacement part use 8304AMLF**

BLOCK DIAGRAM

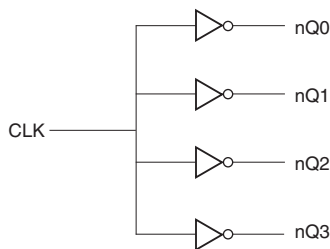

PIN ASSIGNMENT

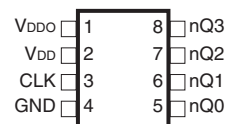

8304-01
8-Lead SOIC
 3.8mm x 4.8mm x 1.47mm package body
M Package
 Top View

TABLE 1. PIN DESCRIPTIONS

Number	Name	Type		Description
1	V_{DDO}	Power		Output supply pin.
2	V_{DD}	Power		Core supply pin.
3	CLK	Input	Pulldown	LVC MOS / LV TTL clock input.
4	GND	Power		Power supply ground.
5	nQ0	Output		Inverted version of clock input. LVC MOS / LV TTL interface levels.
6	nQ1	Output		Inverted version of clock input. LVC MOS / LV TTL interface levels.
7	nQ2	Output		Inverted version of clock input. LVC MOS / LV TTL interface levels.
8	nQ3	Output		Inverted version of clock input. LVC MOS / LV TTL interface levels.

NOTE: *Pulldown* refers to internal input resistors. See Table 2, Pin Characteristics, for typical values.

TABLE 2. PIN CHARACTERISTICS

Symbol	Parameter	Test Conditions	Minimum	Typical	Maximum	Units
C_{IN}	Input Capacitance			4		pF
C_{PD}	Power Dissipation Capacitance (per output)	$V_{DD}, V_{DDO} = 3.465V$			15	pF
$R_{PULLDOWN}$	Input Pulldown Resistor			51		k Ω
R_{OUT}	Output Impedance			7		Ω

ABSOLUTE MAXIMUM RATINGS

Supply Voltage, V_{DDx}	4.6V
Inputs, V_{DD}	-0.5V to $V_{DD} + 0.5V$
Outputs, V_{DDO}	-0.5V to $V_{DDO} + 0.5V$
Package Thermal Impedance, θ_{JA}	112.7°C/W (0 lfpm)
Storage Temperature, T_{STG}	-65°C to 150°C

NOTE: Stresses beyond those listed under Absolute Maximum Ratings may cause permanent damage to the device. These ratings are stress specifications only. Functional operation of product at these conditions or any conditions beyond those listed in the *DC Characteristics* or *AC Characteristics* is not implied. Exposure to absolute maximum rating conditions for extended periods may affect product reliability.

TABLE 3A. POWER SUPPLY DC CHARACTERISTICS, $V_{DD} = V_{DDO} = 3.3V \pm 5\%$, $T_A = 0^\circ C$ TO $70^\circ C$

Symbol	Parameter	Test Conditions	Minimum	Typical	Maximum	Units
V_{DD}	Core Supply Voltage		3.135	3.3	3.465	V
V_{DDO}	Output Power Supply Voltage		3.135	3.3	3.465	V
I_{DD}	Power Supply Current				15	mA
I_{DDO}	Output Supply Current				8	mA

TABLE 3B. LVCMOS / LVTTTL DC CHARACTERISTICS, $V_{DD} = V_{DDO} = 3.3V \pm 5\%$, $T_A = 0^\circ C$ TO $70^\circ C$

Symbol	Parameter	Test Conditions	Minimum	Typical	Maximum	Units
V_{IH}	Input High Voltage		2		$V_{DD} + 0.3$	V
V_{IL}	Input Low Voltage		-0.3		1.3	V
I_{IH}	Input High Current	$V_{DD} = V_{IN} = 3.465V$			150	μA
I_{IL}	Input Low Current	$V_{DD} = 3.465V, V_{IN} = 0V$	-5			μA
V_{OH}	Output High Voltage; NOTE 1		2.6			V
V_{OL}	Output Low Voltage; NOTE 1				0.5	V

NOTE 1: Outputs terminated with 50 to $V_{DDO}/2$. See Parameter Measurement Information Section, "3.3V Output Load Test Circuit".

TABLE 4A. AC CHARACTERISTICS, $V_{DD} = V_{DDO} = 3.3V \pm 5\%$, $T_A = 0^\circ C$ TO $70^\circ C$

Symbol	Parameter	Test Conditions	Minimum	Typical	Maximum	Units
f_{MAX}	Output Frequency				166	MHz
t_{PD}	Propagation Delay; NOTE 1	$f \leq 166MHz$	2.3		3.5	ns
tsk(o)	Output Skew; NOTE 2, 4				50	ps
tsk(pp)	Part-to-Part Skew; NOTE 3, 4				600	ps
t_R	Output Rise Time	30% to 70%	250		500	ps
t_F	Output Fall Time	30% to 70%	250		500	ps
odc	Output Duty Cycle	$f \leq 166MHz$	40		60	%

All parameters measured at 166MHz unless noted otherwise.

NOTE 1: Measured from $V_{DD}/2$ of the input to $V_{DDO}/2$ of the output. Measured from the rising edge of the input to the falling edge of the output.

NOTE 2: Defined as skew between outputs at the same supply voltage and with equal load conditions. Measured at $V_{DDO}/2$.

NOTE 3: Defined as skew between outputs on different devices operating at the same supply voltages and with equal load conditions. Using the same type of inputs on each device, the outputs are measured at $V_{DDO}/2$.

NOTE 4: This parameter is defined in accordance with JEDEC Standard 65.

TABLE 3C. POWER SUPPLY DC CHARACTERISTICS, $V_{DD} = 3.3V \pm 5\%$, $V_{DDO} = 2.5V \pm 5\%$, $T_A = 0^\circ C$ TO $70^\circ C$

Symbol	Parameter	Test Conditions	Minimum	Typical	Maximum	Units
V_{DD}	Core Supply Voltage		3.135	3.3	3.465	V
V_{DDO}	Output Supply Voltage		2.375	2.5	2.625	V
I_{DD}	Power Supply Current				15	mA
I_{DDO}	Output Supply Current				8	mA

TABLE 3D. LVCMOS / LVTTTL DC CHARACTERISTICS, $V_{DD} = 3.3V \pm 5\%$, $V_{DDO} = 2.5V \pm 5\%$, $T_A = 0^\circ C$ TO $70^\circ C$

Symbol	Parameter	Test Conditions	Minimum	Typical	Maximum	Units
V_{IH}	Input High Voltage		2		$V_{DD} + 0.3$	V
V_{IL}	Input Low Voltage		-0.3		1.3	V
I_{IH}	Input High Current	$V_{DD} = V_{IN} = 3.465V$			150	μA
I_{IL}	Input Low Current	$V_{DD} = 3.465V, V_{IN} = 0V$	-5			μA
V_{OH}	Output High Voltage; NOTE 1		2.1			V
V_{OL}	Output Low Voltage; NOTE 1				0.5	V

NOTE 1: Outputs terminated with 50Ω to $V_{DDO}/2$. See Parameter Measurement Information Section, "3.3V/2.5V Output Load Test Circuit".

TABLE 4B. AC CHARACTERISTICS, $V_{DD} = 3.3V \pm 5\%$, $V_{DDO} = 2.5V \pm 5\%$, $T_A = 0^\circ C$ TO $70^\circ C$

Symbol	Parameter	Test Conditions	Minimum	Typical	Maximum	Units
f_{MAX}	Maximum Output Frequency				166	MHz
t_{PD}	Propagation Delay; NOTE 1	$f \leq 166MHz$	2.5		3.6	ns
tsk(o)	Output Skew; NOTE 2, 4				50	ps
tsk(pp)	Part-to-Part Skew; NOTE 3, 4				600	ps
t_R	Output Rise Time	30% to 70%	250		500	ps
t_F	Output Fall Time	30% to 70%	250		500	ps
odc	Output Duty Cycle	$f \leq 166MHz$	40		60	%

All parameters measured at 166MHz unless noted otherwise.

NOTE 1: Measured from $V_{DD}/2$ of the input to $V_{DDO}/2$ of the output. Measured from the rising edge of the input to the falling edge of the output.

NOTE 2: Defined as skew between outputs at the same supply voltage and with equal load conditions. Measured at $V_{DDO}/2$.

NOTE 3: Defined as skew between outputs on different devices operating at the same supply voltages and with equal load conditions. Using the same type of inputs on each device, the outputs are measured at $V_{DDO}/2$.

NOTE 4: This parameter is defined in accordance with JEDEC Standard 65.

PARAMETER MEASUREMENT INFORMATION

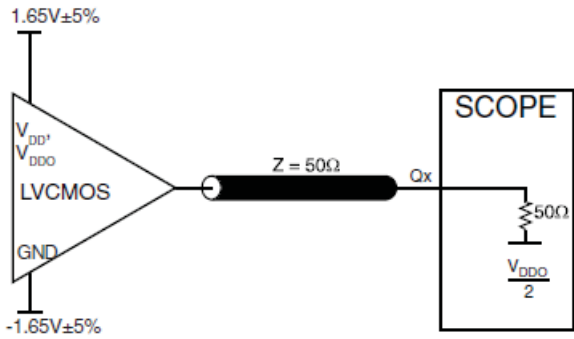

3.3V OUTPUT LOAD AC TEST CIRCUIT

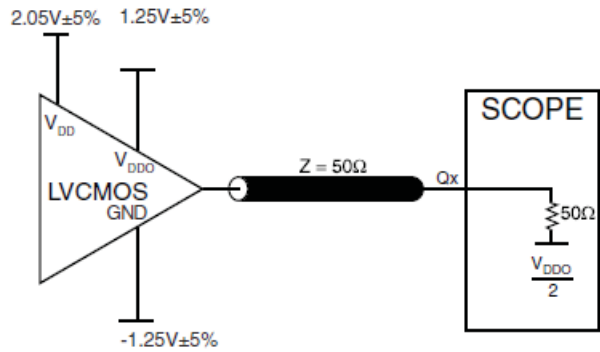

3.3V/2.5V OUTPUT LOAD AC TEST CIRCUIT



OUTPUT SKEW



PART-TO-PART SKEW

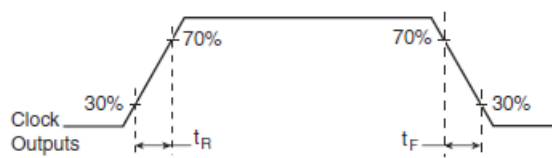

OUTPUT RISE/FALL TIME

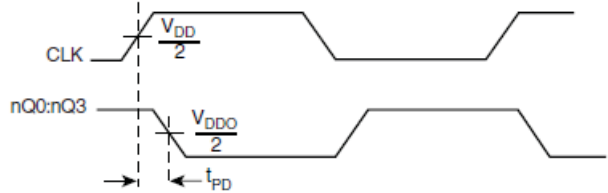

PROPAGATION DELAY

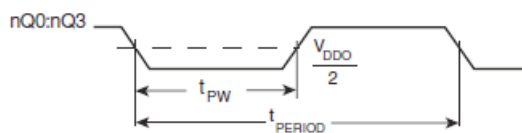

OUTPUT DUTY CYCLE/PULSE WIDTH/PERIOD

RELIABILITY INFORMATION

TABLE 5. θ_{JA} VS. AIR FLOW TABLE FOR 8 LEAD SOIC

θ_{JA} by Velocity (Linear Feet per Minute)			
	0	200	500
Single-Layer PCB, JEDEC Standard Test Boards	153.3°C/W	128.5°C/W	115.5°C/W
Multi-Layer PCB, JEDEC Standard Test Boards	112.7°C/W	103.3°C/W	97.1°C/W

NOTE: Most modern PCB designs use multi-layered boards. The data in the second row pertains to most designs.

TRANSISTOR COUNT

The transistor count for 8304-01 is: 416

PACKAGE OUTLINE - SUFFIX M FOR 8 LEAD SOIC

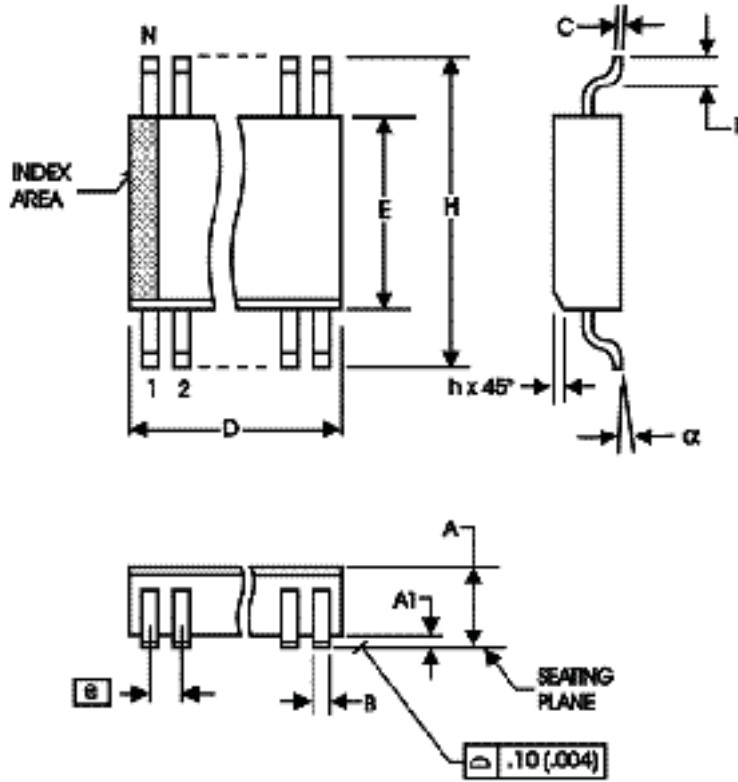

TABLE 6. PACKAGE DIMENSIONS - SUFFIX M

SYMBOL	Millimeters	
	MINIMUM	MAXIMUM
N	8	
A	1.35	1.75
A1	0.10	0.25
B	0.33	0.51
C	0.19	0.25
D	4.80	5.00
E	3.80	4.00
e	1.27 BASIC	
H	5.80	6.20
h	0.25	0.50
L	0.40	1.27
α	0°	8°

Reference Document: JEDEC Publication 95, MS-012

TABLE 6. ORDERING INFORMATION

Part/Order Number	Marking	Package	Shipping Packaging	Temperature
8304AM-01LF	8304A01L	8 lead "Lead-Free" SOIC	tube	0°C to 70°C
8304AM-01LFT	8304A01L	8 lead "Lead-Free" SOIC	tape & reel	0°C to 70°C

NOTE: Parts that are ordered with an "LF" suffix to the part number are the Pb-Free configuration and are RoHS compliant.

REVISION HISTORY SHEET				
Rev	Table	Page	Description of Change	Date
B	4A	3	AC Characteristics Table - revised t_{pLH} row to t_{pD} and revised NOTE 1.	4/9/02
	4B	4	Deleted t_{pHL} row.	
	6 & 7	4	AC Characteristics Table - revised t_{pLH} row to t_{pD} and revised NOTE 1. Deleted t_{pHL} row. Updated Figures.	
C	4A	3	AC Characteristics Table - changed $t_{sk(pp)}$ Part-to-Part Skew from 250ps Max. to 600ps Max.	5/20/02
	4B	4	AC Characteristics Table - changed $t_{sk(pp)}$ Part-to-Part Skew from 250ps Max. to 600ps Max.	
C	6	10	Ordering Information, updated marking from 8304-01 to 8304AM01	6/17/02
D	T1	2	Pin Descripton Table - revised V_{DD} description to read "Core supply pin." (Also changed in Power Supply tables.) Deleted Pullup from note.	3/1/04
	T2	2	Pin Characteristics Table - C_{IN} changed 4pF max. to 4pF typical. Deleted R_{PULLUP} row.	
	T6	10	Ordering Information Table - changed Part/Order number ICS8304M-01/-01T to ICS8304AM-01/-01T. Updated format throughout data sheet.	
D	T6	1	Features Section - added Lead-Free bullet.	5/23/05
		8	Ordering Information Table - add Lead-Free parts.	
D	T6	8	Updated datasheet's header/footer with IDT from ICS.	7/29/10
		10	Removed ICS prefix from Part/Order Number column. Added Contact Page.	
D	T6	8	Ordering Information - removed leaded devices. Updated data sheet format.	3/19-15
D			Product Discontinuation Notice - ILast time buy expires May 6, 2017. PDN CQ-16-01.	5/9/16

IMPORTANT NOTICE AND DISCLAIMER

RENESAS ELECTRONICS CORPORATION AND ITS SUBSIDIARIES (“RENESAS”) PROVIDES TECHNICAL SPECIFICATIONS AND RELIABILITY DATA (INCLUDING DATASHEETS), DESIGN RESOURCES (INCLUDING REFERENCE DESIGNS), APPLICATION OR OTHER DESIGN ADVICE, WEB TOOLS, SAFETY INFORMATION, AND OTHER RESOURCES “AS IS” AND WITH ALL FAULTS, AND DISCLAIMS ALL WARRANTIES, EXPRESS OR IMPLIED, INCLUDING, WITHOUT LIMITATION, ANY IMPLIED WARRANTIES OF MERCHANTABILITY, FITNESS FOR A PARTICULAR PURPOSE, OR NON-INFRINGEMENT OF THIRD PARTY INTELLECTUAL PROPERTY RIGHTS.

These resources are intended for developers skilled in the art designing with Renesas products. You are solely responsible for (1) selecting the appropriate products for your application, (2) designing, validating, and testing your application, and (3) ensuring your application meets applicable standards, and any other safety, security, or other requirements. These resources are subject to change without notice. Renesas grants you permission to use these resources only for development of an application that uses Renesas products. Other reproduction or use of these resources is strictly prohibited. No license is granted to any other Renesas intellectual property or to any third party intellectual property. Renesas disclaims responsibility for, and you will fully indemnify Renesas and its representatives against, any claims, damages, costs, losses, or liabilities arising out of your use of these resources. Renesas' products are provided only subject to Renesas' Terms and Conditions of Sale or other applicable terms agreed to in writing. No use of any Renesas resources expands or otherwise alters any applicable warranties or warranty disclaimers for these products.

(Rev.1.0 Mar 2020)

Corporate Headquarters

TOYOSU FORESIA, 3-2-24 Toyosu,
Koto-ku, Tokyo 135-0061, Japan
www.renesas.com

Contact Information

For further information on a product, technology, the most up-to-date version of a document, or your nearest sales office, please visit:
www.renesas.com/contact/

Trademarks

Renesas and the Renesas logo are trademarks of Renesas Electronics Corporation. All trademarks and registered trademarks are the property of their respective owners.