

# SRAM

# 32K X 8 HIGH SPEED CMOS STATIC RAM

## FEATURES

- High speed access time: 7/8/10/12/15ns(max.)
- Low power consumption : Active 300 mW (typ.)
- Single + 5 power supply
- Fully static operation – No clock or refreshing required
- All inputs and outputs directly TTL compatible
- Common I/O capability
- Available packages : 28-pin 300 mil SOJ and TSOP-I (forward type ).
- Output enable ( $\overline{OE}$ ) available for very fast access
- Mix-mode Outputs

## PIN CONFIGURATION

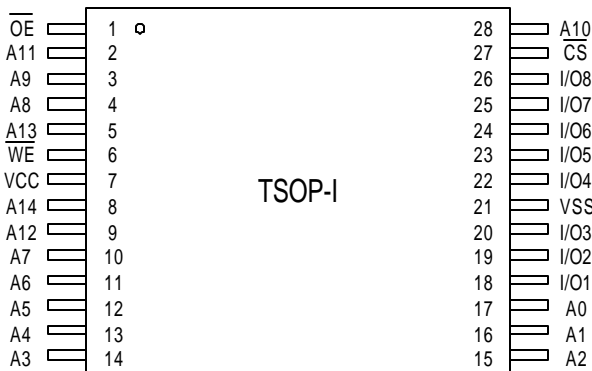
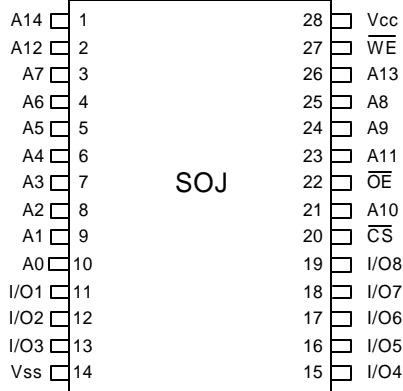

## GENERAL DESCRIPTION

The T14M256A is a high speed, low power CMOS static RAM organized as 32,768 x 8 bits that operates on a single 5-volt power supply. This device is packaged in a standard 28-pin 300 mil SOJ or TSOP-I forward.

## BLOCK DIAGRAM

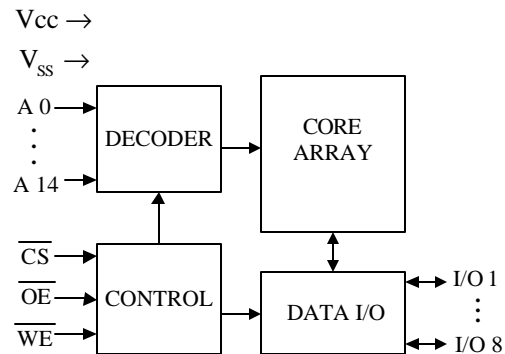

## PIN DESCRIPTION

SYMBOL	DESCRIPTION
A0 - A14	Address Inputs
I/O1 - I/O8	Data Inputs/Outputs
$\overline{CS}$	Chip Select Inputs
$\overline{WE}$	Write Enable
$\overline{OE}$	Output Enable
Vcc	Power Supply
Vss	Ground

## PART NUMBER EXAMPLES

PART NO.	PACKAG E CODE	SPEED	Operating Temperature
T 14M256 A-8J	S=SOJ	8ns	0 ~ +70 °C
T 14M256 A-8P	P=TSOP-I		
T 14M256 A-8JE	S=SOJ	8ns	-20 ~ +70 °C
T 14M256 A-8PE	P=TSOP-I		

**DC CHARACTERISTICS ABSOLUTE MAXIMUM RATINGS**

PARAMETER	RATING	UNIT
Supply Voltage to Vss Potential	-0.5 to + 6	V
Inputs to Vss Potential	-0.5 to Vcc +0.5	V
Power Dissipation	1.0	W
Storage Temperature	-60 to +150	°C

**RECOMMENDED OPERATING CONDITIONS**

PARAMETER	SYM	MIN	TYP	MAX	UNIT
Supply Voltage	Vcc	Typ-5%	5	Typ+5%	V
Input Voltage, low	V <sub>IL</sub>	-0.3	-	0.8	V
Input Voltage, high	V <sub>IH</sub>	2.2	-	Vcc+0.3	V
Ambient Temperature	T <sub>A</sub>	0	-	70	°C

**Note:** V<sub>IL</sub> (min.) = -2.0V for pulse width ≤ 20ns, V<sub>IH</sub> (max.) = +7.0V for pulse width ≤ 20ns.

**TRUTH TABLE**

CS	OE	WE	MODE	I/O1- I/O8	Vcc
H	X	X	Not Selected	High-Z	I <sub>SB</sub> , I <sub>SBI</sub>
L	H	H	Output Disable	High-Z	Icc
L	L	H	Read	Data Out	Icc
L	X	L	Write	Data In	Icc

**OPERATING CHARACTERISTICS**

(Vcc = 5V ± 5%, Vss = 0V, Ta = 0 to 70°C)

PARAMETER	SYM.	TEST CONDITIONS	MIN.	TYP.	MAX.	UNIT	
Input Leakage Current	I <sub>LI</sub>	Vin=Vss to Vcc	-10	-	+10	uA	
Output Leakage Current	I <sub>LO</sub>	V <sub>I/O</sub> =Vss to Vcc, CS = V <sub>IH</sub> or OE= V <sub>IH</sub> or WE = V <sub>IL</sub>	-10	-	+10	uA	
Output Low Voltage	V <sub>OL</sub>	I <sub>OL</sub> = + 8.0mA	-	-	0.4	V	
Output High Voltage	V <sub>OH</sub>	I <sub>OH</sub> = - 4.0mA	2.4	-	-	V	
Operating Power Supply Current	Icc	CS = V <sub>IL</sub> , I/O=0mA Cycle = MIN. Duty = 100%	-7	-	-	125	mA
			-8	-	-	120	mA
			-10	-	-	110	mA
			-12	-	-	100	mA
			-15	-	-	90	mA
Standby Power Supply Current	I <sub>SB</sub>	CS = V <sub>IH</sub> , Cycle=MIN, Duty=100%	-	-	15	mA	
	I <sub>SBI</sub>	CS ≥ Vcc-0.2V	-	-	2	mA	

**Note:** Typical characteristics are at Vcc = 5V, Ta = 25°C

**CAPACITANCE**

(V<sub>CC</sub> = 5V, T<sub>a</sub> = 25°C, f = 1 MHz)

PARAMETER	SYMBOL	CONDITION	MAX.	UNIT
Input Capacitance	C <sub>IN</sub>	V <sub>IN</sub> = 0V	6	pF
Input/ Output Capacitance	C <sub>I/O</sub>	V <sub>OUT</sub> = 0V	8	pF

**Note:** These parameters are sampled but not 100% tested.

**AC TEST CONDITIONS**

PARAMETER	CONDITIONS
Input Pulse Levels	0V to 3V
Input Rise and Fall Times	3 ns
Input and Output Timing Reference Level	1.5V
Output Load	C <sub>L</sub> = 30pF, I <sub>OH</sub> /I <sub>OL</sub> = -4mA/8mA

**AC TEST LOADS AND WAVEFORM**

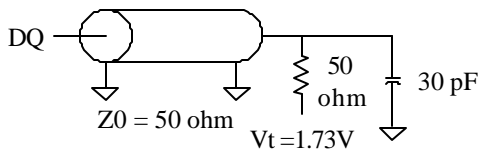

Fig.1

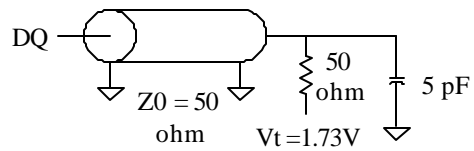

Fig.3

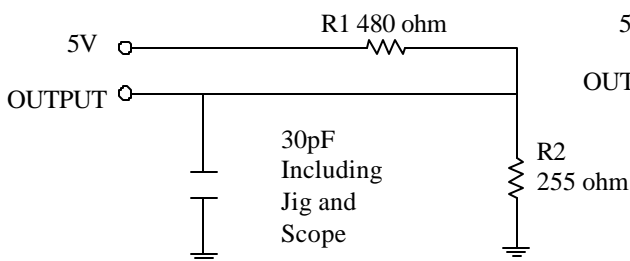

Fig.2

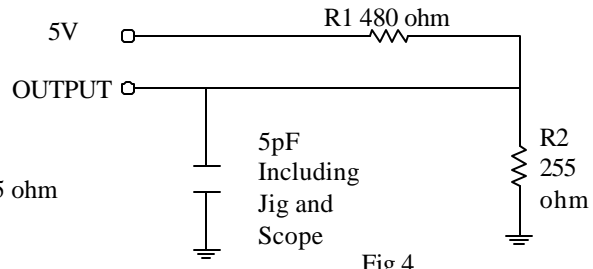

Fig.4

(For TCLZ, TOLZ, TCHZ, TOHZ, TWHZ, TOW )

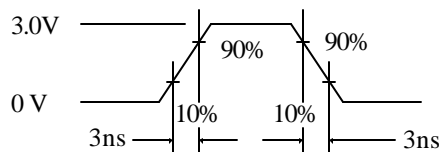

Fig.5

**AC CHARACTERISTICS**
 $(V_{CC} = 5V \pm 5\%, V_{SS} = 0V, T_a = 0 \text{ to } 70^\circ\text{C})$ 
**(1) READ CYCLE**

PARAMETER	SYM.	-7		-8		-10		-12		-15		UNIT
		MIN.	MAX.	MIN.	MAX.	MIN.	MAX.	MIN.	MAX.	MIN.	MAX.	
Read Cycle Time	t <sub>RC</sub>	7	-	8	-	10	-	12	-	15	-	ns
Address Access Time	t <sub>AA</sub>	-	7	-	8	-	10	-	12	-	15	ns
Chip Select Access Time	t <sub>ACS</sub>	-	7	-	8	-	10	-	12	-	15	ns
Output Enable to Output Valid	t <sub>AOE</sub>	-	3.5	-	5	-	6	-	7	-	7	ns
Chip Selection to Output in Low Z	t <sub>CLZ*</sub>	2	-	3	-	3	-	3	-	3	-	ns
Output Enable to Output in Low Z	t <sub>OLZ</sub>	0	-	0	-	0	-	0	-	0	-	ns
Chip Deselection to Output in High Z	t <sub>CHZ*</sub>	-	3.5	-	4	-	5	-	6	0	7	ns
Output Disable to Output in High Z	t <sub>OHZ</sub>	-	3.5	-	4	-	5	-	6	0	7	ns
Output Hold from Address Change	t <sub>OH</sub>	2	-	2.5	-	3	-	3	-	3	-	ns

\* These parameters are sampled but not 100% tested.

**(2) WRITE CYCLE**

PARAMETER	SYM.	-7		-8		-10		-12		-15		UNIT
		MIN.	MAX.	MIN.	MAX.	MIN.	MAX.	MIN.	MAX.	MIN.	MAX.	
Write Cycle Time	t <sub>WC</sub>	7	-	8	-	10	-	12	-	15	-	ns
Chip Selection to End of Write	t <sub>CW</sub>	5	-	6	-	8	-	10	-	11	-	ns
Address Valid to End of Write	t <sub>AW</sub>	5	-	6	-	8	-	10	-	11	-	ns
Address Setup Time	t <sub>AS</sub>	0	-	0	-	0	-	0	-	0	-	ns
Write Pulse Width	t <sub>WP</sub>	5	-	6	-	8	-	10	-	11	-	ns
Write Recovery Time	t <sub>WR</sub>	0	-	0	-	0	-	0	-	0	-	ns
Data Valid to End of Write	t <sub>DW</sub>	3.5	-	5	-	6	-	8	-	8	-	ns
Data Hold from End of Write	t <sub>DH</sub>	0	-	0	-	0	-	0	-	0	-	ns
Write to Output in High Z	t <sub>WHZ</sub>	-	3	-	4	-	5	-	6	-	6	ns
Output Disable to Output in High Z	t <sub>OHZ</sub>	-	3.5	-	4	-	5	-	6	-	7	ns
Output Active from End of Write	t <sub>OW</sub>	0	-	0	-	0	-	0	-	0	-	ns

\* These parameters are sampled but not 100% tested.

**TIMING WAVEFORMS**

**READ CYCLE 1**

(Address Controlled)

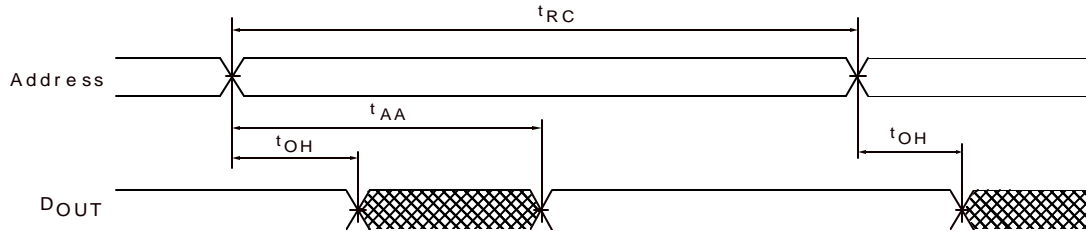

**READ CYCLE 2**

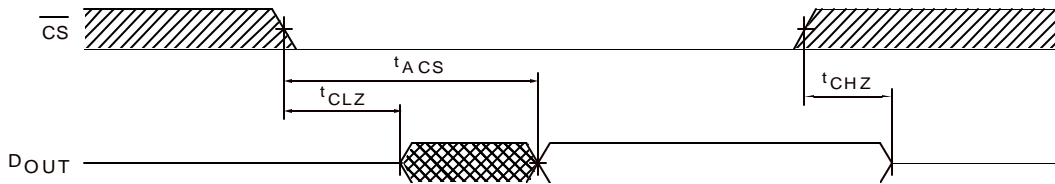

(Chip Select Controlled)

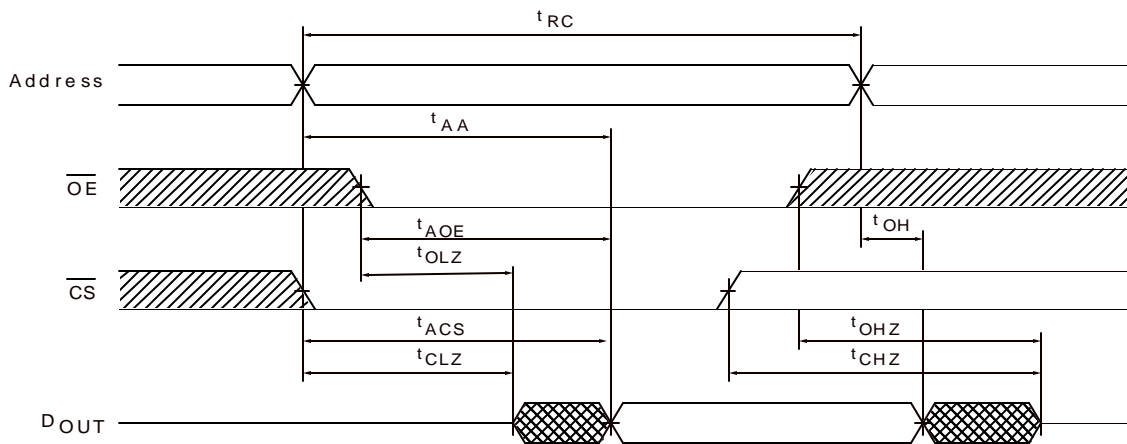

**READ CYCLE 3**

(Output Enable Controlled)



 DON'T CARE  
 UNDEF INED

WRITE CYCLE 1 ( $\overline{OE}$  CLOCK)

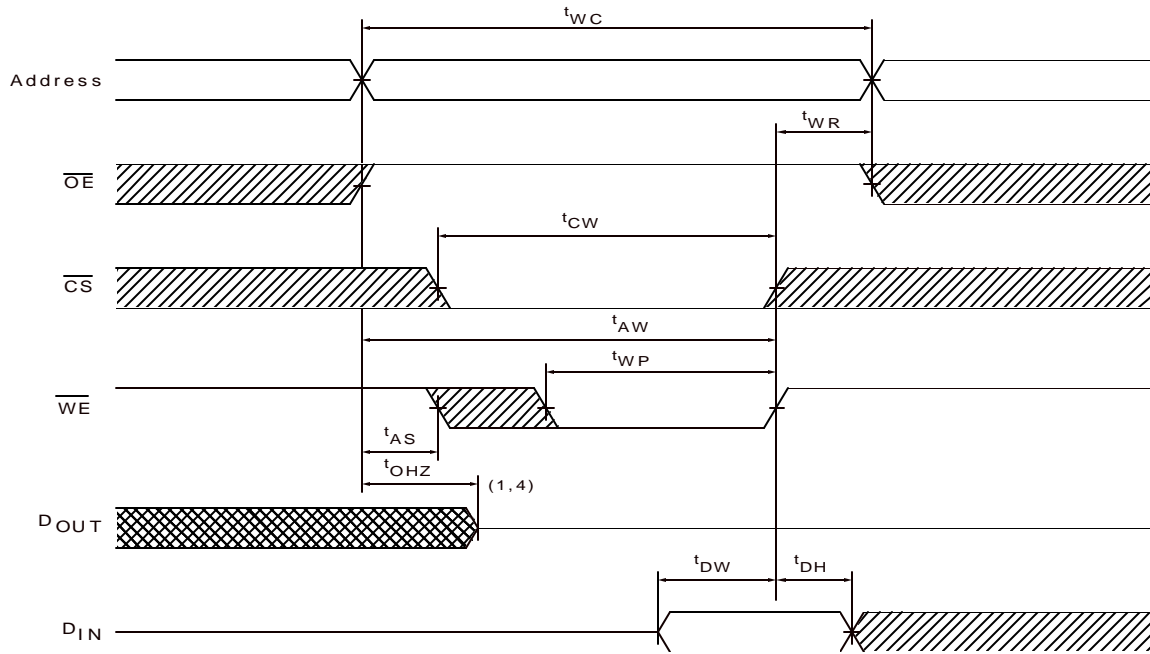

WRITE CYCLE 2 ( $\overline{OE} = V_{IL}$  Fixed)

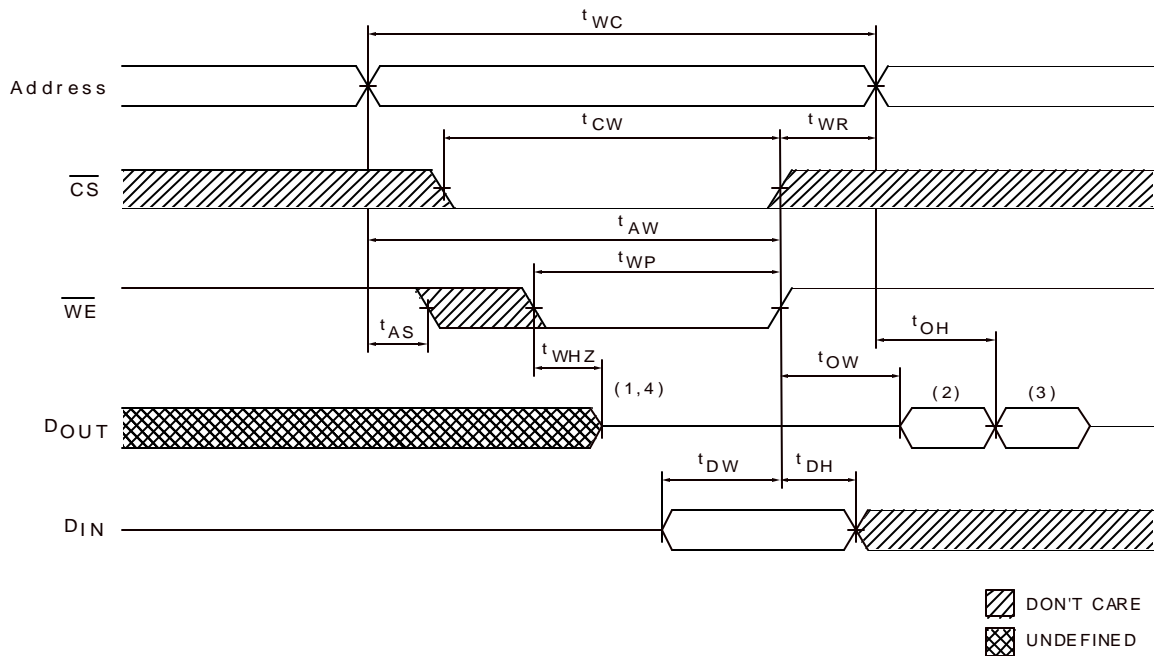

- Notes:
1. During this period, I/O pins are in the output state, so input signals of opposite phase to the outputs should not be applied.
  2. The data output from  $D_{OUT}$  are the same as the data written to  $D_{IN}$  during the write cycle.
  3.  $D_{OUT}$  provides the read data for the next address.
  4. Transition is measured  $\pm 500$  mV from steady state with  $C_L = 5$ pF. This parameter is guaranteed but not 100% tested.
  5. If  $\overline{OE}$  is low during a  $\overline{WE}$  controlled write cycle, the write pulse width must be the larger of  $t_{WP}$  or  $(t_{WHZ} + t_{DW})$  to allow the I/O drivers to turn off and data to be placed on the bus for the required  $t_{DW}$ . If  $\overline{OE}$  is high during a  $\overline{WE}$  controlled write cycle, this requirement does not apply and the write pulse can be as short as the specified  $t_{WP}$ .

**PACKAGE DIMENSIONS**  
**28-LEAD SOJ SRAM (300 mil)**

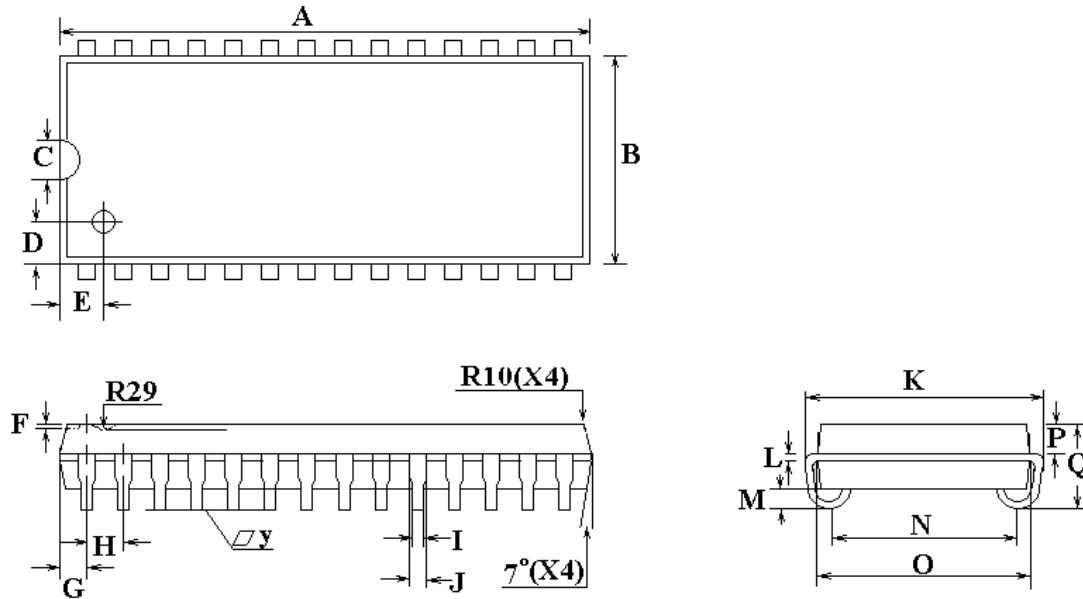

SYMBOL	DIMENSIONS IN INCHES	DIMENSIONS IN MM
A	0.710±0.002	18.03±0.05
B	0.300±0.005	7.62±0.13
C	0.060±0.002	1.52±0.05
D	0.050±0.001	1.27±0.03
E	0.063±0.001	1.63±0.03
F	0.015±0.002	0.38±0.05
G	0.030±0.002	0.76±0.05
H	0.050±0.002	1.27±0.05
I	0.018±0.002	0.46±0.05
J	0.028±0.002	0.71±0.05
K	0.337±0.002	8.56±0.05
L	0.010±0.001	0.25±0.03
M	0.026±0.002	0.66±0.05
N	0.268±0.003	6.81±0.08
O	0.300±0.002	7.62±0.05
P	0.053±0.001	1.35±0.03
Q	0.140±0.004	3.56±0.10
y	0.004(MAX)	0.10(MAX)



**PACKAGE DIMENSIONS**

**28-LEAD TSOP-I SRAM (8X13.4mm)**

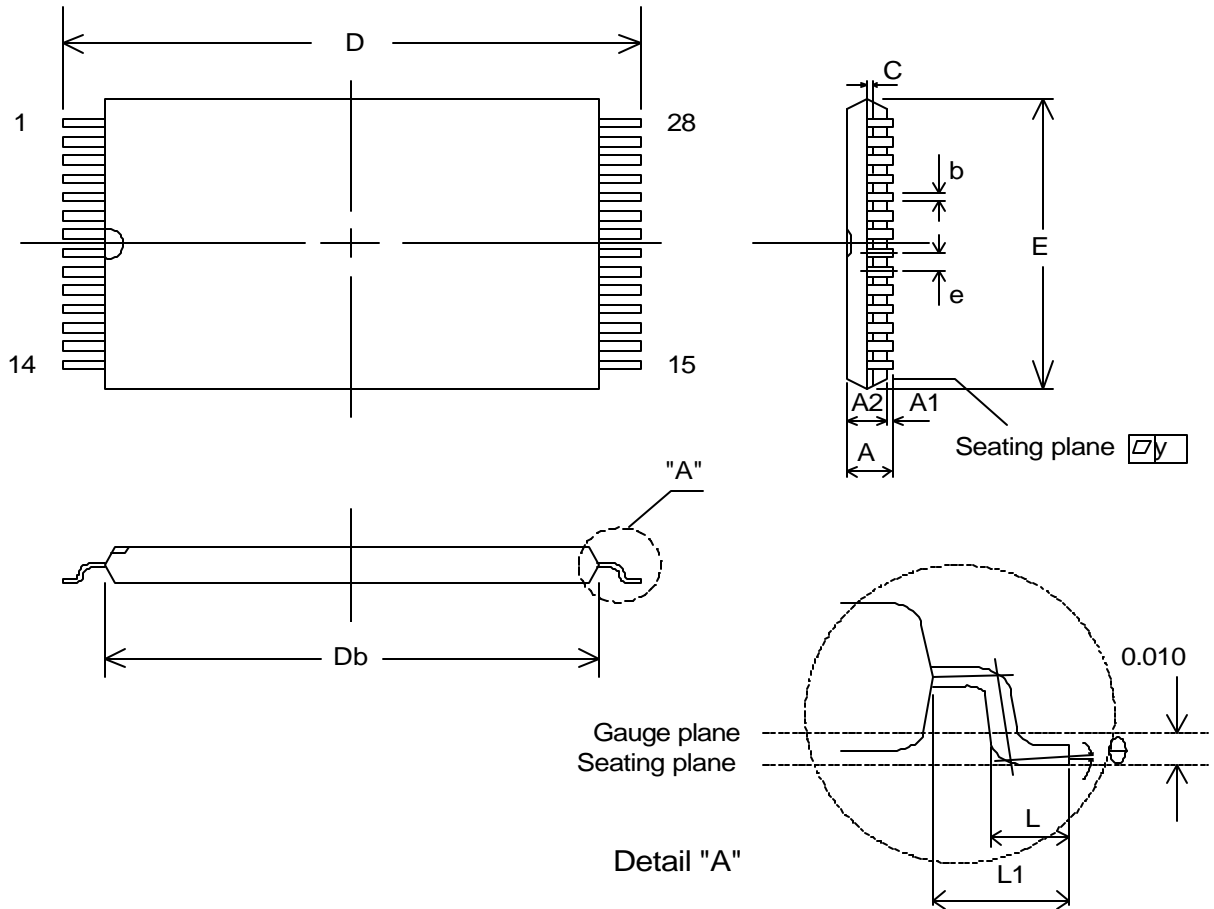

SYMBOL	DIMENSIONS IN INCHES	DIMENSIONS IN MM
A	0.047(max.)	1.20(max.)
A1	$0.004 \pm 0.002$	$0.10 \pm 0.05$
A2	$0.039 \pm 0.002$	$1.00 \pm 0.05$
b	0.008(typ.)	0.20(typ.)
c	0.006(typ.)	0.15(typ.)
Db	$0.465 \pm 0.004$	$11.80 \pm 0.10$
E	$0.315 \pm 0.004$	$8.00 \pm 0.10$
e	0.022(typ.)	0.55(typ.)
D	$0.528 \pm 0.008$	$13.40 \pm 0.20$
L	$0.020 \pm 0.004$	$0.50 \pm 0.10$
L1	$0.0315 \pm 0.004$	$0.80 \pm 0.10$
y	0.004(max.)	0.10(max.)
$\theta$	$0^\circ \sim 5^\circ$	$0^\circ \sim 5^\circ$