

V_{RM} = 600 V, I_{F(AV)} = 30 A, t_{rr} = 100 ns
Fast Recovery Diode
CTNS-6306S

Description

The CTNS-6306S is a fast recovery diode of 600 V, 30 A. The maximum t_{rr} of 100 ns is realized by optimizing a life-time control. The low thermal resistance package achieves high performance in terms of heat dissipation.

Features

- Bare Lead Frame: Pb-free (RoHS Compliant)
- V_{RM}-----600 V
- I_{F(AV)}-----30 A
- V_F-----1.3 V
- t_{rr}-----100 ns
- Flammability: Equivalent to UL94V-0

Applications

- PFC Circuit
- Inverter Circuit

Package

TO247-3L

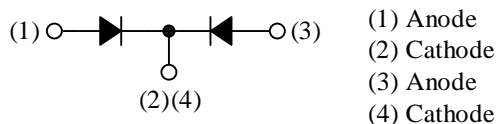
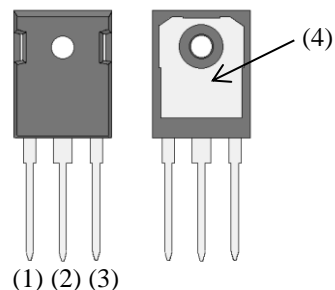

Not to scale

Absolute Maximum Ratings

 Unless otherwise specified, $T_A = 25\text{ }^\circ\text{C}$

| Parameter | Symbol | Conditions | Rating | Unit |
|------------------------------------|-------------|--|------------|----------------------|
| Nonrepetitive Peak Reverse Voltage | V_{RSM} | | 600 | V |
| Repetitive Peak Reverse Voltage | V_{RM} | | 600 | V |
| Average Forward Current | $I_{F(AV)}$ | See Figure 1 and Figure 2 | 30 | A |
| Surge Forward Current | I_{FSM} | Half cycle sine wave, positive side, 10 ms, 1 shot | 140 | A |
| I^2t Limiting Value | I^2t | $1\text{ ms} \leq t \leq 10\text{ ms}$ | 98 | A^2s |
| Junction Temperature | T_J | | -40 to 150 | $^\circ\text{C}$ |
| Storage Temperature | T_{STG} | | -40 to 150 | $^\circ\text{C}$ |

Electrical Characteristics

 Unless otherwise specified, $T_A = 25\text{ }^\circ\text{C}$

| Parameter | Symbol | Conditions | Min. | Typ. | Max. | Unit |
|--|---------------|--|------|------|------|--------------------|
| Forward Voltage Drop | V_F | $T_J = 25\text{ }^\circ\text{C}$, $I_F = 15\text{ A}$ | — | — | 1.3 | V |
| | | $T_J = 100\text{ }^\circ\text{C}$, $I_F = 15\text{ A}$ | — | 1.0 | — | V |
| Reverse Leakage Current | I_R | $V_R = V_{RM}$ | — | — | 100 | μA |
| Reverse Leakage Current Under High Temperature | $H \cdot I_R$ | $V_R = V_{RM}$, $T_J = 150\text{ }^\circ\text{C}$ | — | — | 10 | mA |
| Reverse Recovery Time | t_{rr1} | $I_F = I_{RP} = 500\text{ mA}$, 90% recovery point, $T_J = 25\text{ }^\circ\text{C}$ | — | — | 100 | ns |
| | t_{rr2} | $I_F = 100\text{ mA}$, $I_{RP} = 200\text{ mA}$, 75% recovery point, $T_J = 25\text{ }^\circ\text{C}$ | — | — | 50 | ns |
| Thermal Resistance ⁽¹⁾ | $R_{th(J-C)}$ | | — | — | 1.5 | $^\circ\text{C/W}$ |

Mechanical Characteristics

| Parameter | Conditions | Min. | Typ. | Max. | Unit |
|--------------------------------|------------|-------|------|-------|------|
| Heatsink Mounting Screw Torque | | 0.686 | — | 0.882 | N·m |
| Package Weight | | — | 6.1 | — | g |

⁽¹⁾ $R_{th(J-C)}$ is thermal resistance between junction and case.

Derating Curves

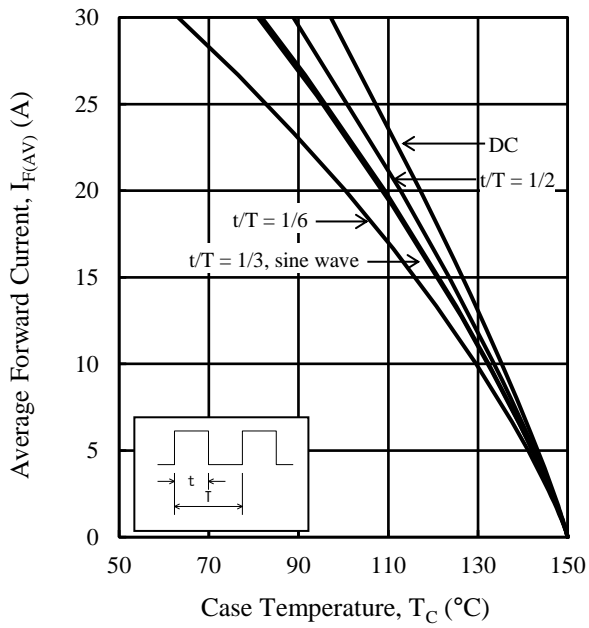

Figure 1. T_C vs. I_F ($T_J = 150$ °C, $V_R = 0$ V)

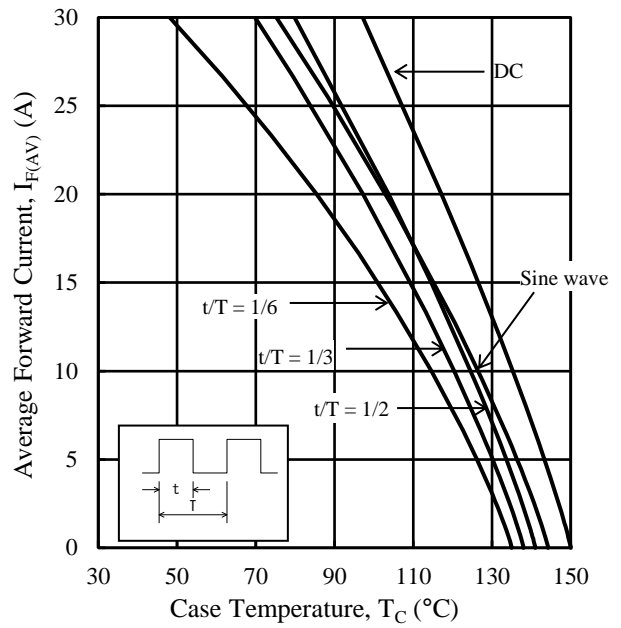

Figure 2. T_C vs. I_F ($T_J = 150$ °C, $V_R = 600$ V)

Characteristic Curves

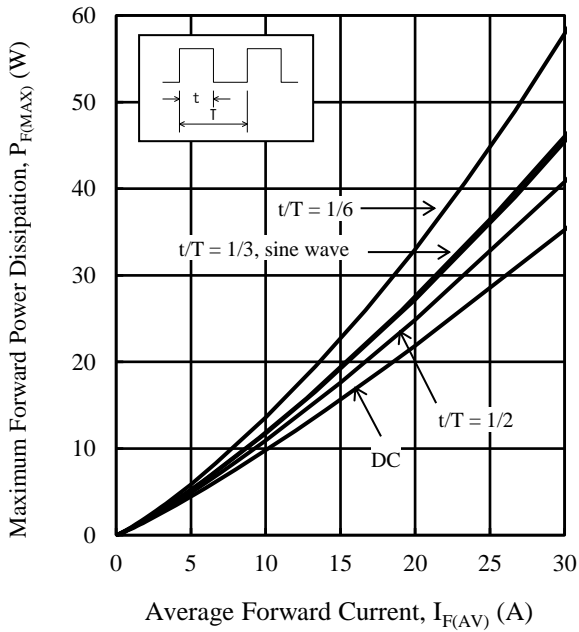

Figure 3. $P_{F(MAX)}$ vs. $I_{F(AV)}$ ($T_J = 150\text{ }^\circ\text{C}$)

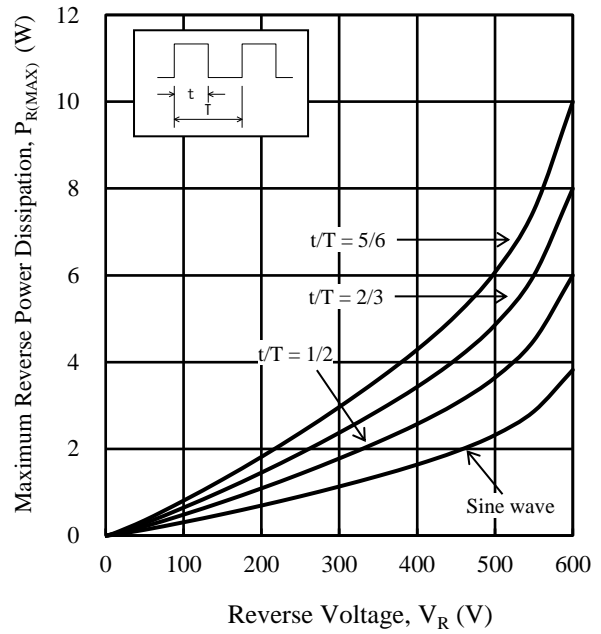

Figure 4. $P_{R(MAX)}$ vs. V_R ($T_J = 150\text{ }^\circ\text{C}$)

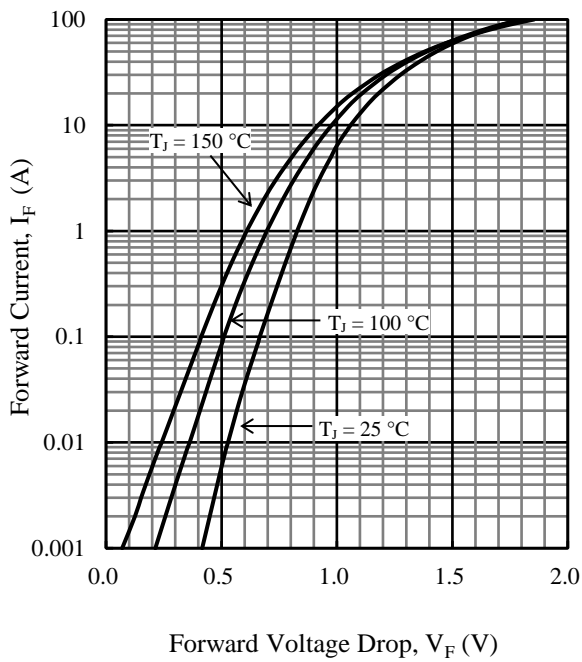

Figure 5. Typical Characteristics: V_F vs. I_F

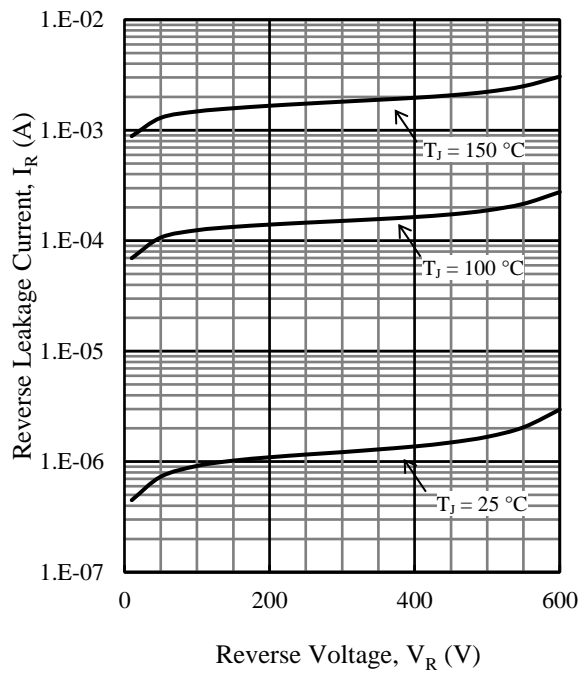

Figure 6. Typical Characteristics: V_R vs. I_R

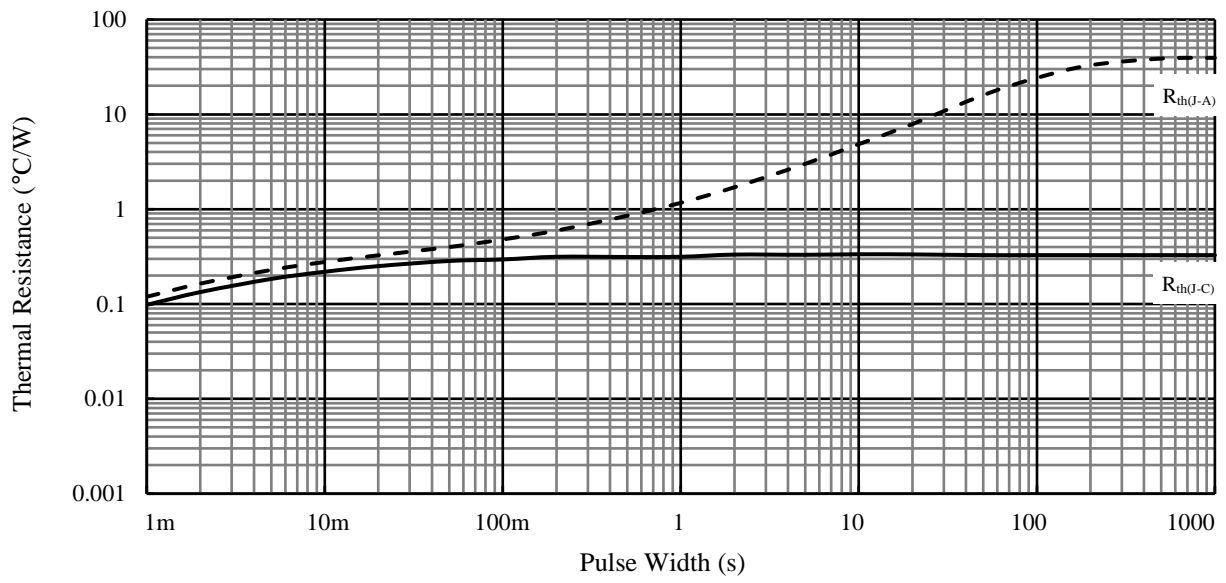
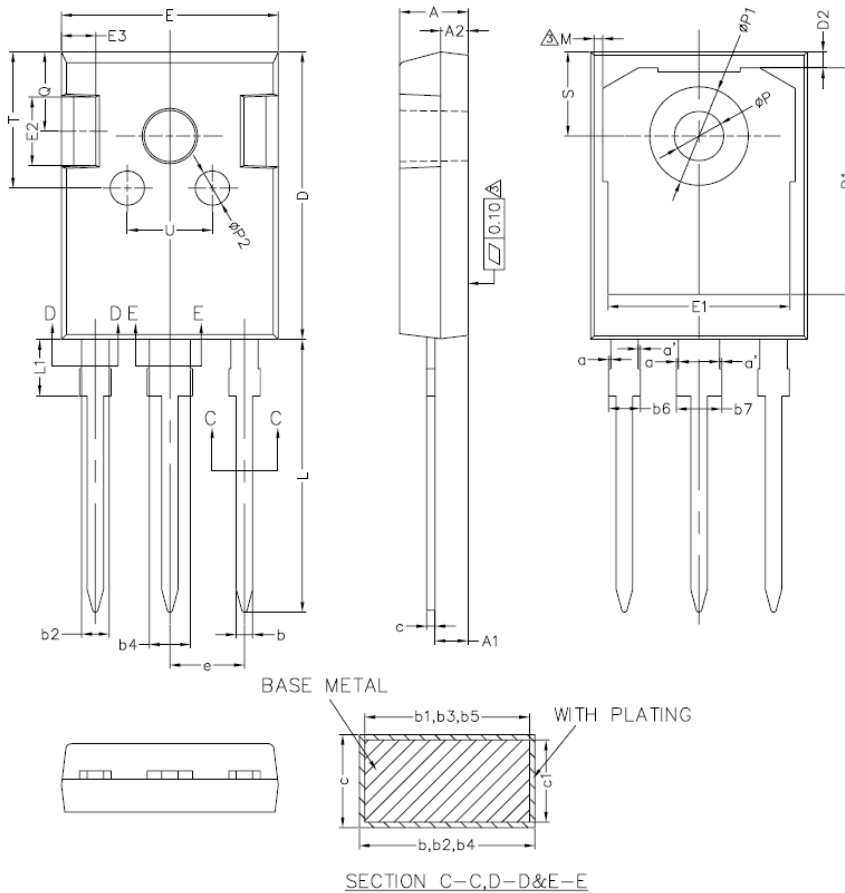

Figure 7. Typical Transient Thermal Resistance Characteristics

Physical Dimension

• TO247-3L



| Symbol | Min. | Typ. | Max. |
|--------|-------|-------|-------|
| A | 4.90 | 5.00 | 5.10 |
| A1 | 2.31 | 2.41 | 2.51 |
| A2 | 1.90 | 2.00 | 2.10 |
| a | 0 | — | 0.15 |
| a' | 0 | — | 0.15 |
| b | 1.16 | — | 1.26 |
| b1 | 1.15 | 1.2 | 1.22 |
| b2 | 1.96 | — | 2.06 |
| b3 | 1.95 | 2.00 | 2.02 |
| b4 | 2.96 | — | 3.06 |
| b5 | 2.95 | 3.00 | 3.02 |
| b6 | — | — | 2.25 |
| b7 | — | — | 3.25 |
| c | 0.59 | — | 0.66 |
| c1 | 0.58 | 0.60 | 0.62 |
| D | 20.90 | 21.00 | 21.10 |
| D1 | 16.25 | 16.55 | 16.85 |
| D2 | 1.05 | 1.20 | 1.35 |
| E | 15.70 | 15.80 | 15.90 |
| E1 | 13.10 | 13.30 | 13.50 |
| E2 | 4.90 | 5.00 | 5.10 |
| E3 | 2.40 | 2.50 | 2.60 |
| e | 5.34 | 5.44 | 5.54 |
| L | 19.80 | 19.92 | 20.10 |
| L1 | — | — | 4.30 |
| M | 0.35 | — | 0.95 |
| P | 3.50 | 3.60 | 3.70 |
| P1 | 7.00 | — | 7.40 |
| P2 | 2.40 | 2.50 | 2.60 |
| Q | 5.60 | — | 6.00 |
| S | 6.05 | 6.15 | 6.25 |
| T | 9.80 | — | 10.20 |
| U | 6.00 | — | 6.40 |

NOTES:

- Dimensions in millimeters
- All the dimensions exclude mold flashes.
- Bare lead frame: Pb-free (RoHS compliant)
- When soldering the products, it is required to minimize the working time within the following limits:
 Flow: 260 °C / 10 s, 1 time
 Soldering Iron: 350 °C / 3.5 s, 1 time
 Soldering should be at a distance of at least 1.5 mm from the body of the product.

Marking Diagram

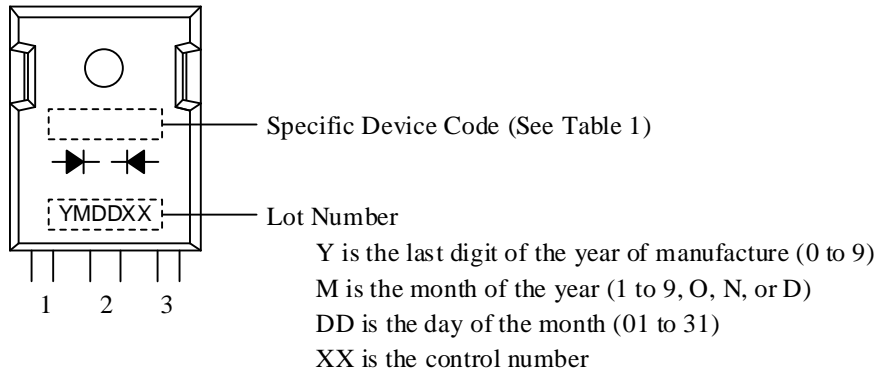

Table 1. Specific Device Code

| Specific Device Code | Part Number |
|----------------------|-------------|
| NS6306 | CTNS-6306S |

Important Notes

- All data, illustrations, graphs, tables and any other information included in this document (the “Information”) as to Sanken’s products listed herein (the “Sanken Products”) are current as of the date this document is issued. The Information is subject to any change without notice due to improvement of the Sanken Products, etc. Please make sure to confirm with a Sanken sales representative that the contents set forth in this document reflect the latest revisions before use.
- The Sanken Products are intended for use as components of general purpose electronic equipment or apparatus (such as home appliances, office equipment, telecommunication equipment, measuring equipment, etc.). Prior to use of the Sanken Products, please put your signature, or affix your name and seal, on the specification documents of the Sanken Products and return them to Sanken. When considering use of the Sanken Products for any applications that require higher reliability (such as transportation equipment and its control systems, traffic signal control systems or equipment, disaster/crime alarm systems, various safety devices, etc.), you must contact a Sanken sales representative to discuss the suitability of such use and put your signature, or affix your name and seal, on the specification documents of the Sanken Products and return them to Sanken, prior to the use of the Sanken Products. The Sanken Products are not intended for use in any applications that require extremely high reliability such as: aerospace equipment; nuclear power control systems; and medical equipment or systems, whose failure or malfunction may result in death or serious injury to people, i.e., medical devices in Class III or a higher class as defined by relevant laws of Japan (collectively, the “Specific Applications”). Sanken assumes no liability or responsibility whatsoever for any and all damages and losses that may be suffered by you, users or any third party, resulting from the use of the Sanken Products in the Specific Applications or in manner not in compliance with the instructions set forth herein.
- In the event of using the Sanken Products by either (i) combining other products or materials or both therewith or (ii) physically, chemically or otherwise processing or treating or both the same, you must duly consider all possible risks that may result from all such uses in advance and proceed therewith at your own responsibility.
- Although Sanken is making efforts to enhance the quality and reliability of its products, it is impossible to completely avoid the occurrence of any failure or defect or both in semiconductor products at a certain rate. You must take, at your own responsibility, preventative measures including using a sufficient safety design and confirming safety of any equipment or systems in/for which the Sanken Products are used, upon due consideration of a failure occurrence rate and derating, etc., in order not to cause any human injury or death, fire accident or social harm which may result from any failure or malfunction of the Sanken Products. Please refer to the relevant specification documents and Sanken’s official website in relation to derating.
- No anti-radioactive ray design has been adopted for the Sanken Products.
- The circuit constant, operation examples, circuit examples, pattern layout examples, design examples, recommended examples, all information and evaluation results based thereon, etc., described in this document are presented for the sole purpose of reference of use of the Sanken Products.
- Sanken assumes no responsibility whatsoever for any and all damages and losses that may be suffered by you, users or any third party, or any possible infringement of any and all property rights including intellectual property rights and any other rights of you, users or any third party, resulting from the Information.
- No information in this document can be transcribed or copied or both without Sanken’s prior written consent.
- Regarding the Information, no license, express, implied or otherwise, is granted hereby under any intellectual property rights and any other rights of Sanken.
- Unless otherwise agreed in writing between Sanken and you, Sanken makes no warranty of any kind, whether express or implied, including, without limitation, any warranty (i) as to the quality or performance of the Sanken Products (such as implied warranty of merchantability, and implied warranty of fitness for a particular purpose or special environment), (ii) that any Sanken Product is delivered free of claims of third parties by way of infringement or the like, (iii) that may arise from course of performance, course of dealing or usage of trade, and (iv) as to the Information (including its accuracy, usefulness, and reliability).
- In the event of using the Sanken Products, you must use the same after carefully examining all applicable environmental laws and regulations that regulate the inclusion or use or both of any particular controlled substances, including, but not limited to, the EU RoHS Directive, so as to be in strict compliance with such applicable laws and regulations.
- You must not use the Sanken Products or the Information for the purpose of any military applications or use, including but not limited to the development of weapons of mass destruction. In the event of exporting the Sanken Products or the Information, or providing them for non-residents, you must comply with all applicable export control laws and regulations in each country including the U.S. Export Administration Regulations (EAR) and the Foreign Exchange and Foreign Trade Act of Japan, and follow the procedures required by such applicable laws and regulations.
- Sanken assumes no responsibility for any troubles, which may occur during the transportation of the Sanken Products including the falling thereof, out of Sanken’s distribution network.
- Although Sanken has prepared this document with its due care to pursue the accuracy thereof, Sanken does not warrant that it is error free and Sanken assumes no liability whatsoever for any and all damages and losses which may be suffered by you resulting from any possible errors or omissions in connection with the Information.
- Please refer to our official website in relation to general instructions and directions for using the Sanken Products, and refer to the relevant specification documents in relation to particular precautions when using the Sanken Products.
- All rights and title in and to any specific trademark or tradename belong to Sanken and such original right holder(s).

DSGN-CEZ-16003