

High Precision Surface Mount 4 Resistor Network Dual-In-Line Package with TCR Tracking $\leq 0.5 \text{ ppm}/^\circ\text{C}$, Tolerance Match of 0.01 % and Ratio Stability of 0.005 %



Any value and any ratio available within resistance range

INTRODUCTION

Bulk Metal[®] Foil (BMF) Technology outperforms all other resistor technologies available today for applications that require High Precision and High Stability.

This technology has been pioneered and developed by Vishay Foil Resistors (VFR), and products based on this technology are the most suitable for a wide range of applications.

BMF technology allows us to produce Customer Orientated products designed to satisfy challenging and specific technical requirements.

Model SMN offers low TCR (absolute and tracking), excellent load life stability, tight tolerance (absolute and match), excellent ratio stability, low thermal EMF, low current noise and low voltage coefficient - **all in the same resistor**.

The SMN Surface Mount Network is made up of 4 independent BMF resistors in a small standard molded epoxy package with 50 MIL lead pitch (JEDEC MS-012 package).

The electrical specification of this integrated construction offers improved performance and better real estate utilization over discrete resistors and matched sets. The resistor may be used independently or as divider pairs.

Our Application Engineering Department is available to advise and make recommendations. For non-standard technical requirements and special applications, please contact us.

TABLE 1 - RESISTANCE VALUES AND TOLERANCES (Tighter performances are available)	
RESISTANCE VALUES	100 Ω - 10 k Ω per resistor
ABSOLUTE TOLERANCE EACH RESISTOR	$\pm 0.02 \%$, $\pm 0.05 \%$, $\pm 0.1 \%$
RESISTANCE TOLERANCE MATCH	0.01 %, 0.02 %, 0.05 %

* Pb containing terminations are not RoHS compliant, exemptions may apply

FEATURES

- Temperature Coefficient of Resistance (TCR) (- 55 $^\circ\text{C}$ to + 125 $^\circ\text{C}$, + 25 $^\circ\text{C}$ Ref):
Absolute: $\pm 2 \text{ ppm}/^\circ\text{C}$ typical (see table 2)
Tracking: 0.5 $\text{ppm}/^\circ\text{C}$ typical (see table 2)
- Power Rating: at 70 $^\circ\text{C}$
Entire Package: 0.4 W
Each Resistor: 0.1 W
- Resistance Tolerance Match: 0.01 %
- Ratio Stability: 0.005 % (0.1 W at 70 $^\circ\text{C}$, 2000 hours)
- Large Variety of Resistance Ratios
- Electrostatic Discharge (ESD) above 25 000 Volts
- Short Time Overload $\leq 0.0025 \%$
- Non Inductive, Non Capacitive Design
- Rise Time: 1 ns without ringing
- Current Noise: < - 40 dB
- Thermal EMF: 0.05 $\mu\text{V}/^\circ\text{C}$
- Voltage Coefficient < 0.1 ppm/V
- Non Inductive: < 0.08 μH
- Non Hot Spot Design
- Terminal Finishes available: Lead (Pb)-free Tin/Lead Alloy
- For better performances please contact us
- Available with Z-Foil technology, please see SMNZ datasheet



RoHS*
COMPLIANT

APPLICATIONS

- Instrumentation Amplifiers
- Bridge Networks
- Differential Amplifiers
- Ratio Arms in Bridge Circuits
- Medical and Test Equipment
- Military
- Airborne etc.

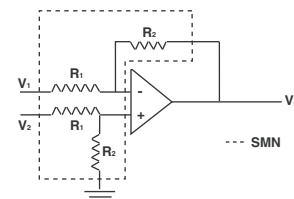

FIGURE 1 - SCHEMATICS¹⁾

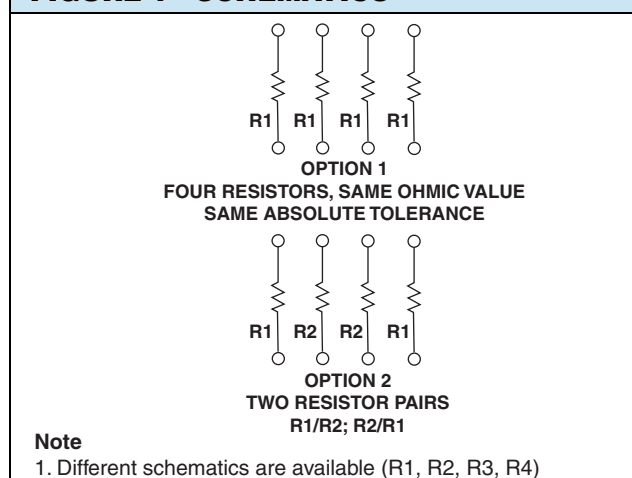

FIGURE 2 - POWER DERATING CURVE

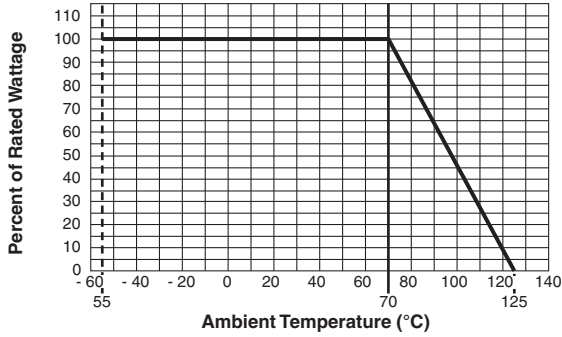

FIGURE 4 - TYPICAL TCR CURVE

(For more details, see table 2)

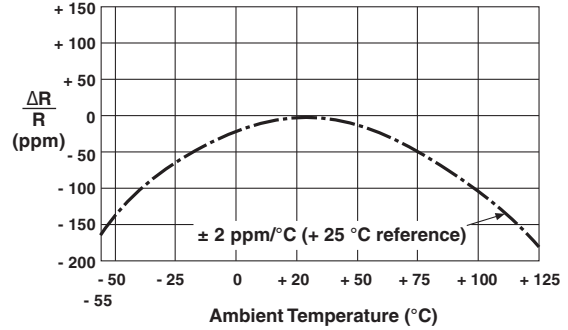
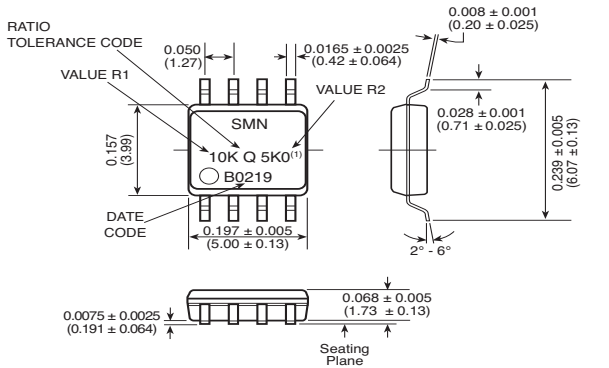
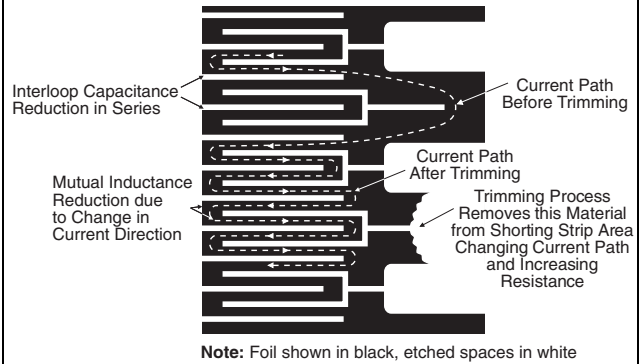

FIGURE 3 - DIMENSIONS AND IMPRINTING EXAMPLE in inches (millimeters)



Note
⁽¹⁾ If the resistance value of R1 and R2 contains more than 6 characters together, the VCODE will be printed instead (see Resistance Value Code List for Popular Ratios Table) followed by the ratio tolerance code

FIGURE 5 - TRIMMING TO VALUES (Conceptual Illustration)



Note: Foil shown in black, etched spaces in white

FIGURE 6 - LAND PATTERN in inches (millimeters)

	Z	G	X	Y	C	D	E
MINIMUM	0.283 (7.19)	0.102 (2.59)	0.024 (0.61)	0.095 (2.41)	0.197 (5.00)	0.150 (3.81)	0.050 (1.27)
MAXIMUM	0.291 (7.39)	0.110 (2.79)	0.032 (0.81)	REFERENCE			

TABLE 2 - PERFORMANCE SPECIFICATIONS (Per MIL-PRF 914 Test Methods)	
SPECIFICATIONS	TYPICAL LIMITS
Power Rating at + 70 °C	Each resistor: 0.1 W Entire package: 0.4 W
Maximum Working Voltage (each resistor)	$(P \times R)^{1/2}$
TCR - 55 °C to + 125 °C (25 °C reference)	Absolute (typical and max. spread): $\pm 2 \pm 3$ ppm/°C Tracking (maximum): For R1/R2 = 1 1.0 ppm/°C For 1 < R1/R2 ≤ 10 2.0 ppm/°C For 10 < R1/R2 ≤ 100 3.0 ppm/°C
Thermal Shock 25 x (- 65 °C to + 125 °C)	$\Delta R = 0.01 \%$ (100 ppm) $\Delta \text{Ratio} = 0.01 \%$ (100 ppm)
Thermal Shock 5 x (- 65 °C to + 125 °C) and Power Conditioning 1.5 rated power at 25 °C, 100 hours	$\Delta R = 0.02 \%$ (200 ppm) $\Delta \text{Ratio} = 0.015 \%$ (150 ppm)
DWV Atm. Pressure 200 V (A.C), 1 minute	Successfully passed
Insulation Resistance 100 V (D.C), 1 minute	> 10 ⁴ MΩ
Resistance to Soldering Heat	$\Delta R = 0.01 \%$ (100 ppm) $\Delta \text{Ratio} = 0.005 \%$ (50 ppm)
Moisture Resistance + 65 °C to - 10 °C; 90 % to 98 % RH; 0.1 x rated power; 240 hours	$\Delta R = 0.02 \%$ (200 ppm) $\Delta \text{Ratio} = 0.005 \%$ (50 ppm)
Shock (Specified Pulse) 100G	$\Delta R = 0.01 \%$ (100 ppm) $\Delta \text{Ratio} = 0.01 \%$ (100 ppm)
Vibration, High Frequency (10 Hz - 2000 Hz), 20G	$\Delta R = 0.005 \%$ (50 ppm) $\Delta \text{Ratio} = 0.005 \%$ (50 ppm)
High Temperature Exposure 100 hours at 125 °C	$\Delta R = 0.01 \%$ (100 ppm) $\Delta \text{Ratio} = 0.005 \%$ (50 ppm)
Low Temperature Storage 24 hours at - 65 °C	$\Delta R = 0.005 \%$ (50 ppm) $\Delta \text{Ratio} = 0.005 \%$ (50 ppm)
Load Life Stability at 70 °C; 0.1 watt per resistor, 2000 hours	$\Delta R = 0.005 \%$ (50 ppm) $\Delta \text{Ratio} = 0.005 \%$ (50 ppm)
Short Time Overload 6.25 x Rated Power; 5 seconds	$\Delta R = 0.005 \%$ (50 ppm) $\Delta \text{Ratio} = 0.0025 \%$ (25 ppm)
Weight	0.08 g

TABLE 3 - GLOBAL PART NUMBER INFORMATION

NEW GLOBAL PART NUMBER: Y1365V0204QT9W (preferred part number format)

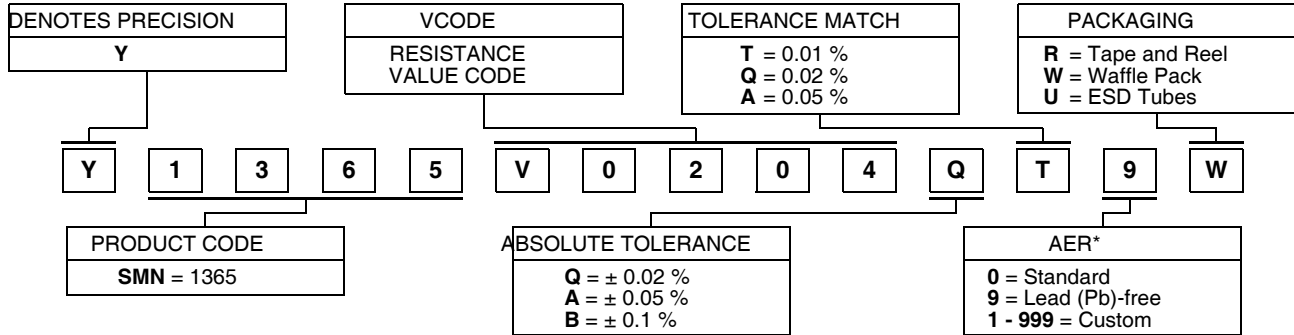

FOR EXAMPLE: ABOVE GLOBAL ORDER Y1365 V0204 Q T 9 W:

TYPE: SMN
VALUES: 10K/500R
ABSOLUTE TOLERANCE: ± 0.02 %
TOLERANCE MATCH: 0.01 %
TERMINATION: Lead (Pb)-free
PACKAGING: Waffle Pack

HISTORICAL PART NUMBER: SMN 10K/500R TCR2 Q T S W (will continue to be used)

SMN	10K/500R	TCR2	Q	T	S	W
MODEL	RESISTANCE VALUE	ABSOLUTE TCR	ABSOLUTE TOLERANCE	TOLERANCE MATCH	TERMINATION	PACKAGING
SMN	R ₁ = 10 kΩ R ₂ = 500 Ω	TCR2	Q = ± 0.02 % A = ± 0.05 % B = ± 0.1 %	T = 0.01 % Q = 0.02 % A = 0.05 %	S = Lead (Pb)-free B = Tin/Lead	T = Tape and Reel W = Waffle Pack U = ESD Tubes

Note

* For non-standard requests, please contact Application Engineering.

TABLE 4 - RESISTANCE VALUE CODE LIST FOR POPULAR RATIOS

VCODES	R1/R2 RATIO	R1	R2	VCODES	R1/R2 RATIO	R1	R2
V0201	100	10K	100R	V0189	2.5	1K	400R
V0202	50	10K	200R	V0185		500R	200R
V0197		5K	100R	V0207	2	10K	5K
V0203	25	10K	400R	V0175		2K	1K
V0198		5K	200R	V0190		1K	500R
V0204	20	10K	500R	V0182		400R	200R
V0193		2K	100R	V0179	200R	100R	
V0205	10	10K	1K	V0186	1.25	500R	400R
V0194		2K	200R	V0178	1	100R	100R
V0187		1K	100R	V0180		200R	200R
V0200	5K	1K	V0183	400R		400R	
V0195	5	2K	400R	V0023		500R	500R
V0188		1K	200R	V0191	1K	1K	
V0184		500R	100R	V0176	2K	2K	
V0196	4	2K	500R	V0019	5K	5K	
V0181		400R	100R	V0008	10K	10K	

Note

• Other values available upon request.



Disclaimer

ALL PRODUCTS, PRODUCT SPECIFICATIONS AND DATA ARE SUBJECT TO CHANGE WITHOUT NOTICE.

Vishay Precision Group, Inc., its affiliates, agents, and employees, and all persons acting on its or their behalf (collectively, "VPG"), disclaim any and all liability for any errors, inaccuracies or incompleteness contained herein or in any other disclosure relating to any product.

The product specifications do not expand or otherwise modify VPG's terms and conditions of purchase, including but not limited to, the warranty expressed therein.

VPG makes no warranty, representation or guarantee other than as set forth in the terms and conditions of purchase. **To the maximum extent permitted by applicable law, VPG disclaims (i) any and all liability arising out of the application or use of any product, (ii) any and all liability, including without limitation special, consequential or incidental damages, and (iii) any and all implied warranties, including warranties of fitness for particular purpose, non-infringement and merchantability.**

Information provided in datasheets and/or specifications may vary from actual results in different applications and performance may vary over time. Statements regarding the suitability of products for certain types of applications are based on VPG's knowledge of typical requirements that are often placed on VPG products. It is the customer's responsibility to validate that a particular product with the properties described in the product specification is suitable for use in a particular application. You should ensure you have the current version of the relevant information by contacting VPG prior to performing installation or use of the product, such as on our website at vpgsensors.com.

No license, express, implied, or otherwise, to any intellectual property rights is granted by this document, or by any conduct of VPG.

The products shown herein are not designed for use in life-saving or life-sustaining applications unless otherwise expressly indicated. Customers using or selling VPG products not expressly indicated for use in such applications do so entirely at their own risk and agree to fully indemnify VPG for any damages arising or resulting from such use or sale. Please contact authorized VPG personnel to obtain written terms and conditions regarding products designed for such applications.

Product names and markings noted herein may be trademarks of their respective owners.

Copyright Vishay Precision Group, Inc., 2014. All rights reserved.