

TLC225x, TLC225xA
Advanced LinCMOS™ RAIL-TO-RAIL
VERY LOW-POWER OPERATIONAL AMPLIFIERS

SLOS176D – FEBRUARY 1997 – REVISED MARCH 2001

- **Output Swing Includes Both Supply Rails**
- **Low Noise . . . 19 nV/√Hz Typ at f = 1 kHz**
- **Low Input Bias Current . . . 1 pA Typ**
- **Fully Specified for Both Single-Supply and Split-Supply Operation**
- **Very Low Power . . . 35 μA Per Channel Typ**
- **Common-Mode Input Voltage Range Includes Negative Rail**
- **Low Input Offset Voltage**
850 μV Max at T_A = 25°C (TLC225xA)
- **Macromodel Included**
- **Performance Upgrades for the TS27L2/L4 and TLC27L2/L4**
- **Available in Q-Temp Automotive HighRel Automotive Applications Configuration Control / Print Support Qualification to Automotive Standards**

description

The TLC2252 and TLC2254 are dual and quadruple operational amplifiers from Texas Instruments. Both devices exhibit rail-to-rail output performance for increased dynamic range in single- or split-supply applications. The TLC225x family consumes only 35 μA of supply current per channel. This micropower operation makes them good choices for battery-powered applications. The noise performance has been dramatically improved over previous generations of CMOS amplifiers. Looking at Figure 1, the TLC225x has a noise level of 19 nV/√Hz at 1kHz; four times lower than competitive micropower solutions.

The TLC225x amplifiers, exhibiting high input impedance and low noise, are excellent for small-signal conditioning for high-impedance sources, such as piezoelectric transducers. Because of the micropower dissipation levels, these devices work well in hand-held monitoring and remote-sensing applications. In addition, the rail-to-rail output feature with single or split supplies makes this family a great choice when interfacing with analog-to-digital converters (ADCs). For precision applications, the TLC225xA family is available and has a maximum input offset voltage of 850 μV. This family is fully characterized at 5 V and ±5 V.

The TLC2252/4 also makes great upgrades to the TLC27L2/L4 or TS27L2/L4 in standard designs. They offer increased output dynamic range, lower noise voltage, and lower input offset voltage. This enhanced feature set allows them to be used in a wider range of applications. For applications that require higher output drive and wider input voltage ranges, see the TLV2432 and TLV2442 devices. If the design requires single amplifiers, please see the TLV2211/21/31 family. These devices are single rail-to-rail operational amplifiers in the SOT-23 package. Their small size and low power consumption, make them ideal for high density, battery-powered equipment.

**EQUIVALENT INPUT NOISE VOLTAGE
VS
FREQUENCY**

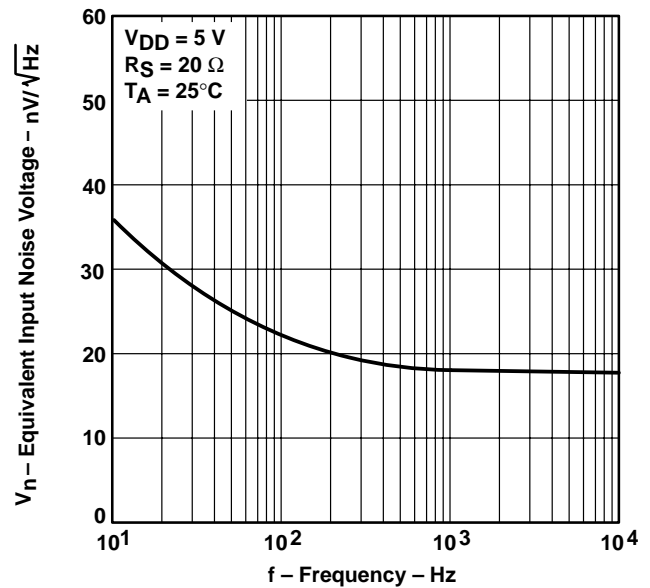

Figure 1



Please be aware that an important notice concerning availability, standard warranty, and use in critical applications of Texas Instruments semiconductor products and disclaimers thereto appears at the end of this data sheet.

Advanced LinCMOS is a trademark of Texas Instruments.

PRODUCTION DATA information is current as of publication date. Products conform to specifications per the terms of Texas Instruments standard warranty. Production processing does not necessarily include testing of all parameters.



POST OFFICE BOX 655303 • DALLAS, TEXAS 75265

Copyright © 2001, Texas Instruments Incorporated
 On products compliant to MIL-PRF-38535, all parameters are tested unless otherwise noted. On all other products, production processing does not necessarily include testing of all parameters.

TLC225x, TLC225xA
Advanced LinCMOS™ RAIL-TO-RAIL
VERY LOW-POWER OPERATIONAL AMPLIFIERS

SLOS176D – FEBRUARY 1997 – REVISED MARCH 2001

TLC2252 AVAILABLE OPTIONS

T _A	V _{IO} max AT 25°C	PACKAGED DEVICES					
		SMALL OUTLINE† (D)	CHIP CARRIER (FK)	CERAMIC DIP (JG)	PLASTIC DIP (P)	TSSOP‡ (PW)	CERAMIC FLATPACK (U)
0°C to 70°C	1500 µV	TLC2252CD	—	—	TLC2252CP	TLC2252CPW	—
–40°C to 125°C	850 µV 1500 µV	TLC2252AID TLC2252ID	— —	— —	TLC2252AIP TLC2252IP	TLC2252AIPW —	— —
–40°C to 125°C	850 µV 1500 µV	TLC2252AQD TLC2252QD	— —	— —	— —	— —	— —
–55°C to 125°C	850 µV 1500 µV	— —	TLC2252AMFK TLC2252MFK	TLC2252AMJG TLC2252MJG	— —	— —	TLC2252AMU TLC2252MU

† The D packages are available taped and reeled. Add R suffix to device type (e.g., TLC2262CDR).

‡ The PW package is available only left-ended taped and reeled.

§ Chip forms are tested at 25°C only.

TLC2254 AVAILABLE OPTIONS

T _A	V _{IO} max AT 25°C	PACKAGED DEVICES					
		SMALL OUTLINE† (D)	CHIP CARRIER (FK)	CERAMIC DIP (J)	PLASTIC DIP (N)	TSSOP‡ (PW)	CERAMIC FLATPACK (W)
0°C to 70°C	1500 µV	TLC2254CD	—	—	TLC2254CN	TLC2254CPW	—
–40°C to 125°C	850 µV 1500 µV	TLC2254AID TLC2254ID	— —	— —	TLC2254AIN TLC2254IN	TLC2254AIPW —	— —
–40°C to 125°C	850 µV 1500 µV	TLC2254AQD TLC2254QD	— —	— —	— —	— —	— —
–55°C to 125°C	850 µV 1500 µV	— —	TLC2254AMFK TLC2254MFK	TLC2254AMJ TLC2254MJ	— —	— —	TLC2254AMW TLC2254MW

† The D packages are available taped and reeled. Add R suffix to the device type (e.g., TLC2254CDR).

‡ The PW package is available only left-end taped and reeled. Chips are tested at 25°C.

§ Chip forms are tested at 25°C only.



TLC225x, TLC225xA
Advanced LinCMOS™ RAIL-TO-RAIL
VERY LOW-POWER OPERATIONAL AMPLIFIERS

SLOS176D – FEBRUARY 1997 – REVISED MARCH 2001

TLC2252C, TLC2252AC
TLC2252I, TLC2252AI
TLC2252Q, TLC2252AQ
D, P, OR PW PACKAGE
(TOP VIEW)

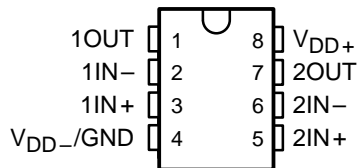

TLC2252M, TLC2252AM ... FK PACKAGE
(TOP VIEW)

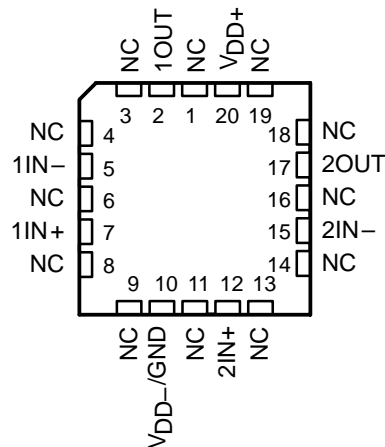

TLC2252M, TLC2252AM ... JG PACKAGE
(TOP VIEW)

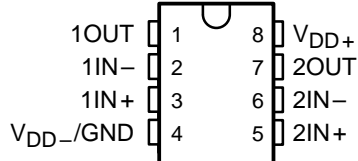

TLC2262M, TLC2252AM ... U PACKAGE
(TOP VIEW)

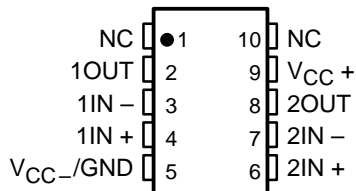

TLC2254C, TLC2254AC
TLC2254I, TLC2254AI
TLC2254Q, TLC2254AQ
D, N, OR PW PACKAGE
(TOP VIEW)

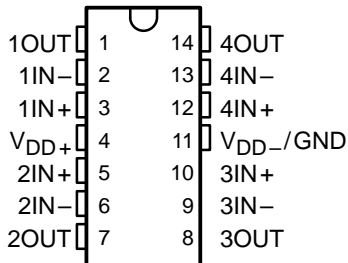

TLC2254M, TLC2254AM
J OR W PACKAGE
(TOP VIEW)

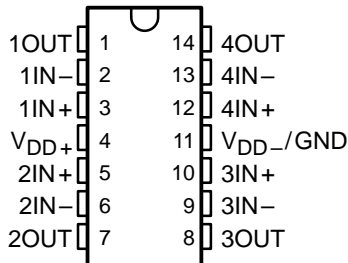

TLC2254M, TLC2254AM
FK PACKAGE
(TOP VIEW)

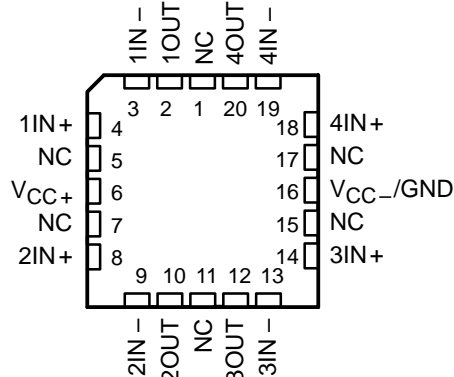

NC – No internal connection

TLC225x, TLC225xA
Advanced LinCMOS™ RAIL-TO-RAIL
VERY LOW-POWER OPERATIONAL AMPLIFIERS

SLOS176D – FEBRUARY 1997 – REVISED MARCH 2001

equivalent schematic (each amplifier)

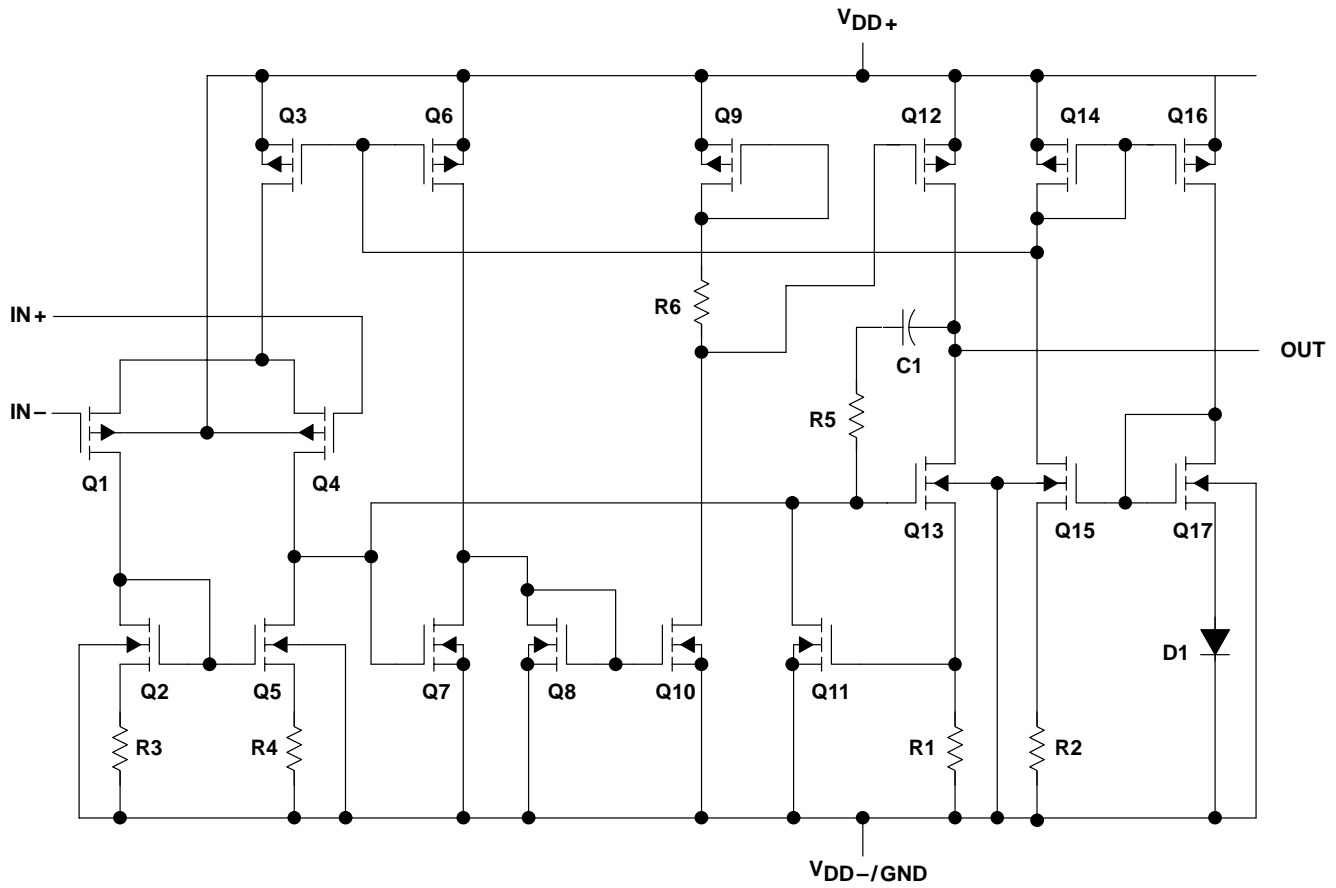

ACTUAL DEVICE COMPONENT COUNT†		
COMPONENT	TLC2252	TLC2254
Transistors	38	76
Resistors	30	56
Diodes	9	18
Capacitors	3	6

† Includes both amplifiers and all ESD, bias, and trim circuitry

TLC225x, TLC225xA
Advanced LinCMOS™ RAIL-TO-RAIL
VERY LOW-POWER OPERATIONAL AMPLIFIERS

SLOS176D – FEBRUARY 1997 – REVISED MARCH 2001

absolute maximum ratings over operating free-air temperature range (unless otherwise noted)†

Supply voltage, V_{DD+} (see Note 1)	8 V
Supply voltage, V_{DD-} (see Note 1)	–8 V
Differential input voltage, V_{ID} (see Note 2)	±16 V
Input voltage, V_I (any input, see Note 1)	±8 V
Input current, I_I (each input)	±5 mA
Output current, I_O	±50 mA
Total current into V_{DD+}	±50 mA
Total current out of V_{DD-}	±50 mA
Duration of short-circuit current at (or below) 25°C (see Note 3)	unlimited
Continuous total dissipation	See Dissipation Rating Table
Operating free-air temperature range, T_A : C suffix	0°C to 70°C
I suffix	–40°C to 125°C
Q suffix	–40°C to 125°C
M suffix	–55°C to 125°C
Storage temperature range, T_{stg}	–65°C to 150°C
Lead temperature 1,6 mm (1/16 inch) from case for 10 seconds	260°C

† Stresses beyond those listed under “absolute maximum ratings” may cause permanent damage to the device. These are stress ratings only, and functional operation of the device at these or any other conditions beyond those indicated under “recommended operating conditions” is not implied. Exposure to absolute-maximum-rated conditions for extended periods may affect device reliability.

- NOTES: 1. All voltage values, except differential voltages, are with respect to the midpoint between V_{DD+} and V_{DD-} .
2. Differential voltages are at $IN+$ with respect to $IN-$. Excessive current flows when input is brought below $V_{DD-} - 0.3$ V.
3. The output may be shorted to either supply. Temperature and/or supply voltages must be limited to ensure that the maximum dissipation rating is not exceeded.

DISSIPATION RATING TABLE

PACKAGE	$T_A \leq 25^\circ\text{C}$ POWER RATING	DERATING FACTOR ABOVE $T_A = 25^\circ\text{C}$	$T_A = 70^\circ\text{C}$ POWER RATING	$T_A = 85^\circ\text{C}$ POWER RATING	$T_A = 125^\circ\text{C}$ POWER RATING
D–8	724 mW	5.8 mW/°C	464 mW	377 mW	144 mW
D–14	950 mW	7.6 mW/°C	608 mW	450 mW	190 mW
FK	1375 mW	11.0 mW/°C	880 mW	715 mW	275 mW
J	1375 mW	11.0 mW/°C	880 mW	715 mW	275 mW
JG	1050 mW	8.4 mW/°C	672 mW	546 mW	275 mW
N	1150 mW	9.2 mW/°C	736 mW	736 mW	—
P	1000 mW	8.0 mW/°C	640 mW	520 mW	—
PW–8	525 mW	4.2 mW/°C	336 mW	273 mW	—
PW–14	700 mW	5.6 mW/°C	448 mW	448 mW	—
U	700 mW	5.5 mW/°C	246 mW	330 mW	150 mW
W	700 mW	5.5 mW/°C	246 mW	330 mW	150 mW

recommended operating conditions

	C SUFFIX		I SUFFIX		Q SUFFIX		M SUFFIX		UNIT
	MIN	MAX	MIN	MAX	MIN	MAX	MIN	MAX	
Supply voltage, $V_{DD\pm}$	±2.2	±8	±2.2	±8	±2.2	±8	±2.2	±8	V
Input voltage range, V_I	V_{DD-}	$V_{DD+} - 1.5$	V_{DD-}	$V_{DD+} - 1.5$	V_{DD-}	$V_{DD+} - 1.5$	V_{DD-}	$V_{DD+} - 1.5$	V
Common-mode input voltage, V_{IC}	V_{DD-}	$V_{DD+} - 1.5$	V_{DD-}	$V_{DD+} - 1.5$	V_{DD-}	$V_{DD+} - 1.5$	V_{DD-}	$V_{DD+} - 1.5$	V
Operating free-air temperature, T_A	0	70	–40	125	–40	125	–55	125	°C



TLC225x, TLC225xA
Advanced LinCMOS™ RAIL-TO-RAIL
VERY LOW-POWER OPERATIONAL AMPLIFIERS

SLOS176D – FEBRUARY 1997 – REVISED MARCH 2001

electrical characteristics at specified free-air temperature, $V_{DD} = 5\text{ V}$ (unless otherwise noted)

PARAMETER	TEST CONDITIONS	T_A †	TLC2252C			UNIT
			MIN	TYP	MAX	
V_{IO} Input offset voltage	$V_{IC} = 0,$ $V_O = 0,$ $V_{DD} \pm = \pm 2.5\text{ V},$ $R_S = 50\ \Omega$	25°C	200	1500	μV	
		Full range	1750			
α_{VIO} Temperature coefficient of input offset voltage		25°C to 70°C	0.5		$\mu\text{V}/^\circ\text{C}$	
Input offset voltage long-term drift (see Note 4)		25°C	0.003		$\mu\text{V}/\text{mo}$	
I_{IO} Input offset current		25°C	0.5	60	pA	
		Full range	100			
I_{IB} Input bias current		25°C	1	60	pA	
		Full range	100			
V_{ICR} Common-mode input voltage range	$R_S = 50\ \Omega,$ $ V_{IO} \leq 5\text{ mV}$	25°C	0 to 4	-0.3 to 4.2	V	
		Full range	0 to 3.5			
V_{OH} High-level output voltage	$I_{OH} = -20\ \mu\text{A}$	25°C	4.98		V	
	$I_{OH} = -75\ \mu\text{A}$	25°C	4.9	4.94		
	Full range	4.8				
	$I_{OH} = -150\ \mu\text{A}$	25°C	4.8	4.88		
V_{OL} Low-level output voltage	$V_{IC} = 2.5\text{ V},$ $I_{OL} = 50\ \mu\text{A}$	25°C	0.01		V	
	$V_{IC} = 2.5\text{ V},$ $I_{OL} = 500\ \mu\text{A}$	25°C	0.09	0.15		
		Full range	0.15			
	$V_{IC} = 2.5\text{ V},$ $I_{OL} = 1\text{ mA}$	25°C	0.2	0.3		
		Full range	0.3			
	$V_{IC} = 2.5\text{ V},$ $I_{OL} = 4\text{ mA}$	25°C	0.7	1		
		Full range	1.2			
	A_{VD} Large-signal differential voltage amplification	$V_{IC} = 2.5\text{ V},$ $V_O = 1\text{ V to }4\text{ V}$	$R_L = 100\text{ k}\Omega$ ‡	25°C		100
$R_L = 1\text{ M}\Omega$ ‡			Full range	10		
			25°C	1700		
r_{id} Differential input resistance		25°C	10^{12}		Ω	
r_{ic} Common-mode input resistance		25°C	10^{12}		Ω	
c_{ic} Common-mode input capacitance	$f = 10\text{ kHz},$ P package	25°C	8		pF	
z_o Closed-loop output impedance	$f = 25\text{ kHz},$ $A_V = 10$	25°C	200		Ω	
CMRR Common-mode rejection ratio	$V_{IC} = 0\text{ to }2.7\text{ V},$ $V_O = 2.5\text{ V},$ $R_S = 50\ \Omega$	25°C	70	83	dB	
		Full range	70			
k_{SVR} Supply-voltage rejection ratio ($\Delta V_{DD}/\Delta V_{IO}$)	$V_{DD} = 4.4\text{ V to }16\text{ V},$ $V_{IC} = V_{DD}/2,$ No load	25°C	80	95	dB	
		Full range	80			
I_{DD} Supply current	$V_O = 2.5\text{ V},$ No load	25°C	70	125	μA	
		Full range	150			

† Full range is 0°C to 70°C.

‡ Referenced to 2.5 V

NOTE 4: Typical values are based on the input offset voltage shift observed through 500 hours of operating life test at $T_A = 150^\circ\text{C}$ extrapolated to $T_A = 25^\circ\text{C}$ using the Arrhenius equation and assuming an activation energy of 0.96 eV.



TLC225x, TLC225xA
Advanced LinCMOS™ RAIL-TO-RAIL
VERY LOW-POWER OPERATIONAL AMPLIFIERS

SLOS176D – FEBRUARY 1997 – REVISED MARCH 2001

operating characteristics at specified free-air temperature, $V_{DD} = 5\text{ V}$

PARAMETER		TEST CONDITIONS		T_A †	TLC2252C			UNIT
					MIN	TYP	MAX	
SR	Slew rate at unity gain	$V_O = 1.5\text{ V to }3.5\text{ V}, R_L = 100\text{ k}\Omega^\ddagger,$ $C_L = 100\text{ pF}^\ddagger$		25°C	0.07	0.12	$\text{V}/\mu\text{s}$	
				Full range	0.05			
V_n	Equivalent input noise voltage	f = 10 Hz		25°C	36		$\text{nV}/\sqrt{\text{Hz}}$	
		f = 1 kHz		25°C	19			
$V_{N(PP)}$	Peak-to-peak equivalent input noise voltage	f = 0.1 Hz to 1 Hz		25°C	0.7		μV	
		f = 0.1 Hz to 10 Hz		25°C	1.1			
I_n	Equivalent input noise current			25°C	0.6		$\text{fA}/\sqrt{\text{Hz}}$	
THD + N	Total harmonic distortion plus noise	$V_O = 0.5\text{ V to }2.5\text{ V},$ f = 10 kHz, $R_L = 50\text{ k}\Omega^\ddagger$		25°C	$A_V = 1$			
					$A_V = 10$			
	Gain-bandwidth product	f = 10 kHz, $C_L = 100\text{ pF}^\ddagger$	$R_L = 50\text{ k}\Omega^\ddagger,$	25°C	0.2		MHz	
B_{OM}	Maximum output-swing bandwidth	$V_{O(PP)} = 2\text{ V},$ $R_L = 50\text{ k}\Omega^\ddagger,$	$A_V = 1,$ $C_L = 100\text{ pF}^\ddagger$	25°C	30		kHz	
ϕ_m	Phase margin at unity gain	$R_L = 50\text{ k}\Omega^\ddagger,$	$C_L = 100\text{ pF}^\ddagger$	25°C	63°			
	Gain margin			25°C	15		dB	

† Full range is 0°C to 70°C.

‡ Referenced to 2.5 V

TLC225x, TLC225xA
Advanced LinCMOS™ RAIL-TO-RAIL
VERY LOW-POWER OPERATIONAL AMPLIFIERS

SLOS176D – FEBRUARY 1997 – REVISED MARCH 2001

electrical characteristics at specified free-air temperature, $V_{DD\pm} = \pm 5\text{ V}$ (unless otherwise specified)

PARAMETER	TEST CONDITIONS	T _A †	TLC2252C			UNIT
			MIN	TYP	MAX	
V _{IO} Input offset voltage	V _{IC} = 0, V _O = 0, R _S = 50 Ω	25°C	200	1500		μV
		Full range		1750		
αV _{IO} Temperature coefficient of input offset voltage		25°C to 70°C	0.5			μV/°C
Input offset voltage long-term drift (see Note 4)		25°C	0.003			μV/mo
I _{IO} Input offset current		25°C	0.5	60		pA
		Full range		100		
I _{IB} Input bias current		25°C	1	60		pA
		Full range		100		
V _{ICR} Common-mode input voltage range	V _{IO} ≤ 5 mV, R _S = 50 Ω	25°C	-5 to 4	-5.3 to 4.2		V
		Full range	-5 to 3.5			
V _{OM+} Maximum positive peak output voltage	I _O = -20 μA	25°C	4.98		V	
	I _O = -100 μA	25°C	4.9	4.93		
		Full range	4.7			
	I _O = -200 μA	25°C	4.8	4.86		
V _{OM-} Maximum negative peak output voltage	V _{IC} = 0, I _O = 50 μA	25°C	-4.99		V	
		25°C	-4.85	-4.91		
	V _{IC} = 0, I _O = 500 μA	Full range	-4.85			
		25°C	-4.7	-4.8		
	V _{IC} = 0, I _O = 1 mA	Full range	-4.7			
		25°C	-4	-4.3		
	V _{IC} = 0, I _O = 4 mA	Full range	-3.8			
		25°C	45	650		V/mV
A _{VD} Large-signal differential voltage amplification	V _O = ±4 V	R _L = 100 kΩ	Full range	10		
		R _L = 1 MΩ	25°C	3000		
r _{id} Differential input resistance		25°C	10 ¹²	Ω		
r _{ic} Common-mode input resistance		25°C	10 ¹²	Ω		
c _{ic} Common-mode input capacitance	f = 10 kHz, P package	25°C	8	pF		
z _o Closed-loop output impedance	f = 25 kHz, A _V = 10	25°C	190	Ω		
CMRR Common-mode rejection ratio	V _{IC} = -5 V to 2.7 V, V _O = 0, R _S = 50 Ω	25°C	75	88	dB	
		Full range	75			
k _{SVR} Supply-voltage rejection ratio (ΔV _{DD±} /ΔV _{IO})	V _{DD±} = 2.2 V to ±8 V, V _{IC} = 0, No load	25°C	80	95	dB	
		Full range	80			
I _{DD} Supply current	V _O = 0, No load	25°C	80	125	μA	
		Full range		150		

† Full range is 0°C to 70°C.

NOTE 4: Typical values are based on the input offset voltage shift observed through 500 hours of operating life test at T_A = 150°C extrapolated to T_A = 25°C using the Arrhenius equation and assuming an activation energy of 0.96 eV.



TLC225x, TLC225xA
Advanced LinCMOS™ RAIL-TO-RAIL
VERY LOW-POWER OPERATIONAL AMPLIFIERS

SLOS176D – FEBRUARY 1997 – REVISED MARCH 2001

operating characteristics at specified free-air temperature, $V_{DD\pm} = \pm 5\text{ V}$

PARAMETER	TEST CONDITIONS	T_A †	TLC2252C			UNIT
			MIN	TYP	MAX	
SR Slew rate at unity gain	$V_O = \pm 1.9\text{ V}$, $R_L = 100\text{ k}\Omega$, $C_L = 100\text{ pF}$	25°C	0.07	0.12		V/ μs
		Full range	0.05			
V_n Equivalent input noise voltage	$f = 10\text{ Hz}$	25°C	38		nV/ $\sqrt{\text{Hz}}$	
	$f = 1\text{ kHz}$	25°C	19			
$V_{N(PP)}$ Peak-to-peak equivalent input noise voltage	$f = 0.1\text{ Hz to }1\text{ Hz}$	25°C	0.8		μV	
	$f = 0.1\text{ Hz to }10\text{ Hz}$	25°C	1.1			
I_n Equivalent input noise current		25°C	0.6		fA/ $\sqrt{\text{Hz}}$	
THD + N Total harmonic distortion pulse duration	$V_O = \pm 2.3\text{ V}$, $f = 10\text{ kHz}$, $R_L = 50\text{ k}\Omega$	$A_V = 1$	0.2%			
		$A_V = 10$	1%			
Gain-bandwidth product	$f = 10\text{ kHz}$, $R_L = 50\text{ k}\Omega$, $C_L = 100\text{ pF}$	25°C	0.21		MHz	
B_{OM} Maximum output-swing bandwidth	$V_{O(PP)} = 4.6\text{ V}$, $R_L = 50\text{ k}\Omega$, $A_V = 1$, $C_L = 100\text{ pF}$	25°C	14		kHz	
ϕ_m Phase margin at unity gain	$R_L = 50\text{ k}\Omega$, $C_L = 100\text{ pF}$	25°C	63°			
Gain margin		25°C	15		dB	

† Full range is 0°C to 70°C.

TLC225x, TLC225xA
Advanced LinCMOS™ RAIL-TO-RAIL
VERY LOW-POWER OPERATIONAL AMPLIFIERS

SLOS176D – FEBRUARY 1997 – REVISED MARCH 2001

electrical characteristics at specified free-air temperature, $V_{DD} = 5\text{ V}$ (unless otherwise noted)

PARAMETER	TEST CONDITIONS	T_A †	TLC2254C			UNIT
			MIN	TYP	MAX	
V_{IO} Input offset voltage	$V_{IC} = 0,$ $V_O = 0,$ $V_{DD\pm} = \pm 2.5\text{ V},$ $R_S = 50\ \Omega$	25°C	200	1500		μV
		Full range		1750		
$\alpha_{V_{IO}}$ Temperature coefficient of input offset voltage		25°C to 70°C	0.5			$\mu\text{V}/^\circ\text{C}$
Input offset voltage long-term drift (see Note 4)		25°C	0.003			$\mu\text{V}/\text{mo}$
I_{IO} Input offset current		25°C	0.5	60		pA
		Full range		100		
I_{IB} Input bias current		25°C	1	60		pA
		Full range		100		
V_{ICR} Common-mode input voltage range	$R_S = 50\ \Omega,$ $ V_{IO} \leq 5\text{ mV}$	25°C	0 to 4	-0.3 to 4.2		V
		Full range	0 to 3.5			
V_{OH} High-level output voltage	$I_{OH} = -20\ \mu\text{A}$ $I_{OH} = -75\ \mu\text{A}$ $I_{OH} = -150\ \mu\text{A}$	25°C		4.98		V
		25°C	4.9	4.94		
		Full range	4.8			
		25°C	4.8	4.88		
V_{OL} Low-level output voltage	$V_{IC} = 2.5\text{ V},$ $I_{OL} = 50\ \mu\text{A}$ $I_{OL} = 500\ \mu\text{A}$ $I_{OL} = 1\text{ mA}$ $I_{OL} = 4\text{ mA}$	25°C	0.01			V
		25°C	0.09	0.15		
		Full range		0.15		
		25°C	0.2	0.3		
		Full range		0.3		
		25°C	0.7	1		
A_{VD} Large-signal differential voltage amplification	$V_{IC} = 2.5\text{ V},$ $V_O = 1\text{ V to }4\text{ V}$	$R_L = 100\ \text{k}\Omega\ddagger$	25°C	100	350	V/mV
			Full range	10		
		$R_L = 1\ \text{M}\Omega\ddagger$	25°C		1700	
$r_{i(d)}$ Differential input resistance		25°C		10^{12}	Ω	
$r_{i(c)}$ Common-mode input resistance		25°C		10^{12}	Ω	
$c_{i(c)}$ Common-mode input capacitance	$f = 10\text{ kHz},$ N package	25°C		8	pF	
z_o Closed-loop output impedance	$f = 25\text{ kHz},$ $A_V = 10$	25°C		200	Ω	
CMRR Common-mode rejection ratio	$V_{IC} = 0\text{ to }2.7\text{ V},$ $V_O = 2.5\text{ V},$ $R_S = 50\ \Omega$	25°C	70	83	dB	
		Full range	70			
k_{SVR} Supply-voltage rejection ratio ($\Delta V_{DD}/\Delta V_{IO}$)	$V_{DD} = 4.4\text{ V to }16\text{ V},$ $V_{IC} = V_{DD}/2,$ No load	25°C	80	95	dB	
		Full range	80			
I_{DD} Supply current (four amplifiers)	$V_O = 2.5\text{ V},$ No load	25°C	140	250	μA	
		Full range		300		

† Full range is 0°C to 70°C.

‡ Referenced to 2.5 V

NOTE 4: Typical values are based on the input offset voltage shift observed through 500 hours of operating life test at $T_A = 150^\circ\text{C}$ extrapolated to $T_A = 25^\circ\text{C}$ using the Arrhenius equation and assuming an activation energy of 0.96 eV.



TLC225x, TLC225xA
Advanced LinCMOS™ RAIL-TO-RAIL
VERY LOW-POWER OPERATIONAL AMPLIFIERS

SLOS176D – FEBRUARY 1997 – REVISED MARCH 2001

operating characteristics at specified free-air temperature, $V_{DD} = 5\text{ V}$

PARAMETER		TEST CONDITIONS		T_A †	TLC2254C			UNIT
					MIN	TYP	MAX	
SR	Slew rate at unity gain	$V_O = 1.4\text{ V to }2.6\text{ V}$ $R_L = 100\text{ k}\Omega$ ‡, $C_L = 100\text{ pF}$ ‡		25°C	0.07	0.12	$\text{V}/\mu\text{s}$	
				Full range	0.05			
V_n	Equivalent input noise voltage			25°C	36		$\text{nV}/\sqrt{\text{Hz}}$	
				25°C	19			
$V_{N(PP)}$	Peak-to-peak equivalent input noise voltage			25°C	0.7		μV	
				25°C	1.1			
I_n	Equivalent input noise current			25°C	0.6		$\text{fA}/\sqrt{\text{Hz}}$	
THD + N	Total harmonic distortion plus noise	$V_O = 0.5\text{ V to }2.5\text{ V}$, $f = 10\text{ kHz}$, $R_L = 50\text{ k}\Omega$ ‡		25°C	$A_V = 1$			
					$A_V = 10$			
	Gain-bandwidth product	$f = 10\text{ kHz}$, $C_L = 100\text{ pF}$ ‡	$R_L = 50\text{ k}\Omega$ ‡,	25°C	0.2		MHz	
BOM	Maximum output-swing bandwidth	$V_{O(PP)} = 2\text{ V}$, $R_L = 50\text{ k}\Omega$ ‡,	$A_V = 1$, $C_L = 100\text{ pF}$ ‡	25°C	30		kHz	
ϕ_m	Phase margin at unity gain	$R_L = 50\text{ k}\Omega$ ‡,	$C_L = 100\text{ pF}$ ‡	25°C	63°			
	Gain margin			25°C	15		dB	

† Full range is 0°C to 70°C.

‡ Referenced to 2.5 V

TLC225x, TLC225xA
Advanced LinCMOS™ RAIL-TO-RAIL
VERY LOW-POWER OPERATIONAL AMPLIFIERS

SLOS176D – FEBRUARY 1997 – REVISED MARCH 2001

electrical characteristics at specified free-air temperature, $V_{DD\pm} = \pm 5$ V (unless otherwise specified)

PARAMETER	TEST CONDITIONS	T _A †	TLC2254C			UNIT
			MIN	TYP	MAX	
V _{IO} Input offset voltage	V _{IC} = 0, V _O = 0, R _S = 50 Ω	25°C	200	1500	μV	
		Full range	1750			
α _{VIO} Temperature coefficient of input offset voltage		25°C to 70°C	0.5		μV/°C	
Input offset voltage long-term drift (see Note 4)		25°C	0.003		μV/mo	
I _{IO} Input offset current		25°C	0.5	60	pA	
		Full range	100			
I _{IB} Input bias current		25°C	1	60	pA	
		Full range	100			
V _{ICR} Common-mode input voltage range	V _{IO} ≤ 5 mV, R _S = 50 Ω	25°C	-5 to 4	-5.3 to 4.2	V	
		Full range	-5 to 3.5			
V _{OM+} Maximum positive peak output voltage	I _O = -20 μA	25°C	4.98		V	
	I _O = -100 μA	25°C	4.9	4.93		
		Full range	4.7			
	I _O = -200 μA	25°C	4.8	4.86		
V _{OM-} Maximum negative peak output voltage	V _{IC} = 0, I _O = 50 μA	25°C	-4.99		V	
		Full range	-4.85			
	V _{IC} = 0, I _O = 500 μA	25°C	-4.85	-4.91		
		Full range	-4.85			
	V _{IC} = 0, I _O = 1 mA	25°C	-4.7	-4.8		
		Full range	-4.7			
	V _{IC} = 0, I _O = 4 mA	25°C	-4	-4.3		
		Full range	-3.8			
A _{VD} Large-signal differential voltage amplification	V _O = ±4 V	R _L = 100 kΩ	25°C	40	150	V/mV
		R _L = 1 MΩ	Full range	10		
			25°C	3000		
r _{i(d)} Differential input resistance		25°C	10 ¹²		Ω	
r _{i(c)} Common-mode input resistance		25°C	10 ¹²		Ω	
c _{i(c)} Common-mode input capacitance	f = 10 kHz, N package	25°C	8		pF	
z _O Closed-loop output impedance	f = 25 kHz, A _V = 10	25°C	190		Ω	
CMRR Common-mode rejection ratio	V _{IC} = -5 V to 2.7 V, V _O = 0, R _S = 50 Ω	25°C	75	88	dB	
		Full range	75			
k _{SVR} Supply-voltage rejection ratio (ΔV _{DD±} /ΔV _{IO})	V _{DD±} = ±2.2 V to ±8 V, V _{IC} = 0, No load	25°C	80	95	dB	
		Full range	80			
I _{DD} Supply current (four amplifiers)	V _O = 0, No load	25°C	160	250	μA	
		Full range	300			

† Full range is 0°C to 70°C.

NOTE 4: Typical values are based on the input offset voltage shift observed through 500 hours of operating life test at T_A = 150°C extrapolated to T_A = 25°C using the Arrhenius equation and assuming an activation energy of 0.96 eV.



TLC225x, TLC225xA
Advanced LinCMOS™ RAIL-TO-RAIL
VERY LOW-POWER OPERATIONAL AMPLIFIERS

SLOS176D – FEBRUARY 1997 – REVISED MARCH 2001

operating characteristics at specified free-air temperature, $V_{DD\pm} = \pm 5\text{ V}$

PARAMETER		TEST CONDITIONS		T_A †	TLC2254C			UNIT
					MIN	TYP	MAX	
SR	Slew rate at unity gain	$V_O = \pm 1.9\text{ V}$, $C_L = 100\text{ pF}$	$R_L = 100\text{ k}\Omega$	25°C	0.07	0.12	$\text{V}/\mu\text{s}$	
				Full range	0.05			
V_n	Equivalent input noise voltage			25°C	38		$\text{nV}/\sqrt{\text{Hz}}$	
				25°C	19			
$V_{N(PP)}$	Peak-to-peak equivalent input noise voltage			25°C	0.8		μV	
				25°C	1.1			
I_n	Equivalent input noise current			25°C	0.6		$\text{fA}/\sqrt{\text{Hz}}$	
THD + N	Total harmonic distortion plus noise	$V_O = \pm 2.3\text{ V}$, $f = 20\text{ kHz}$, $R_L = 50\text{ k}\Omega$		25°C	$A_V = 1$			
					$A_V = 10$			
	Gain-bandwidth product	$f = 10\text{ kHz}$, $C_L = 100\text{ pF}$	$R_L = 50\text{ k}\Omega$	25°C	0.21		MHz	
B_{OM}	Maximum output-swing bandwidth	$V_{O(PP)} = 4.6\text{ V}$, $R_L = 50\text{ k}\Omega$	$A_V = 1$, $C_L = 100\text{ pF}$	25°C	14		kHz	
ϕ_m	Phase margin at unity gain	$R_L = 50\text{ k}\Omega$	$C_L = 100\text{ pF}$	25°C	63°			
	Gain margin			25°C	15		dB	

† Full range is 0°C to 70°C.

TLC225x, TLC225xA
Advanced LinCMOS™ RAIL-TO-RAIL
VERY LOW-POWER OPERATIONAL AMPLIFIERS

SLOS176D – FEBRUARY 1997 – REVISED MARCH 2001

electrical characteristics at specified free-air temperature, $V_{DD} = 5\text{ V}$ (unless otherwise noted)

PARAMETER	TEST CONDITIONS	T_A †	TLC2252I			TLC2252AI			UNIT
			MIN	TYP	MAX	MIN	TYP	MAX	
V_{IO} Input offset voltage	$V_{DD} = \pm 2.5\text{ V}$, $V_O = 0$, $V_{IC} = 0$, $R_S = 50\ \Omega$	25°C	200	1500		200	850	μV	
		Full range		1750		1000			
α_{VIO} Temperature coefficient of input offset voltage		25°C to 85°C	0.5			0.5			$\mu\text{V}/^\circ\text{C}$
Input offset voltage long-term drift (see Note 4)		25°C	0.003			0.003			$\mu\text{V}/\text{mo}$
I_{IO} Input offset current		25°C	0.5	60		0.5	60	pA	
		Full range		1000		1000			
I_{IB} Input bias current	25°C	1	60		1	60	pA		
	Full range		1000		1000				
V_{ICR} Common-mode input voltage range	$R_S = 50\ \Omega$, $ V_{IO} \leq 5\text{ mV}$	25°C	0 to 4	-0.3 to 4.2		0 to 4	-0.3 to 4.2	V	
		Full range	3.5			3.5			
V_{OH} High-level output voltage	$I_{OH} = -20\ \mu\text{A}$	25°C	4.98		4.98		V		
	$I_{OH} = -75\ \mu\text{A}$	25°C	4.9	4.94	4.9	4.94			
	Full range	4.8		4.8					
V_{OL} Low-level output voltage	$V_{IC} = 2.5\text{ V}$, $I_{OL} = 50\ \mu\text{A}$	25°C	0.01		0.01		V		
	$V_{IC} = 2.5\text{ V}$, $I_{OL} = 500\ \mu\text{A}$	25°C	0.09	0.15	0.09	0.15			
		Full range	0.15		0.15				
	$V_{IC} = 2.5\text{ V}$, $I_{OL} = 4\text{ mA}$	25°C	0.8	1	0.7	1			
		Full range	1.2		1.2				
A_{VD} Large-signal differential voltage amplification	$V_{IC} = 2.5\text{ V}$, $V_O = 1\text{ V to }4\text{ V}$	$R_L = 100\text{ k}\Omega$ ‡	25°C	100	350	100	350	V/mV	
		$R_L = 1\text{ M}\Omega$ ‡	Full range	10		10			
			25°C	1700		1700			
r_{id} Differential input resistance		25°C	10^{12}		10^{12}		Ω		
r_{ic} Common-mode input resistance		25°C	10^{12}		10^{12}		Ω		
C_{ic} Common-mode input capacitance	$f = 10\text{ kHz}$, P package	25°C	8		8		pF		
z_o Closed-loop output impedance	$f = 25\text{ kHz}$, $A_V = 10$	25°C	200		200		Ω		
CMRR Common-mode rejection ratio	$V_{IC} = 0\text{ to }2.7\text{ V}$, $V_O = 2.5\text{ V}$, $R_S = 50\ \Omega$	25°C	70	83	70	83	dB		
		Full range	70		70				
kSVR Supply-voltage rejection ratio ($\Delta V_{DD}/\Delta V_{IO}$)	$V_{DD} = 4.4\text{ V to }16\text{ V}$, $V_{IC} = V_{DD}/2$, No load	25°C	80	95	80	95	dB		
		Full range	80		80				
I_{DD} Supply current	$V_O = 2.5\text{ V}$, No load	25°C	70	125	70	125	μA		
		Full range	150		150				

† Full range is -40°C to 125°C .

‡ Referenced to 2.5 V

NOTE 4: Typical values are based on the input offset voltage shift observed through 500 hours of operating life test at $T_A = 150^\circ\text{C}$ extrapolated to $T_A = 25^\circ\text{C}$ using the Arrhenius equation and assuming an activation energy of 0.96 eV.



TLC225x, TLC225xA
Advanced LinCMOS™ RAIL-TO-RAIL
VERY LOW-POWER OPERATIONAL AMPLIFIERS

SLOS176D – FEBRUARY 1997 – REVISED MARCH 2001

operating characteristics at specified free-air temperature, $V_{DD} = 5\text{ V}$

PARAMETER	TEST CONDITIONS	T_A †	TLC2252I			TLC2252AI			UNIT	
			MIN	TYP	MAX	MIN	TYP	MAX		
SR	Slew rate at unity gain $V_O = 1.5\text{ V to }3.5\text{ V}$, $R_L = 100\text{ k}\Omega$ ‡, $C_L = 100\text{ pF}$ ‡	25°C	0.07	0.12		0.07	0.12		V/ μs	
		Full range	0.05			0.05				
V_n	Equivalent input noise voltage	f = 10 Hz	25°C			36			nV/ $\sqrt{\text{Hz}}$	
		f = 1 kHz	25°C			19				
$V_{N(PP)}$	Peak-to-peak equivalent input noise voltage	f = 0.1 Hz to 1 Hz	25°C			0.7			μV	
		f = 0.1 Hz to 10 Hz	25°C			1.1				
I_n	Equivalent input noise current	25°C	0.6			0.6			fA/ $\sqrt{\text{Hz}}$	
THD + N	Total harmonic distortion plus noise $V_O = 0.5\text{ V to }2.5\text{ V}$, f = 10 kHz, $R_L = 50\text{ k}\Omega$ ‡	$A_V = 1$	25°C			0.2%				
		$A_V = 10$	25°C			1%				
	Gain-bandwidth product	f = 50 kHz, $C_L = 100\text{ pF}$ ‡	$R_L = 50\text{ k}\Omega$ ‡,	25°C			0.2			MHz
BOM	Maximum output-swing bandwidth	$V_{O(PP)} = 2\text{ V}$, $R_L = 50\text{ k}\Omega$ ‡,	$A_V = 1$, $R_L = 50\text{ k}\Omega$ ‡,	25°C			30			kHz
ϕ_m	Phase margin at unity gain	$R_L = 50\text{ k}\Omega$ ‡,	$C_L = 100\text{ pF}$ ‡	25°C			63°			
				25°C			15			15

† Full range is –40°C to 125°C.

‡ Referenced to 2.5 V

TLC225x, TLC225xA
Advanced LinCMOS™ RAIL-TO-RAIL
VERY LOW-POWER OPERATIONAL AMPLIFIERS

SLOS176D – FEBRUARY 1997 – REVISED MARCH 2001

electrical characteristics at specified free-air temperature, $V_{DD\pm} = \pm 5$ V (unless otherwise noted)

PARAMETER	TEST CONDITIONS	T_A †	TLC2252I			TLC2252AI			UNIT
			MIN	TYP	MAX	MIN	TYP	MAX	
V_{IO} Input offset voltage	$V_{IC} = 0, V_O = 0, R_S = 50 \Omega$	25°C	200	1500		200	850	μV	
		Full range			1750		1000		
α_{VIO} Temperature coefficient of input offset voltage		25°C to 85°C	0.5			0.5		$\mu V/^\circ C$	
Input offset voltage long-term drift (see Note 4)		25°C	0.003			0.003		$\mu V/mo$	
I_{IO} Input offset current		25°C	0.5	60		0.5	60	pA	
		Full range			1000		1000		
I_{IB} Input bias current	25°C	1	60		1	60	pA		
	Full range			1000		1000			
V_{ICR} Common-mode input voltage range	$R_S = 50 \Omega, V_{IO} \leq 5 mV$	25°C	-5 to 4	-5.3 to 4.2		-5 to 4	-5.3 to 4.2	V	
		Full range	-5 to 3.5			-5 to 3.5			
V_{OM+} Maximum positive peak output voltage	$I_O = -20 \mu A$	25°C		4.98		4.98	V		
	$I_O = -100 \mu A$	25°C	4.9	4.93		4.9		4.93	
		Full range		4.7				4.7	
	$I_O = -200 \mu A$	25°C	4.8	4.86		4.8		4.86	
V_{OM-} Maximum negative peak output voltage	$V_{IC} = 0, I_O = 50 \mu A$	25°C		-4.99		-4.99	V		
	$V_{IC} = 0, I_O = 500 \mu A$	25°C	-4.85	-4.91		-4.85		-4.91	
		Full range		-4.85				-4.85	
	$V_{IC} = 0, I_O = 4 mA$	25°C	-4	-4.3		-4		-4.3	
AVD Large-signal differential voltage amplification	$V_O = \pm 4 V$	$R_L = 50 k\Omega$	25°C	40	150		40	150	V/mV
			Full range		10			10	
			$R_L = 1 M\Omega$	25°C		3000			
r_{id} Differential input resistance		25°C		10 ¹²			10 ¹²	Ω	
r_{ic} Common-mode input resistance		25°C		10 ¹²			10 ¹²	Ω	
C_{ic} Common-mode input capacitance	f = 10 kHz, P package	25°C		8			8	pF	
Z_o Closed-loop output impedance	f = 25 kHz, $A_V = 10$	25°C		190			190	Ω	
CMRR Common-mode rejection ratio	$V_{IC} = -5 V$ to 2.7 V, $V_O = 0, R_S = 50 \Omega$	25°C	75	88		75	88	dB	
		Full range		75			75		
k_{SVR} Supply-voltage rejection ratio ($\Delta V_{DD\pm} / \Delta V_{IO}$)	$V_{DD} = 4.4 V$ to 16 V, $V_{IC} = V_{DD}/2$, No load	25°C	80	95		80	95	dB	
		Full range		80			80		
I_{DD} Supply current	$V_O = 2.5 V$, No load	25°C	80	125		80	125	μA	
		Full range			150				150

† Full range is -40°C to 125°C.

NOTE 4: Typical values are based on the input offset voltage shift observed through 500 hours of operating life test at $T_A = 150^\circ C$ extrapolated to $T_A = 25^\circ C$ using the Arrhenius equation and assuming an activation energy of 0.96 eV.



TLC225x, TLC225xA
Advanced LinCMOS™ RAIL-TO-RAIL
VERY LOW-POWER OPERATIONAL AMPLIFIERS

SLOS176D – FEBRUARY 1997 – REVISED MARCH 2001

operating characteristics at specified free-air temperature, $V_{DD\pm} = \pm 5\text{ V}$

PARAMETER	TEST CONDITIONS	T_A †	TLC2252I			TLC2252AI			UNIT	
			MIN	TYP	MAX	MIN	TYP	MAX		
SR	Slew rate at unity gain $V_O = \pm 1.9\text{ V}$, $R_L = 100\text{ k}\Omega$, $C_L = 100\text{ pF}$	25°C	0.07	0.12		0.07	0.12		V/ μs	
		Full range	0.05			0.05				
V_n	Equivalent input noise voltage	f = 10 Hz	25°C			38			nV/ $\sqrt{\text{Hz}}$	
		f = 1 kHz	25°C			19				
$V_{N(PP)}$	Peak-to-peak equivalent input noise voltage	f = 0.1 Hz to 1 Hz	25°C			0.8			μV	
		f = 0.1 Hz to 10 Hz	25°C			1.1				
I_n	Equivalent input noise current	25°C	0.6			0.6			fA/ $\sqrt{\text{Hz}}$	
THD + N	Total harmonic distortion plus noise	$V_O = \pm 2.3\text{ V}$, $R_L = 50\text{ k}\Omega$, f = 10 kHz	$A_V = 1$	25°C			0.2%			
			$A_V = 10$	25°C			1%			
	Gain-bandwidth product	f = 10 kHz, $C_L = 100\text{ pF}$, $R_L = 50\text{ k}\Omega$	25°C			0.21			MHz	
BOM	Maximum output-swing bandwidth	$V_{O(PP)} = 4.6\text{ V}$, $A_V = 1$, $R_L = 50\text{ k}\Omega$, $C_L = 100\text{ pF}$	25°C			14			kHz	
ϕ_m	Phase margin at unity gain	$R_L = 50\text{ k}\Omega$, $C_L = 100\text{ pF}$	25°C			63°				
	Gain margin		25°C			15			dB	

† Full range is -40°C to 125°C .

TLC225x, TLC225xA
Advanced LinCMOS™ RAIL-TO-RAIL
VERY LOW-POWER OPERATIONAL AMPLIFIERS

SLOS176D – FEBRUARY 1997 – REVISED MARCH 2001

electrical characteristics at specified free-air temperature, $V_{DD} = 5\text{ V}$ (unless otherwise noted)

PARAMETER	TEST CONDITIONS	T_A †	TLC2254I			TLC2254AI			UNIT	
			MIN	TYP	MAX	MIN	TYP	MAX		
V_{IO} Input offset voltage		25°C	200	1500		200	850	μV		
		Full range		1750		1000				
α_{VIO} Temperature coefficient of input offset voltage	$V_{DD} \pm = \pm 2.5\text{ V}$, $V_{IC} = 0$, $V_O = 0$, $R_S = 50\ \Omega$	25°C to 125°C	0.5			0.5			$\mu\text{V}/^\circ\text{C}$	
Input offset voltage long-term drift (see Note 4)		25°C	0.003			0.003			$\mu\text{V}/\text{mo}$	
I_{IO} Input offset current		25°C	0.5	60		0.5	60	pA		
		Full range		1000		1000				
I_{IB} Input bias current	25°C	1	60		1	60	pA			
	Full range		1000		1000					
V_{ICR} Common-mode input voltage range	$R_S = 50\ \Omega$, $ V_{IO} \leq 5\text{ mV}$	25°C	0 to 4	-0.3 to 4.2		0 to 4	-0.3 to 4.2	V		
		Full range	0 to 3.5		0 to 3.5					
V_{OH} High-level output voltage	$I_{OH} = -20\ \mu\text{A}$	25°C	4.98			4.98			V	
	$I_{OH} = -75\ \mu\text{A}$	25°C	4.9	4.94		4.9	4.94			
	Full range		4.8			4.8				
V_{OL} Low-level output voltage	$V_{IC} = 2.5\text{ V}$, $I_{OL} = 50\ \mu\text{A}$	25°C	0.01			0.01			V	
	$V_{IC} = 2.5\text{ V}$, $I_{OL} = 500\ \mu\text{A}$	25°C	0.09	0.15		0.09	0.15			
	Full range		0.15			0.15				
	$V_{IC} = 2.5\text{ V}$, $I_{OL} = 4\text{ mA}$	25°C	0.8	1		0.7	1			
A_{VD} Large-signal differential voltage amplification	$V_{IC} = 2.5\text{ V}$, $V_O = 1\text{ V to }4\text{ V}$	$R_L = 100\text{ k}\Omega$ ‡	25°C	100	350		100	350	V/mV	
		Full range		10			10			
		$R_L = 1\text{ M}\Omega$ ‡	25°C	1700			1700			
$r_{i(d)}$ Differential input resistance		25°C	10^{12}			10^{12}			Ω	
$r_{i(c)}$ Common-mode input resistance		25°C	10^{12}			10^{12}			Ω	
$C_{i(c)}$ Common-mode input capacitance	$f = 10\text{ kHz}$, N package	25°C	8			8			pF	
z_o Closed-loop output impedance	$f = 25\text{ kHz}$, $A_V = 10$	25°C	200			200			Ω	
CMRR Common-mode rejection ratio	$V_{IC} = 0\text{ to }2.7\text{ V}$, $V_O = 2.5\text{ V}$, $R_S = 50\ \Omega$	25°C	70	83		70	83	dB		
		Full range	70			70				
k_{SVR} Supply-voltage rejection ratio ($\Delta V_{DD}/\Delta V_{IO}$)	$V_{DD} = 4.4\text{ V to }16\text{ V}$, $V_{IC} = V_{DD}/2$, No load	25°C	80	95		80	95	dB		
		Full range	80			80				
I_{DD} Supply current (four amplifiers)	$V_O = 2.5\text{ V}$, No load	25°C	140	250		140	250	μA		
		Full range	300			300				

† Full range is -40°C to 125°C .

‡ Referenced to 2.5 V

NOTE 4: Typical values are based on the input offset voltage shift observed through 500 hours of operating life test at $T_A = 150^\circ\text{C}$ extrapolated to $T_A = 25^\circ\text{C}$ using the Arrhenius equation and assuming an activation energy of 0.96 eV.



TLC225x, TLC225xA
Advanced LinCMOS™ RAIL-TO-RAIL
VERY LOW-POWER OPERATIONAL AMPLIFIERS

SLOS176D – FEBRUARY 1997 – REVISED MARCH 2001

operating characteristics at specified free-air temperature, $V_{DD} = 5\text{ V}$

PARAMETER	TEST CONDITIONS	T_A †	TLC2254I			TLC2254AI			UNIT	
			MIN	TYP	MAX	MIN	TYP	MAX		
SR	Slew rate at unity gain $V_O = 1.4\text{ V to }2.6\text{ V}$, $R_L = 100\text{ k}\Omega$ ‡, $C_L = 100\text{ pF}$ ‡	25°C	0.07	0.12		0.07	0.12		V/ μs	
		Full range	0.05			0.05				
V_n	Equivalent input noise voltage $f = 10\text{ Hz}$ $f = 1\text{ kHz}$	25°C	36			36			nV/ $\sqrt{\text{Hz}}$	
		25°C	19			19				
$V_{N(PP)}$	Peak-to-peak equivalent input noise voltage $f = 0.1\text{ Hz to }1\text{ Hz}$ $f = 0.1\text{ Hz to }10\text{ Hz}$	25°C	0.7			0.7			μV	
		25°C	1.1			1.1				
I_n	Equivalent input noise current	25°C	0.6			0.6			fA/ $\sqrt{\text{Hz}}$	
THD + N	Total harmonic distortion plus noise $V_O = 0.5\text{ V to }2.5\text{ V}$, $f = 20\text{ kHz}$, $R_L = 50\text{ k}\Omega$ ‡	$A_V = 1$	0.2%			0.2%				
		$A_V = 10$	1%			1%				
	Gain-bandwidth product $f = 50\text{ kHz}$, $C_L = 100\text{ pF}$ ‡	$R_L = 50\text{ k}\Omega$ ‡, 25°C	0.2			0.2			MHz	
BOM	Maximum output-swing bandwidth $V_{O(PP)} = 2\text{ V}$, $R_L = 50\text{ k}\Omega$ ‡,	$A_V = 1$, $C_L = 100\text{ pF}$ ‡	25°C	30			30			kHz
ϕ_m	Phase margin at unity gain $R_L = 50\text{ k}\Omega$ ‡,	$C_L = 100\text{ pF}$ ‡	25°C	63°			63°			
	Gain margin		25°C	15			15			dB

† Full range is –40°C to 125°C.

‡ Referenced to 2.5 V

TLC225x, TLC225xA
Advanced LinCMOS™ RAIL-TO-RAIL
VERY LOW-POWER OPERATIONAL AMPLIFIERS

SLOS176D – FEBRUARY 1997 – REVISED MARCH 2001

electrical characteristics at specified free-air temperature, $V_{DD\pm} = \pm 5$ V (unless otherwise noted)

PARAMETER	TEST CONDITIONS	T_A †	TLC2254I			TLC2254AI			UNIT
			MIN	TYP	MAX	MIN	TYP	MAX	
V_{IO} Input offset voltage	$V_{IC} = 0, V_O = 0, R_S = 50 \Omega$	25°C	200	1500		200	850	μV	
		Full range			1750		1000		
α_{VIO} Temperature coefficient of input offset voltage		25°C to 125°C	0.5			0.5		$\mu V/^\circ C$	
Input offset voltage long-term drift (see Note 4)		25°C	0.003			0.003		$\mu V/mo$	
I_{IO} Input offset current		25°C	0.5	60		0.5	60	pA	
		Full range			1000		1000		
I_{IB} Input bias current	25°C	1	60		1	60	pA		
	Full range			1000		1000			
V_{ICR} Common-mode input voltage range	$R_S = 50 \Omega, V_{IO} \leq 5$ mV	25°C	-5 to 4	-5.3 to 4.2		-5 to 4	-5.3 to 4.2	V	
		Full range	-5 to 3.5			-5 to 3.5			
V_{OM+} Maximum positive peak output voltage	$I_O = -20 \mu A$	25°C		4.98			4.98	V	
	$I_O = -100 \mu A$	25°C	4.9	4.93		4.9	4.93		
		Full range		4.7			4.7		
	$I_O = -200 \mu A$	25°C	4.8	4.86		4.8	4.86		
V_{OM-} Maximum negative peak output voltage	$V_{IC} = 0, I_O = 50 \mu A$	25°C		-4.99			-4.99	V	
	$V_{IC} = 0, I_O = 500 \mu A$	25°C	-4.85	-4.91		-4.85	-4.91		
		Full range		-4.85			-4.85		
	$V_{IC} = 0, I_O = 4$ mA	25°C	-4	-4.3		-4	-4.3		
A_{VD} Large-signal differential voltage amplification	$V_O = \pm 4$ V	$R_L = 100$ k Ω	25°C	40	150		40	150	V/mV
			Full range		10			10	
		$R_L = 1$ M Ω	25°C		3000			3000	
$r_{i(d)}$ Differential input resistance		25°C		10^{12}			10^{12}	Ω	
$r_{i(c)}$ Common-mode input resistance		25°C		10^{12}			10^{12}	Ω	
$C_{i(c)}$ Common-mode input capacitance	$f = 10$ kHz, N package	25°C		8			8	pF	
z_o Closed-loop output impedance	$f = 25$ kHz, $A_V = 10$	25°C		190			190	Ω	
CMRR Common-mode rejection ratio	$V_{IC} = -5$ V to 2.7 V, $V_O = 0, R_S = 50 \Omega$	25°C	75	88		75	88	dB	
		Full range		75			75		
k_{SVR} Supply-voltage rejection ratio ($\Delta V_{DD\pm}/\Delta V_{IO}$)	$V_{DD\pm} = \pm 2.2$ V to ± 8 V, $V_{IC} = V_{DD}/2$, No load	25°C	80	95		80	95	dB	
		Full range		80			80		
I_{DD} Supply current (four amplifiers)	$V_O = 0$, No load	25°C	160	250		160	250	μA	
		Full range			300		300		

† Full range is -40°C to 125°C.

NOTE 4: Typical values are based on the input offset voltage shift observed through 500 hours of operating life test at $T_A = 150^\circ C$ extrapolated to $T_A = 25^\circ C$ using the Arrhenius equation and assuming an activation energy of 0.96 eV.



TLC225x, TLC225xA
Advanced LinCMOS™ RAIL-TO-RAIL
VERY LOW-POWER OPERATIONAL AMPLIFIERS

SLOS176D – FEBRUARY 1997 – REVISED MARCH 2001

operating characteristics at specified free-air temperature, $V_{DD\pm} = \pm 5\text{ V}$

PARAMETER	TEST CONDITIONS	T_A †	TLC2254I			TLC2254AI			UNIT
			MIN	TYP	MAX	MIN	TYP	MAX	
SR	Slew rate at unity gain $V_O = \pm 1.9\text{ V}$, $C_L = 100\text{ pF}$, $R_L = 100\text{ k}\Omega$	25°C	0.07	0.12		0.07	0.12		V/ μs
		Full range	0.05			0.05			
V_n	Equivalent input noise voltage	25°C	38			38			nV/ $\sqrt{\text{Hz}}$
		25°C	19			19			
$V_{N(PP)}$	Peak-to-peak equivalent input noise voltage	25°C	0.8			0.8			μV
		25°C	1.1			1.1			
I_n	Equivalent input noise current	25°C	0.6			0.6			fA/ $\sqrt{\text{Hz}}$
THD + N	Total harmonic distortion plus noise $V_O = \pm 2.3\text{ V}$, $R_L = 50\text{ k}\Omega$, $f = 20\text{ kHz}$	25°C	0.2%			0.2%			
			1%			1%			
	Gain-bandwidth product $f = 10\text{ kHz}$, $C_L = 100\text{ pF}$, $R_L = 50\text{ k}\Omega$	25°C	0.21			0.21			MHz
BOM	Maximum output-swing bandwidth $V_{O(PP)} = 4.6\text{ V}$, $R_L = 50\text{ k}\Omega$, $A_V = 1$, $C_L = 100\text{ pF}$	25°C	14			14			kHz
ϕ_m	Phase margin at unity gain $R_L = 50\text{ k}\Omega$, $C_L = 100\text{ pF}$	25°C	63°			63°			
		25°C	15			15			

† Full range is -40°C to 125°C .

TLC225x, TLC225xA Advanced LinCMOS™ RAIL-TO-RAIL VERY LOW-POWER OPERATIONAL AMPLIFIERS

SLOS176D – FEBRUARY 1997 – REVISED MARCH 2001

electrical characteristics at specified free-air temperature, $V_{DD} = 5\text{ V}$ (unless otherwise noted)

PARAMETER	TEST CONDITIONS	T_A †	TLC2252Q TLC2252M			TLC2252AQ TLC2252AM			UNIT	
			MIN	TYP	MAX	MIN	TYP	MAX		
V_{IO} Input offset voltage	$V_{DD\pm} = \pm 2.5\text{ V}$, $V_O = 0$, $V_{IC} = 0$, $R_S = 50\ \Omega$	25°C	200	1500		200	850	μV		
		Full range			1750		1000			
α_{VIO} Temperature coefficient of input offset voltage		25°C to 125°C	0.5			0.5			$\mu\text{V}/^\circ\text{C}$	
Input offset voltage long-term drift (see Note 4)		25°C	0.003			0.003			$\mu\text{V}/\text{mo}$	
I_{IO} Input offset current		25°C	0.5	60		0.5	60	pA		
		Full range			1000		1000			
I_{IB} Input bias current	25°C	1	60		1	60	pA			
	Full range			1000		1000				
V_{ICR} Common-mode input voltage range	$R_S = 50\ \Omega$, $ V_{IO} \leq 5\text{ mV}$	25°C	0 to 4	-0.3 to 4.2		0 to 4	-0.3 to 4.2	V		
		Full range	0 to 3.5		0 to 3.5					
V_{OH} High-level output voltage	$I_{OH} = -20\ \mu\text{A}$ $I_{OH} = -75\ \mu\text{A}$ $I_{OH} = -150\ \mu\text{A}$	25°C	4.98			4.98			V	
		25°C	4.9	4.94		4.9	4.94			
		Full range	4.8			4.8				
		25°C	4.8	4.88		4.8	4.88			
V_{OL} Low-level output voltage	$V_{IC} = 2.5\text{ V}$, $I_{OL} = 50\ \mu\text{A}$ $I_{OL} = 500\ \mu\text{A}$ $I_{OL} = 4\text{ mA}$	25°C	0.01			0.01			V	
		25°C	0.09	0.15		0.09	0.15			
		Full range	0.15			0.15				
		25°C	0.8	1		0.7	1			
		Full range	1.2			1.2				
		25°C	100	350		100	350			
AVD Large-signal differential voltage amplification	$V_{IC} = 2.5\text{ V}$, $V_O = 1\text{ V to }4\text{ V}$	$R_L = 100\text{ k}\Omega$ ‡	25°C	100			100			V/mV
			Full range	10			10			
		$R_L = 1\text{ M}\Omega$ ‡	25°C	1700			1700			
r_{id} Differential input resistance		25°C	10^{12}			10^{12}			Ω	
r_{ic} Common-mode input resistance		25°C	10^{12}			10^{12}			Ω	
c_{ic} Common-mode input capacitance	$f = 10\text{ kHz}$, $f = 10\text{ kHz}$	25°C	8			8			pF	
z_o Closed-loop output impedance	$f = 25\text{ kHz}$, $A_V = 10$	25°C	200			200			Ω	
CMRR Common-mode rejection ratio	$V_{IC} = 0\text{ to }2.7\text{ V}$, $R_S = 50\ \Omega$, $V_O = 2.5\text{ V}$	25°C	70	83		70	83	dB		
		Full range	70			70				
k_{SVR} Supply-voltage rejection ratio ($\Delta V_{DD}/\Delta V_{IO}$)	$V_{DD} = 4.4\text{ V to }16\text{ V}$, $V_{IC} = V_{DD}/2$, No load	25°C	80	95		80	95	dB		
		Full range	80			80				
I_{DD} Supply current	$V_O = 2.5\text{ V}$, No load	25°C	70	125		70	125	μA		
		Full range	150			150				

† Full range is -40°C to 125°C for Q suffix, -55°C to 125°C for M suffix.

‡ Referenced to 2.5 V

NOTE 4: Typical values are based on the input offset voltage shift observed through 500 hours of operating life test at $T_A = 150^\circ\text{C}$ extrapolated to $T_A = 25^\circ\text{C}$ using the Arrhenius equation and assuming an activation energy of 0.96 eV.



TLC225x, TLC225xA
Advanced LinCMOS™ RAIL-TO-RAIL
VERY LOW-POWER OPERATIONAL AMPLIFIERS

SLOS176D – FEBRUARY 1997 – REVISED MARCH 2001

operating characteristics at specified free-air temperature, $V_{DD} = 5\text{ V}$

PARAMETER	TEST CONDITIONS	T_A †	TLC2252Q TLC2252M			TLC2252AQ TLC2252AM			UNIT
			MIN	TYP	MAX	MIN	TYP	MAX	
SR	Slew rate at unity gain $V_O = 0.5\text{ V to }3.5\text{ V}$, $R_L = 100\text{ k}\Omega$ ‡, $C_L = 100\text{ pF}$ ‡	25°C	0.07	0.12		0.07	0.12		V/ μs
		Full range	0.05			0.05			
V_n	Equivalent input noise voltage $f = 10\text{ Hz}$ $f = 1\text{ kHz}$	25°C	36			36			nV/ $\sqrt{\text{Hz}}$
		25°C	19			19			
$V_{N(PP)}$	Peak-to-peak equivalent input noise voltage $f = 0.1\text{ Hz to }1\text{ Hz}$ $f = 0.1\text{ Hz to }10\text{ Hz}$	25°C	0.7			0.7			μV
		25°C	1.1			1.1			
I_n	Equivalent input noise current	25°C	0.6			0.6			fA/ $\sqrt{\text{Hz}}$
THD + N	Total harmonic distortion plus noise $V_O = 0.5\text{ V to }2.5\text{ V}$, $f = 10\text{ kHz}$, $R_L = 50\text{ k}\Omega$ ‡	$A_V = 1$	0.2%			0.2%			
		$A_V = 10$	1%			1%			
	Gain-bandwidth product $f = 50\text{ kHz}$, $C_L = 100\text{ pF}$ ‡	$R_L = 50\text{ k}\Omega$ ‡, 25°C	0.2			0.2			MHz
B_{OM}	Maximum output-swing bandwidth $V_{O(PP)} = 2\text{ V}$, $R_L = 50\text{ k}\Omega$ ‡, $A_V = 1$, $C_L = 100\text{ pF}$ ‡	25°C	30			30			kHz
ϕ_m	Phase margin at unity gain $R_L = 50\text{ k}\Omega$ ‡, $C_L = 100\text{ pF}$ ‡	25°C	63°			63°			
		25°C	15			15			dB

† Full range is – 40°C to 125°C for Q suffix, – 55°C to 125°C for M suffix.

‡ Referenced to 2.5 V

TLC225x, TLC225xA
Advanced LinCMOS™ RAIL-TO-RAIL
VERY LOW-POWER OPERATIONAL AMPLIFIERS

SLOS176D – FEBRUARY 1997 – REVISED MARCH 2001

electrical characteristics at specified free-air temperature, $V_{DD\pm} = \pm 5$ V (unless otherwise noted)

PARAMETER	TEST CONDITIONS	T_A †	TLC2252Q TLC2252M			TLC2252AQ TLC2252AM			UNIT
			MIN	TYP	MAX	MIN	TYP	MAX	
V_{IO} Input offset voltage	$V_{IC} = 0, V_O = 0, R_S = 50 \Omega$	25°C	200	1500		200	850	μV	
		Full range			1750		1000		
αV_{IO} Temperature coefficient of input offset voltage		25°C to 125°C	0.5			0.5			$\mu V/^\circ C$
Input offset voltage long-term drift (see Note 4)		25°C	0.003			0.003			$\mu V/mo$
I_{IO} Input offset current		25°C	0.5	60		0.5	60	pA	
		Full range			1000		1000		
I_{IB} Input bias current	25°C	1	60		1	60	pA		
	Full range			1000		1000			
V_{ICR} Common-mode input voltage range	$R_S = 50 \Omega, V_{IO} \leq 5 mV$	25°C	-5 to 4	-5.3 to 4.2		-5 to 4	-5.3 to 4.2	V	
		Full range	-5 to 3.5			-5 to 3.5			
V_{OM+} Maximum positive peak output voltage	$I_O = -20 \mu A$	25°C	4.98		4.98		V		
	$I_O = -100 \mu A$	25°C	4.9	4.93	4.9	4.93			
		Full range	4.7		4.7				
	$I_O = -200 \mu A$	25°C	4.8	4.86	4.8	4.86			
V_{OM-} Maximum negative peak output voltage	$V_{IC} = 0, I_O = 50 \mu A$	25°C	-4.99		-4.99		V		
	$V_{IC} = 0, I_O = 500 \mu A$	25°C	-4.85	-4.91	-4.85	-4.91			
		Full range	-4.85		-4.85				
	$V_{IC} = 0, I_O = 4 mA$	25°C	-4	-4.3	-4	-4.3			
		Full range	-3.8		-3.8				
A_{VD} Large-signal differential voltage amplification	$V_O = \pm 4 V$	$R_L = 100 k\Omega$	25°C	40	150	40	150	V/mV	
			Full range	10		10			
		$R_L = 1 M\Omega$	25°C	3000		3000			
r_{id} Differential input resistance		25°C	10^{12}		10^{12}		Ω		
r_{ic} Common-mode input resistance		25°C	10^{12}		10^{12}		Ω		
c_{ic} Common-mode input capacitance	$f = 10 kHz, P$ package	25°C	8		8		pF		
z_o Closed-loop output impedance	$f = 25 kHz, A_V = 10$	25°C	190		190		Ω		
CMRR Common-mode rejection ratio	$V_{IC} = -5 V$ to 2.7 V, $V_O = 0, R_S = 50 \Omega$	25°C	75	88	75	88	dB		
		Full range	75		75				
k_{SVR} Supply-voltage rejection ratio ($\Delta V_{DD\pm} / \Delta V_{IO}$)	$V_{DD} = \pm 2.2 V$ to $\pm 8 V, V_{IC} = 0, No load$	25°C	80	95	80	95	dB		
		Full range	80		80				
I_{DD} Supply current	$V_O = 2.5 V, No load$	25°C	80	125	80	125	μA		
		Full range	150		150				

† Full range is -40°C to 125°C for Q suffix, -55°C to 125°C for M suffix.

NOTE 4: Typical values are based on the input offset voltage shift observed through 500 hours of operating life test at $T_A = 150^\circ C$ extrapolated to $T_A = 25^\circ C$ using the Arrhenius equation and assuming an activation energy of 0.96 eV.



TLC225x, TLC225xA
Advanced LinCMOS™ RAIL-TO-RAIL
VERY LOW-POWER OPERATIONAL AMPLIFIERS

SLOS176D – FEBRUARY 1997 – REVISED MARCH 2001

operating characteristics at specified free-air temperature, $V_{DD\pm} = \pm 5\text{ V}$

PARAMETER	TEST CONDITIONS	T_A †	TLC2252Q TLC2252M			TLC2252AQ TLC2252AM			UNIT
			MIN	TYP	MAX	MIN	TYP	MAX	
SR	Slew rate at unity gain $V_O = \pm 2\text{ V}$, $C_L = 100\text{ pF}$, $R_L = 100\text{ k}\Omega$	25°C	0.07	0.12		0.07	0.12		$\text{V}/\mu\text{s}$
		Full range	0.05			0.05			
V_n	Equivalent input noise voltage	25°C		38			38		$\text{nV}/\sqrt{\text{Hz}}$
		25°C		19			19		
$V_{N(PP)}$	Peak-to-peak equivalent input noise voltage	25°C		0.8			0.8		μV
		25°C		1.1			1.1		
I_n	Equivalent input noise current	25°C		0.6			0.6	$\text{fA}/\sqrt{\text{Hz}}$	
THD + N	Total harmonic distortion plus noise $V_O = \pm 2.3\text{ V}$, $R_L = 50\text{ k}\Omega$, $f = 10\text{ kHz}$	25°C		0.2%			0.2%		
		25°C		1%			1%		
	Gain-bandwidth product $f = 10\text{ kHz}$, $C_L = 100\text{ pF}$, $R_L = 50\text{ k}\Omega$	25°C		0.21			0.21	MHz	
BOM	Maximum output-swing bandwidth $V_{O(PP)} = 4.6\text{ V}$, $R_L = 50\text{ k}\Omega$, $A_V = 1$, $C_L = 100\text{ pF}$	25°C		14			14	kHz	
ϕ_m	Phase margin at unity gain $R_L = 50\text{ k}\Omega$, $C_L = 100\text{ pF}$	25°C		63°			63°		
		25°C		15			15	dB	

† Full range is – 40°C to 125°C for Q suffix, – 55°C to 125°C for M suffix.

TLC225x, TLC225xA Advanced LinCMOS™ RAIL-TO-RAIL VERY LOW-POWER OPERATIONAL AMPLIFIERS

SLOS176D – FEBRUARY 1997 – REVISED MARCH 2001

electrical characteristics at specified free-air temperature, $V_{DD} = 5\text{ V}$ (unless otherwise noted)

PARAMETER	TEST CONDITIONS	T_A †	TLC2254Q TLC2254M			TLC2254AQ TLC2254AM			UNIT
			MIN	TYP	MAX	MIN	TYP	MAX	
V_{IO} Input offset voltage		25°C	200	1500		200	850	μV	
		Full range		1750		1000			
α_{VIO} Temperature coefficient of input offset voltage		25°C to 125°C	0.5			0.5			$\mu\text{V}/^\circ\text{C}$
Input offset voltage long-term drift (see Note 4)	$V_{DD\pm} = \pm 2.5\text{ V}$, $V_{IC} = 0$, $V_O = 0$, $R_S = 50\ \Omega$	25°C	0.003			0.003			$\mu\text{V}/\text{mo}$
I_{IO} Input offset current		25°C	0.5	60		0.5	60	pA	
		125°C	1000			1000			
I_{IB} Input bias current		25°C	1	60		1	60	pA	
	125°C	1000			1000				
V_{ICR} Common-mode input voltage range	$R_S = 50\ \Omega$, $ V_{IO} \leq 5\text{ mV}$	25°C	0 to 4	-0.3 to 4.2		0 to 4	-0.3 to 4.2	V	
		Full range	0 to 3.5		0 to 3.5				
V_{OH} High-level output voltage	$I_{OH} = -20\ \mu\text{A}$	25°C	4.98			4.98			V
	$I_{OH} = -75\ \mu\text{A}$	25°C	4.9	4.94		4.9	4.94		
	Full range	4.8			4.8				
	$I_{OH} = -150\ \mu\text{A}$	25°C	4.8	4.88		4.8	4.88		
V_{OL} Low-level output voltage	$V_{IC} = 2.5\text{ V}$, $I_{OL} = 50\ \mu\text{A}$	25°C	0.01			0.01			V
	$V_{IC} = 2.5\text{ V}$, $I_{OL} = 500\ \mu\text{A}$	25°C	0.09	0.15		0.09	0.15		
		Full range	0.15			0.15			
	$V_{IC} = 2.5\text{ V}$, $I_{OL} = 4\text{ mA}$	25°C	0.8	1		0.7	1		
		Full range	1.2			1.2			
	A_{VD} Large-signal differential voltage amplification	$V_{IC} = 2.5\text{ V}$, $V_O = 1\text{ V to }4\text{ V}$	$R_L = 100\text{ k}\Omega$ ‡	25°C	100	350		100	
Full range			10			10			
$R_L = 1\text{ M}\Omega$ ‡			25°C	1700			1700		
$r_{i(d)}$ Differential input resistance		25°C	1012			1012			Ω
$r_{i(c)}$ Common-mode input resistance		25°C	1012			1012			Ω
$C_{i(c)}$ Common-mode input capacitance	$f = 10\text{ kHz}$, N package	25°C	8			8			pF
z_o Closed-loop output impedance	$f = 25\text{ kHz}$, $A_V = 10$	25°C	200			200			Ω
CMRR Common-mode rejection ratio	$V_{IC} = 0\text{ to }2.7\text{ V}$, $V_O = 2.5\text{ V}$, $R_S = 50\ \Omega$	25°C	70	83		70	83	dB	
		Full range	70			70			
k_{SVR} Supply-voltage rejection ratio ($\Delta V_{DD}/\Delta V_{IO}$)	$V_{DD} = 4.4\text{ V to }16\text{ V}$, $V_{IC} = V_{DD}/2$, No load	25°C	80	95		80	95	dB	
		Full range	80			80			
I_{DD} Supply current (four amplifiers)	$V_O = 2.5\text{ V}$, No load	25°C	140	250		140	250	μA	
		Full range	300			300			

† Full range is -40°C to 125°C for Q suffix, -55°C to 125°C for M suffix.

‡ Referenced to 2.5 V

NOTE 4: Typical values are based on the input offset voltage shift observed through 500 hours of operating life test at $T_A = 150^\circ\text{C}$ extrapolated to $T_A = 25^\circ\text{C}$ using the Arrhenius equation and assuming an activation energy of 0.96 eV.



TLC225x, TLC225xA
Advanced LinCMOS™ RAIL-TO-RAIL
VERY LOW-POWER OPERATIONAL AMPLIFIERS

SLOS176D – FEBRUARY 1997 – REVISED MARCH 2001

operating characteristics at specified free-air temperature, $V_{DD} = 5\text{ V}$

PARAMETER	TEST CONDITIONS	T_A †	TLC2254Q TLC2254M			TLC2254AQ TLC2254AM			UNIT
			MIN	TYP	MAX	MIN	TYP	MAX	
SR	Slew rate at unity gain $V_O = 0.5\text{ V to }3.5\text{ V}$, $R_L = 100\text{ k}\Omega$ ‡, $C_L = 100\text{ pF}$ ‡	25°C	0.07	0.12		0.07	0.12		V/ μs
		Full range	0.05			0.05			
V_n	Equivalent input noise voltage	f = 10 Hz	36			36			nV/ $\sqrt{\text{Hz}}$
		f = 1 kHz	19			19			
$V_{N(PP)}$	Peak-to-peak equivalent input noise voltage	f = 0.1 Hz to 1 Hz	0.7			0.7			μV
		f = 0.1 Hz to 10 Hz	1.1			1.1			
I_n	Equivalent input noise current	25°C	0.6			0.6			fA/ $\sqrt{\text{Hz}}$
THD + N	Total harmonic distortion plus noise $V_O = 0.5\text{ V to }2.5\text{ V}$, f = 20 kHz, $R_L = 50\text{ k}\Omega$ ‡	$A_V = 1$	0.2%			0.2%			
		$A_V = 10$	1%			1%			
	Gain-bandwidth product f = 50 kHz, $C_L = 100\text{ pF}$ ‡	$R_L = 50\text{ k}\Omega$ ‡, 25°C	0.2			0.2			MHz
B_{OM}	Maximum output-swing bandwidth $V_{O(PP)} = 2\text{ V}$, $R_L = 50\text{ k}\Omega$ ‡, $A_V = 1$, $C_L = 100\text{ pF}$ ‡	25°C	30			30			kHz
ϕ_m	Phase margin at unity gain $R_L = 50\text{ k}\Omega$ ‡, $C_L = 100\text{ pF}$ ‡	25°C	63°			63°			
		25°C	15			15			dB

† Full range is – 40°C to 125°C for Q suffix, – 55°C to 125°C for M suffix.

‡ Referenced to 2.5 V

TLC225x, TLC225xA
Advanced LinCMOS™ RAIL-TO-RAIL
VERY LOW-POWER OPERATIONAL AMPLIFIERS

SLOS176D – FEBRUARY 1997 – REVISED MARCH 2001

electrical characteristics at specified free-air temperature, $V_{DD\pm} = \pm 5$ V (unless otherwise noted)

PARAMETER	TEST CONDITIONS	T_A †	TLC2254Q TLC2254M			TLC2254AQ TLC2254AM			UNIT
			MIN	TYP	MAX	MIN	TYP	MAX	
V_{IO} Input offset voltage	$V_{IC} = 0, V_O = 0, R_S = 50 \Omega$	25°C	200	1500		200	850	μV	
		Full range			1750		1000		
αV_{IO} Temperature coefficient of input offset voltage		25°C to 125°C	0.5			0.5		$\mu V/^\circ C$	
Input offset voltage long-term drift (see Note 4)		25°C	0.003			0.003		$\mu V/mo$	
I_{IO} Input offset current		25°C	0.5	60		0.5	60	pA	
		125°C			1000		1000		
I_{IB} Input bias current	25°C	1	60		1	60	pA		
	125°C			1000		1000			
V_{ICR} Common-mode input voltage range	$R_S = 50 \Omega, V_{IO} \leq 5 mV$	25°C	-5 to 4	-5.3 to 4.2		-5 to 4	-5.3 to 4.2	V	
		Full range	-5 to 3.5			-5 to 3.5			
V_{OM+} Maximum positive peak output voltage	$I_O = -20 \mu A$	25°C	4.98			4.98	V		
	$I_O = -100 \mu A$	25°C	4.9	4.93		4.9		4.93	
		Full range	4.7			4.7			
V_{OM-} Maximum negative peak output voltage	$V_{IC} = 0, I_O = 50 \mu A$	25°C	-4.99			-4.99	V		
	$V_{IC} = 0, I_O = 500 \mu A$	25°C	-4.85	-4.91		-4.85		-4.91	
		Full range	-4.85			-4.85			
	$V_{IC} = 0, I_O = 4 mA$	25°C	-4	-4.3		-4		-4.3	
		Full range	-3.8			-3.8			
A_{VD} Large-signal differential voltage amplification	$V_O = \pm 4 V$	$R_L = 100 k\Omega$	25°C	40	150		40	150	V/mV
			Full range	10			10		
		$R_L = 1 M\Omega$	25°C	3000			3000		
$r_{i(d)}$ Differential input resistance		25°C	1012			1012	Ω		
$r_{i(c)}$ Common-mode input resistance		25°C	1012			1012	Ω		
$C_{i(c)}$ Common-mode input capacitance	$f = 10 kHz, N$ package	25°C	8			8	pF		
Z_o Closed-loop output impedance	$f = 25 kHz, A_V = 10$	25°C	190			190	Ω		
CMRR Common-mode rejection ratio	$V_{IC} = -5 V$ to 2.7 V, $V_O = 0, R_S = 50 \Omega$	25°C	75	88		75	88	dB	
		Full range	75			75			
k_{SVR} Supply-voltage rejection ratio ($\Delta V_{DD\pm} / \Delta V_{IO}$)	$V_{DD\pm} = \pm 2.2 V$ to $\pm 8 V, V_{IC} = V_{DD}/2, No load$	25°C	80	95		80	95	dB	
		Full range	80			80			
I_{DD} Supply current (four amplifiers)	$V_O = 0, No load$	25°C	160	250		160	250	μA	
		Full range			300		300		

† Full range is -40°C to 125°C for Q suffix, -55°C to 125°C for M suffix.

NOTE 4: Typical values are based on the input offset voltage shift observed through 500 hours of operating life test at $T_A = 150^\circ C$ extrapolated to $T_A = 25^\circ C$ using the Arrhenius equation and assuming an activation energy of 0.96 eV.



TLC225x, TLC225xA
Advanced LinCMOS™ RAIL-TO-RAIL
VERY LOW-POWER OPERATIONAL AMPLIFIERS

SLOS176D – FEBRUARY 1997 – REVISED MARCH 2001

operating characteristics at specified free-air temperature, $V_{DD\pm} = \pm 5\text{ V}$

PARAMETER	TEST CONDITIONS		T_A †	TLC2254Q TLC2254M			TLC2254AQ TLC2254AM			UNIT
				MIN	TYP	MAX	MIN	TYP	MAX	
SR Slew rate at unity gain	$V_O = \pm 2\text{ V}$, $C_L = 100\text{ pF}$	$R_L = 100\text{ k}\Omega$,	25°C	0.07	0.12		0.07	0.12		V/ μs
			Full range	0.05			0.05			
V_n Equivalent input noise voltage	$f = 10\text{ Hz}$		25°C	38			38			nV/ $\sqrt{\text{Hz}}$
	$f = 1\text{ kHz}$		25°C	19			19			
$V_{N(PP)}$ Peak-to-peak equivalent input noise voltage	$f = 0.1\text{ Hz to }1\text{ Hz}$		25°C	0.8			0.8			μV
	$f = 0.1\text{ Hz to }10\text{ Hz}$		25°C	1.1			1.1			
I_n Equivalent input noise current			25°C	0.6			0.6			fA/ $\sqrt{\text{Hz}}$
THD + N Total harmonic distortion plus noise	$V_O = \pm 2.3\text{ V}$, $R_L = 50\text{ k}\Omega$, $f = 20\text{ kHz}$	$A_V = 1$	25°C	0.2%			0.2%			
		$A_V = 10$		1%			1%			
Gain-bandwidth product	$f = 10\text{ kHz}$, $C_L = 100\text{ pF}$	$R_L = 50\text{ k}\Omega$,	25°C	0.21			0.21			MHz
B_{OM} Maximum output-swing bandwidth	$V_{O(PP)} = 4.6\text{ V}$, $R_L = 50\text{ k}\Omega$,	$A_V = 1$, $C_L = 100\text{ pF}$	25°C	14			14			kHz
ϕ_m Phase margin at unity gain	$R_L = 50\text{ k}\Omega$,	$C_L = 100\text{ pF}$	25°C	63°			63°			
			Gain margin	25°C	15			15		

† Full range is – 40°C to 125°C for Q suffix, – 55°C to 125°C for M suffix.

TLC225x, TLC225xA
Advanced LinCMOS™ RAIL-TO-RAIL
VERY LOW-POWER OPERATIONAL AMPLIFIERS

SLOS176D – FEBRUARY 1997 – REVISED MARCH 2001

TYPICAL CHARACTERISTICS

Table of Graphs

		FIGURE	
V_{IO}	Input offset voltage	Distribution vs Common-mode input voltage	2 – 5 6, 7
αV_{IO}	Input offset voltage temperature coefficient	Distribution	8 – 11
I_{IB}/I_{IO}	Input bias and input offset currents	vs Free-air temperature	12
V_I	Input voltage range	vs Supply voltage vs Free-air temperature	13 14
V_{OH}	High-level output voltage	vs High-level output current	15
V_{OL}	Low-level output voltage	vs Low-level output current	16, 17
V_{OM+}	Maximum positive peak output voltage	vs Output current	18
V_{OM-}	Maximum negative peak output voltage	vs Output current	19
$V_{O(PP)}$	Maximum peak-to-peak output voltage	vs Frequency	20
I_{OS}	Short-circuit output current	vs Supply voltage vs Free-air temperature	21 22
V_O	Output voltage	vs Differential input voltage	23, 24
	Differential gain	vs Load resistance	25
A_{VD}	Large-signal differential voltage amplification	vs Frequency vs Free-air temperature	26, 27 28, 29
z_o	Output impedance	vs Frequency	30, 31
CMRR	Common-mode rejection ratio	vs Frequency vs Free-air temperature	32 33
k_{SVR}	Supply-voltage rejection ratio	vs Frequency vs Free-air temperature	34, 35 36
I_{DD}	Supply current	vs Supply voltage vs Free-air temperature	37 38
SR	Slew rate	vs Load capacitance vs Free-air temperature	39 40
V_O	Inverting large-signal pulse response		41, 42
V_O	Voltage-follower large-signal pulse response		43, 44
V_O	Inverting small-signal pulse response		45, 46
V_O	Voltage-follower small-signal pulse response		47, 48
V_n	Equivalent input noise voltage	vs Frequency	49, 50
	Noise voltage (referred to input)	Over a 10-second period	51
	Integrated noise voltage	vs Frequency	52
THD + N	Total harmonic distortion plus noise	vs Frequency	53
	Gain-bandwidth product	vs Free-air temperature vs Supply voltage	54 55
ϕ_m	Phase margin	vs Frequency vs Load capacitance	26, 27 56
A_m	Gain margin	vs Load capacitance	57
B_1	Unity-gain bandwidth	vs Load capacitance	58
	Overestimation of phase margin	vs Load capacitance	59



TYPICAL CHARACTERISTICS

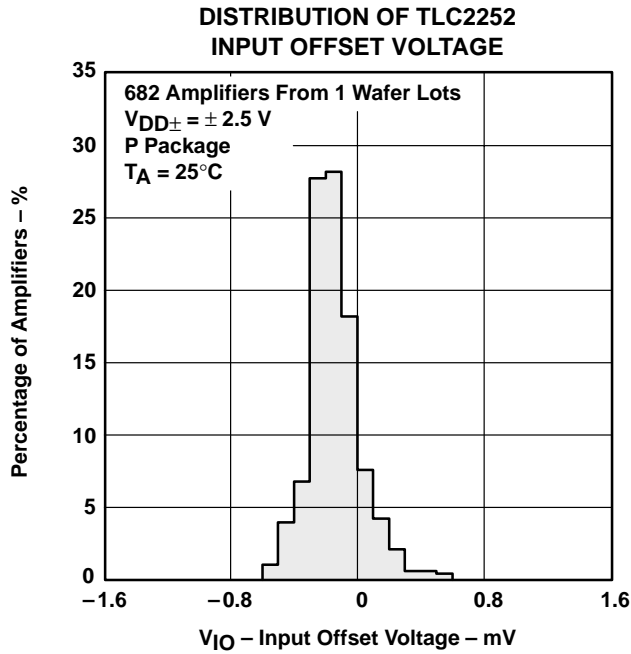

Figure 2

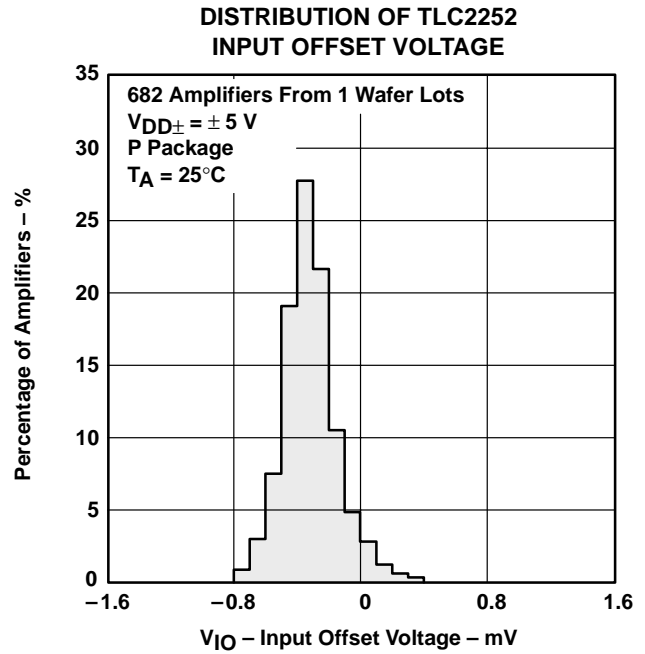

Figure 3

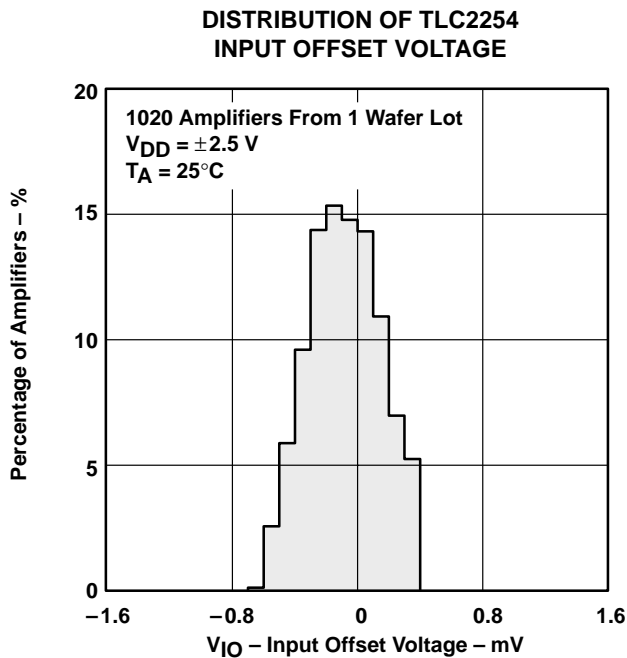

Figure 4

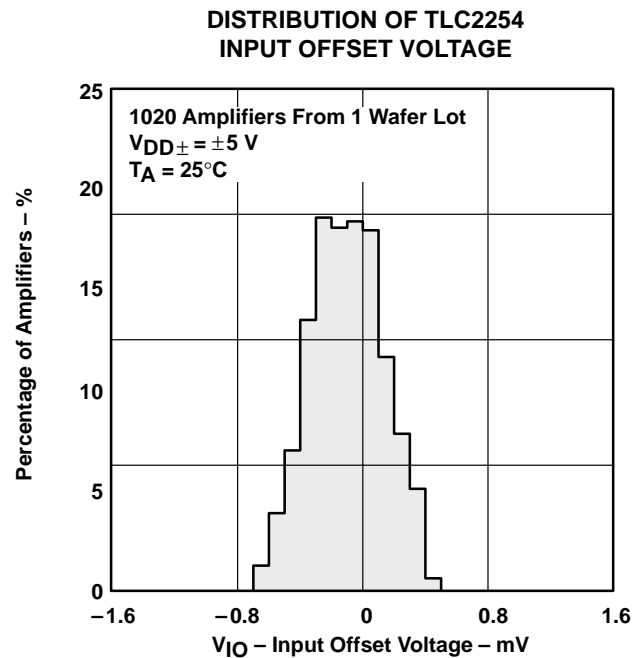

Figure 5

TLC225x, TLC225xA
Advanced LinCMOS™ RAIL-TO-RAIL
VERY LOW-POWER OPERATIONAL AMPLIFIERS

SLOS176D – FEBRUARY 1997 – REVISED MARCH 2001

TYPICAL CHARACTERISTICS

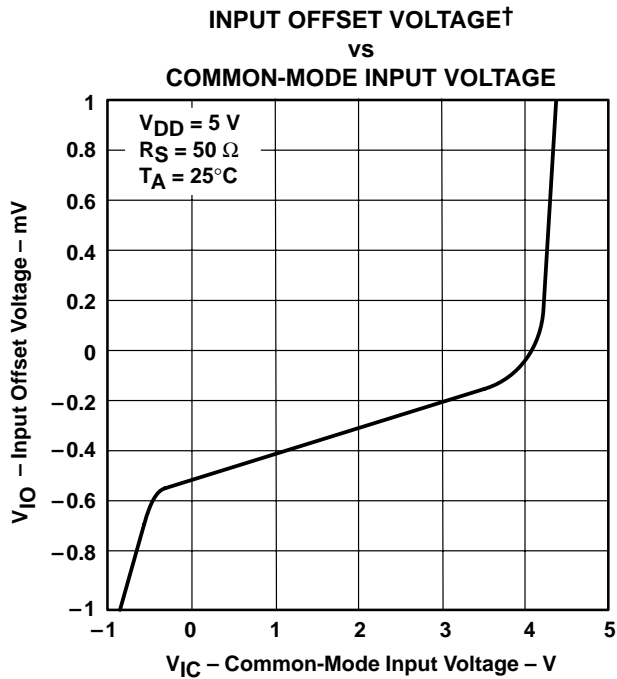

Figure 6

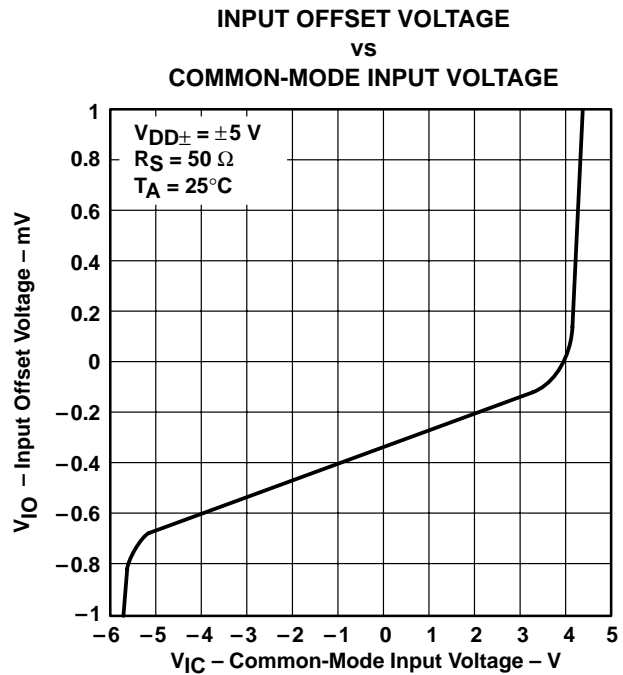

Figure 7

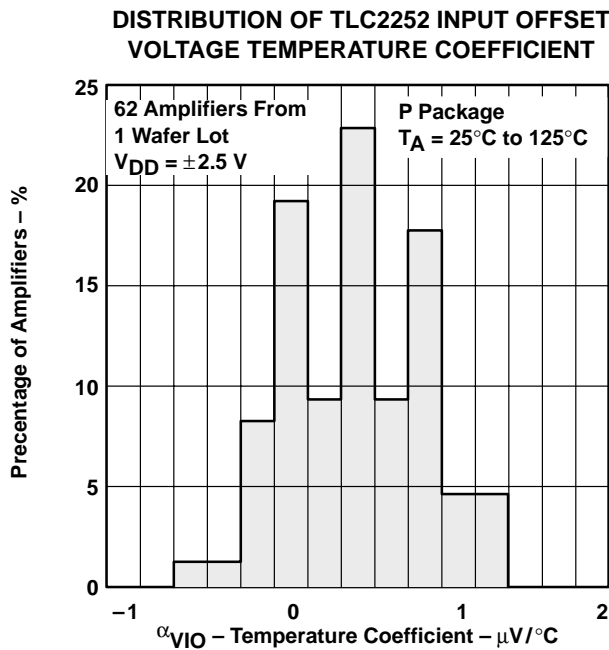

Figure 8

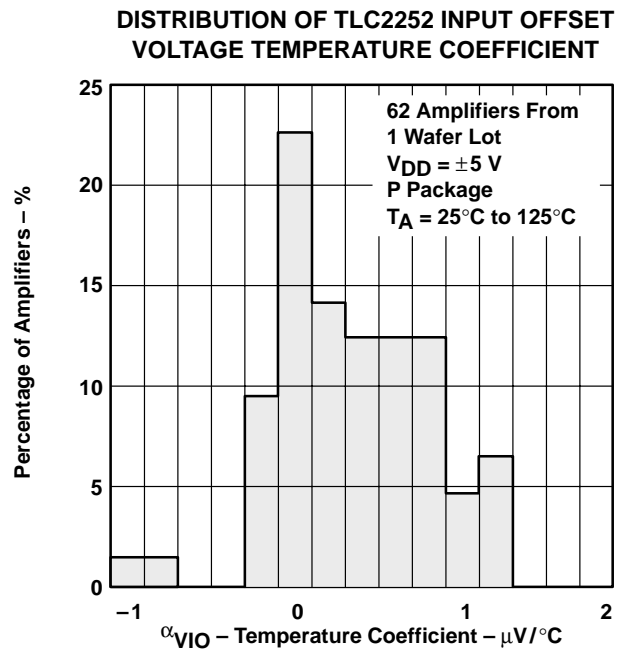

Figure 9

† For curves where $V_{DD} = 5\text{ V}$, all loads are referenced to 2.5 V.

TYPICAL CHARACTERISTICS

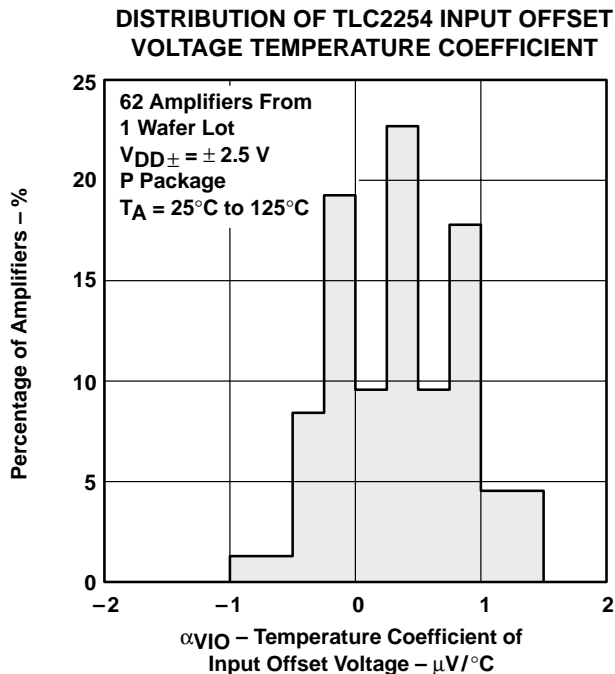

Figure 10

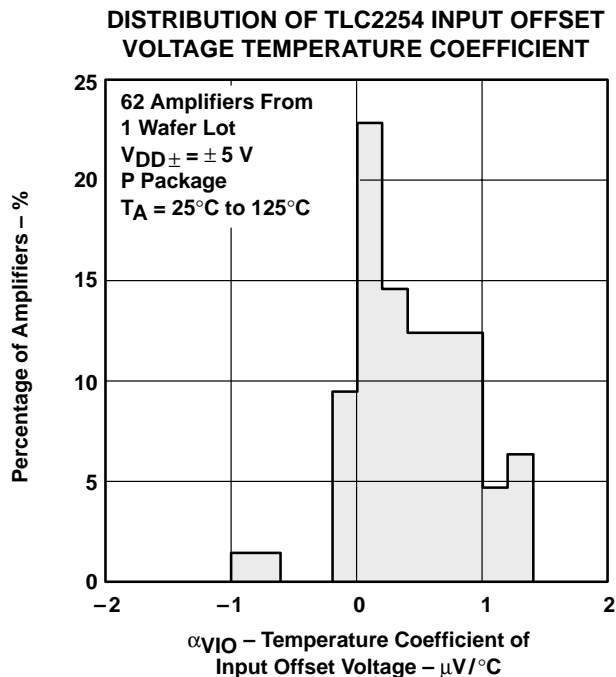

Figure 11

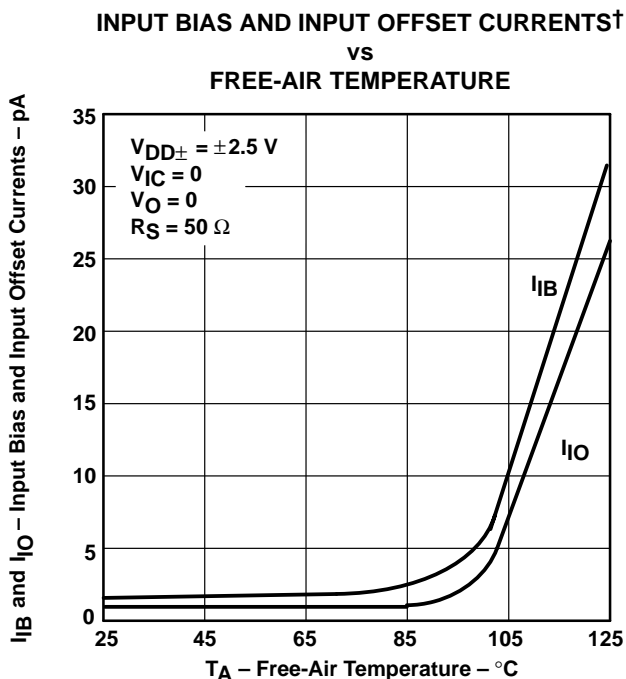

Figure 12

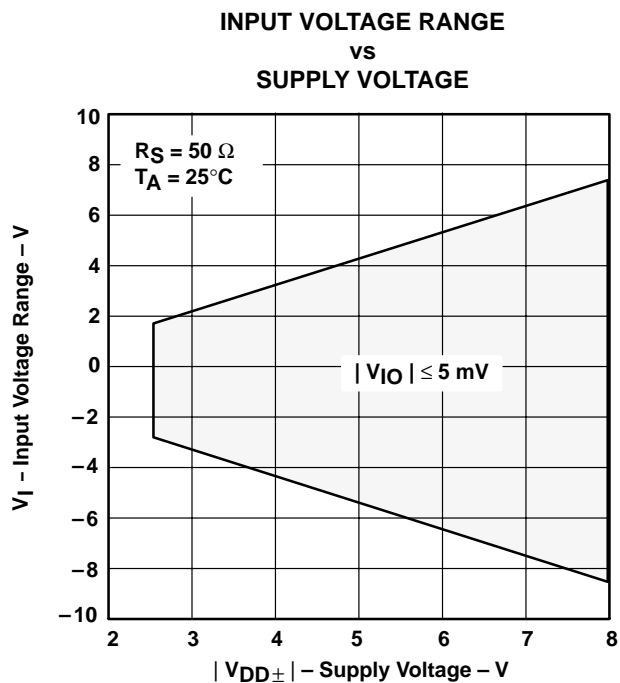

Figure 13

† Data at high and low temperatures are applicable only within the rated operating free-air temperature ranges of the various devices.

TYPICAL CHARACTERISTICS

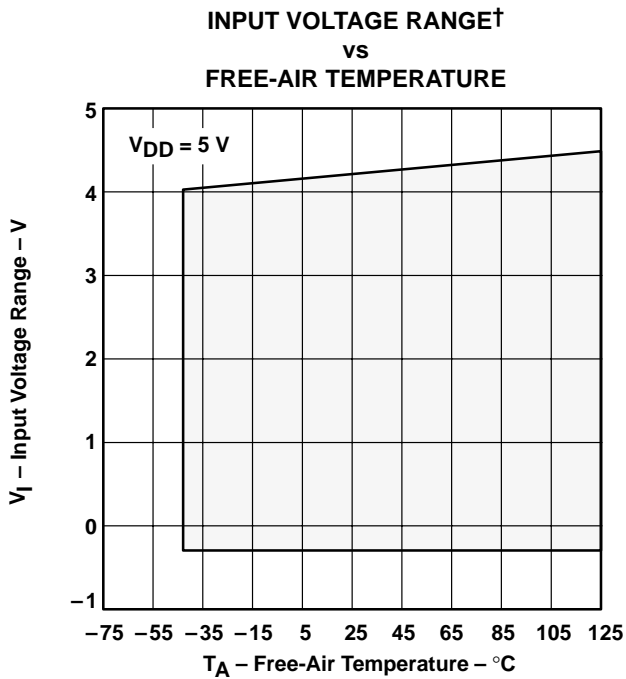

Figure 14

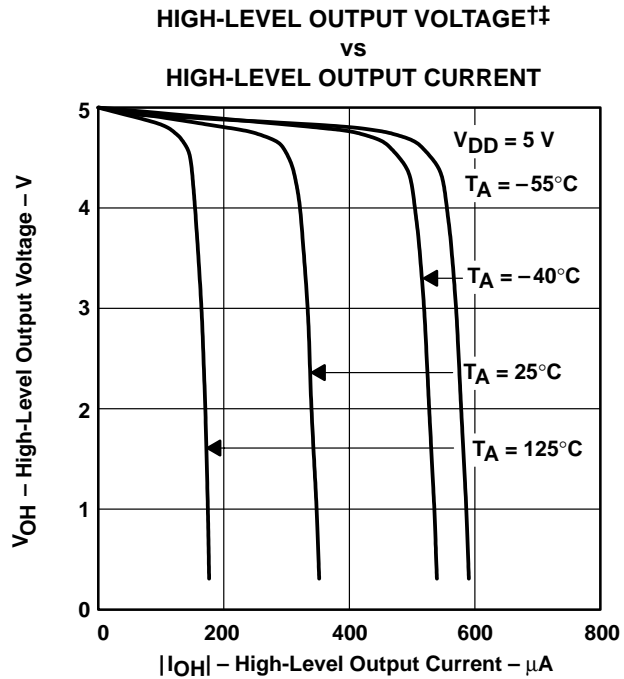

Figure 15

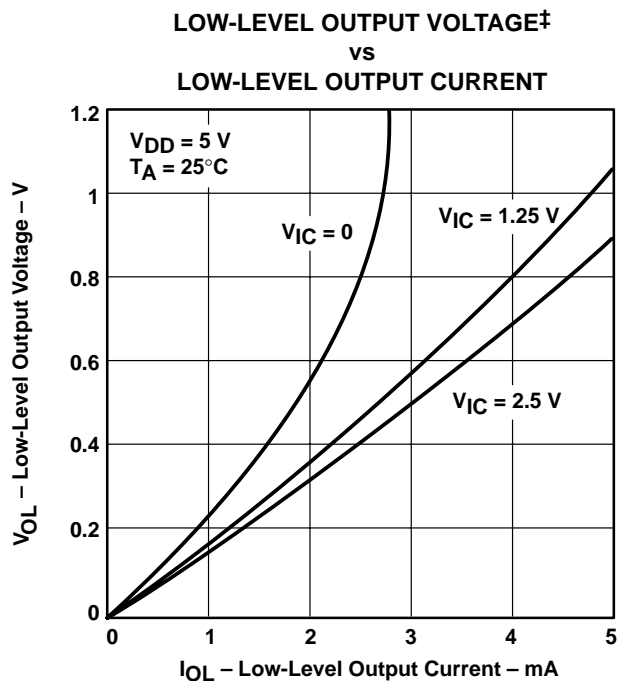

Figure 16

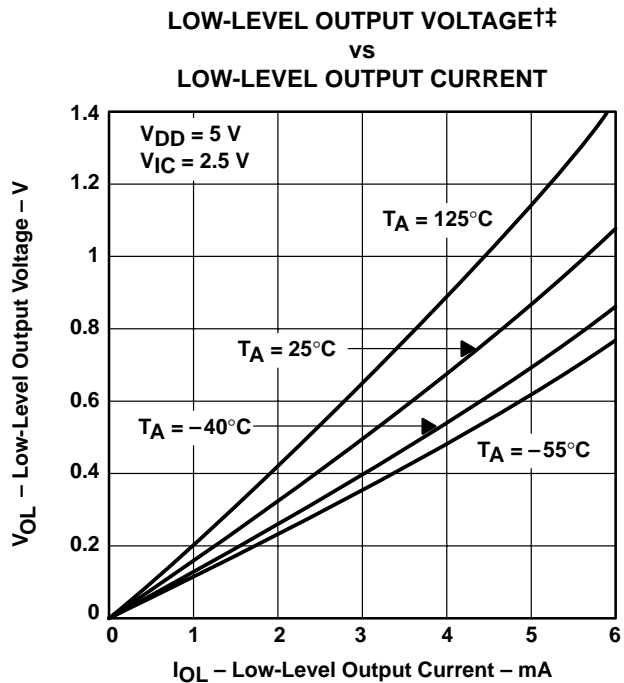

Figure 17

† Data at high and low temperatures are applicable only within the rated operating free-air temperature ranges of the various devices.
 ‡ For curves where $V_{DD} = 5\text{ V}$, all loads are referenced to 2.5 V.

TYPICAL CHARACTERISTICS

MAXIMUM POSITIVE PEAK OUTPUT VOLTAGE†
 vs
 OUTPUT CURRENT

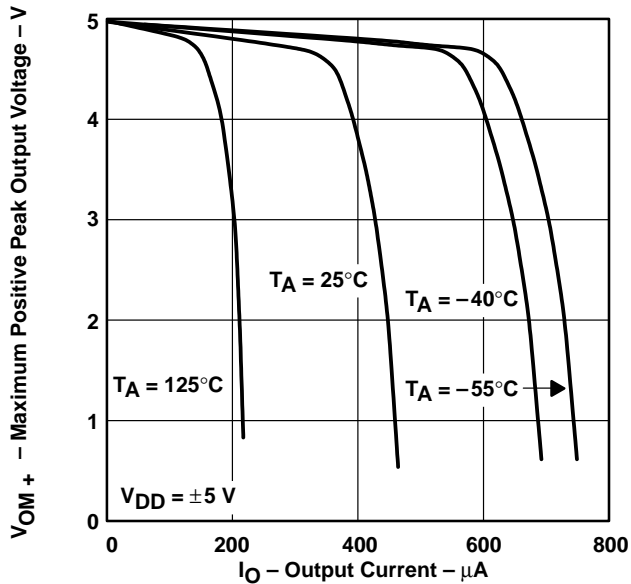

Figure 18

MAXIMUM NEGATIVE PEAK OUTPUT VOLTAGE†
 vs
 OUTPUT CURRENT

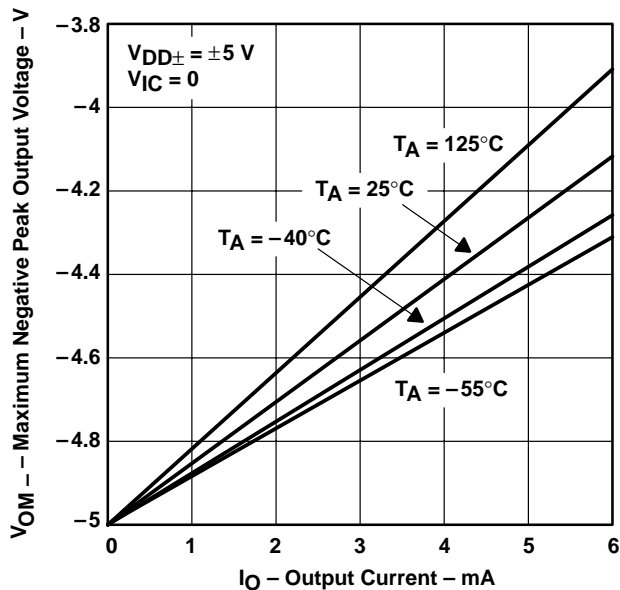

Figure 19

MAXIMUM PEAK-TO-PEAK OUTPUT VOLTAGE‡
 vs
 FREQUENCY

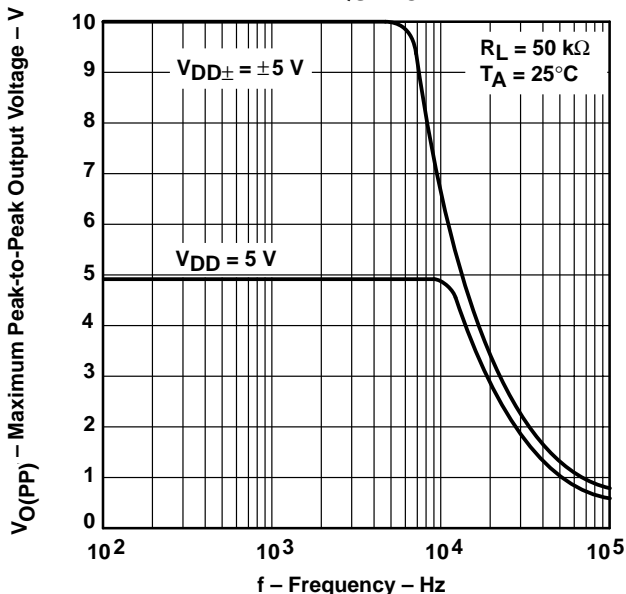

Figure 20

SHORT-CIRCUIT OUTPUT CURRENT
 vs
 SUPPLY VOLTAGE

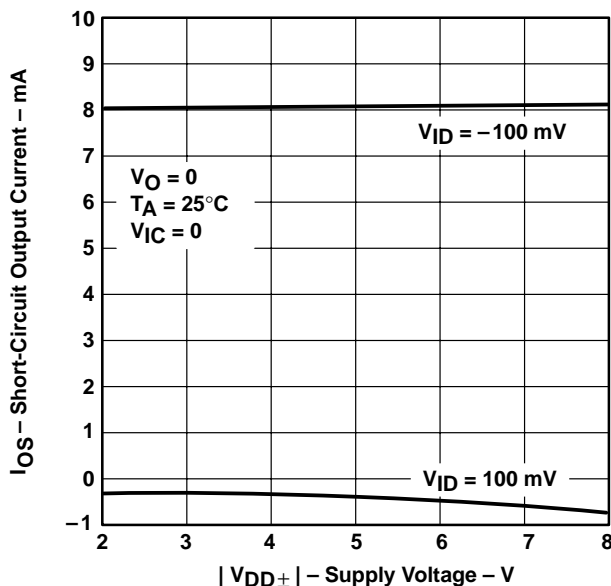

Figure 21

† Data at high and low temperatures are applicable only within the rated operating free-air temperature ranges of the various devices.

‡ For curves where $V_{DD} = 5\text{ V}$, all loads are referenced to 2.5 V .

TYPICAL CHARACTERISTICS

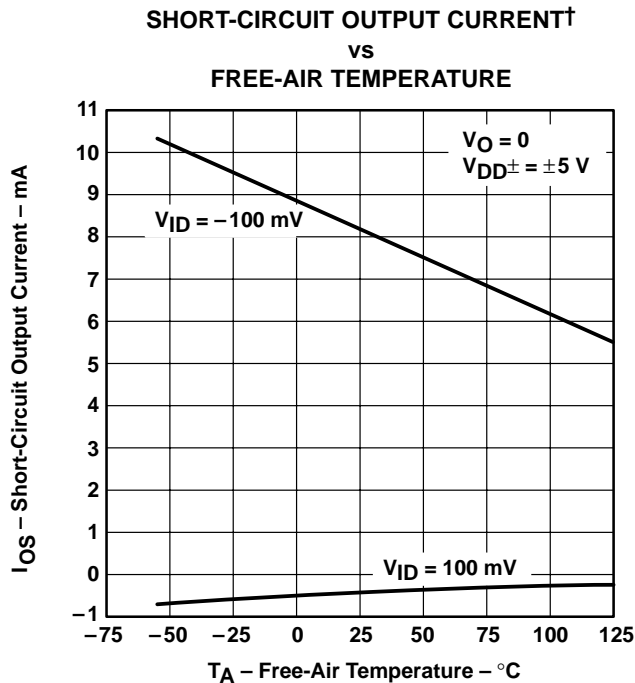

Figure 22

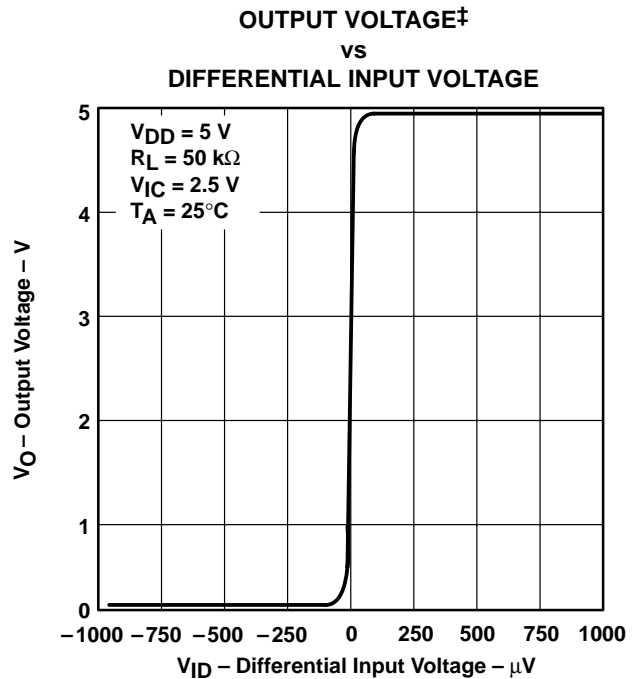

Figure 23

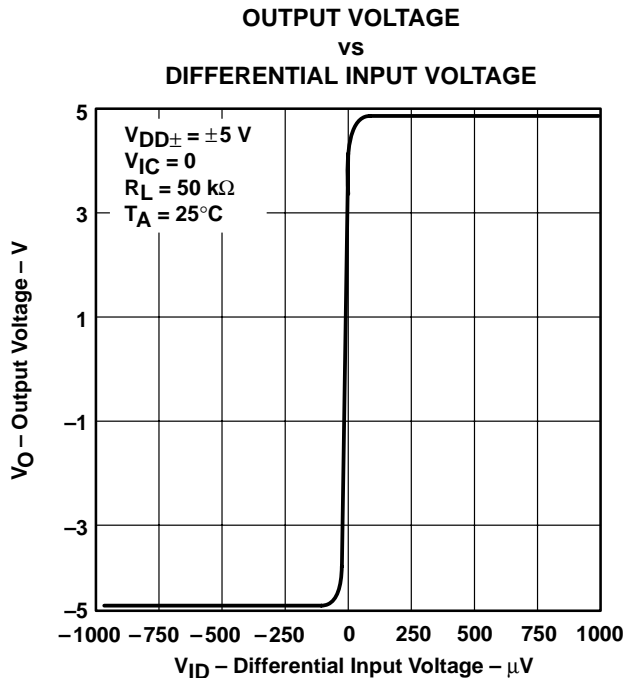

Figure 24

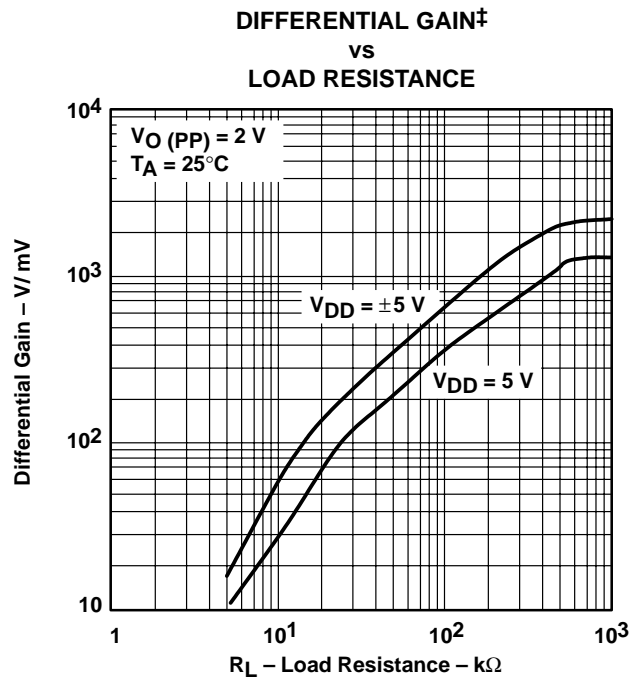

Figure 25

† Data at high and low temperatures are applicable only within the rated operating free-air temperature ranges of the various devices.

‡ For curves where $V_{DD} = 5 V$, all loads are referenced to 2.5 V.

TYPICAL CHARACTERISTICS

LARGE-SIGNAL DIFFERENTIAL VOLTAGE
 AMPLIFICATION AND PHASE MARGIN†
 VS
 FREQUENCY

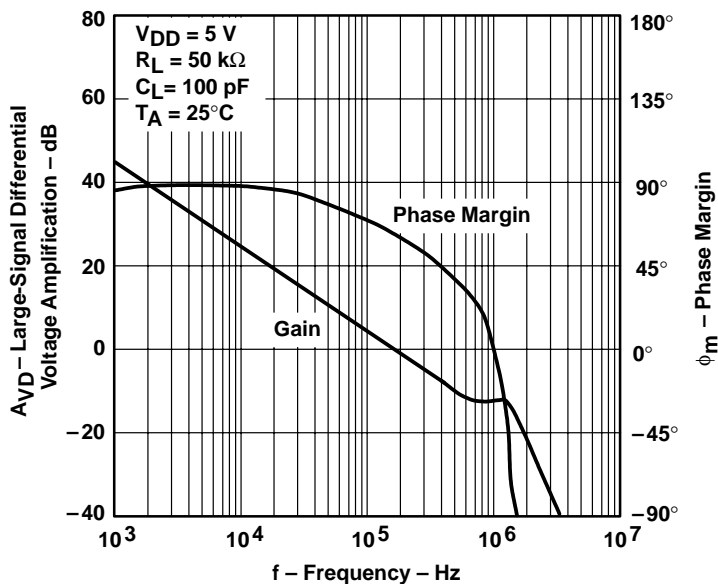

Figure 26

LARGE-SIGNAL DIFFERENTIAL VOLTAGE
 AMPLIFICATION AND PHASE MARGIN
 VS
 FREQUENCY

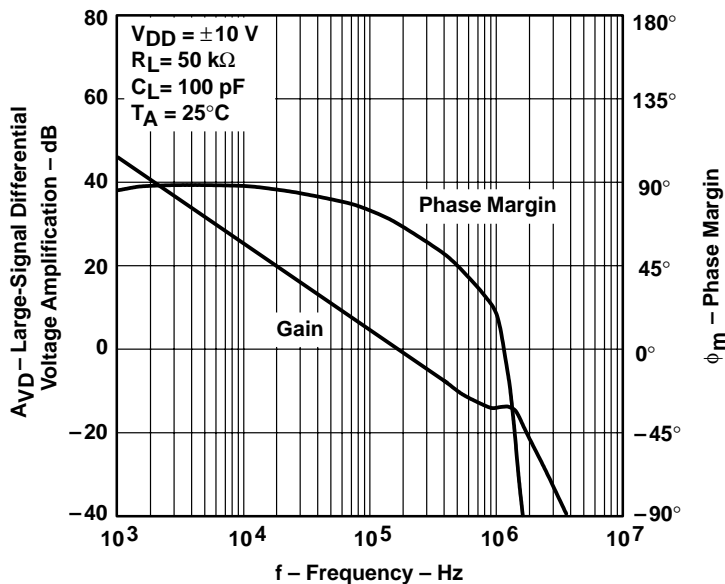

Figure 27

† For curves where V_{DD} = 5 V, all loads are referenced to 2.5 V.

TLC225x, TLC225xA
Advanced LinCMOS™ RAIL-TO-RAIL
VERY LOW-POWER OPERATIONAL AMPLIFIERS

SLOS176D – FEBRUARY 1997 – REVISED MARCH 2001

TYPICAL CHARACTERISTICS

LARGE-SIGNAL DIFFERENTIAL VOLTAGE AMPLIFICATION†‡
vs
FREE-AIR TEMPERATURE

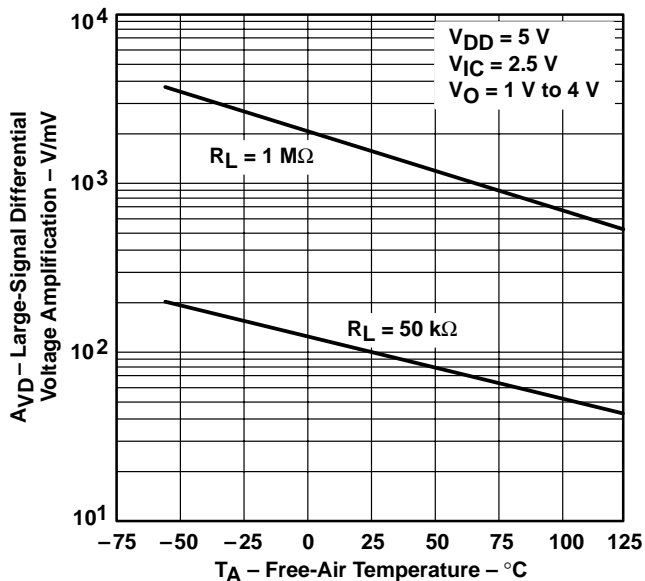

Figure 28

LARGE-SIGNAL DIFFERENTIAL VOLTAGE AMPLIFICATION†
vs
FREE-AIR TEMPERATURE

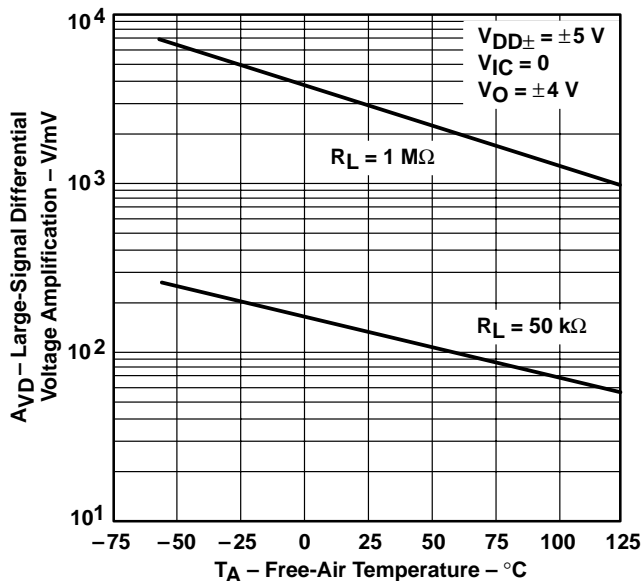

Figure 29

OUTPUT IMPEDANCE‡
vs
FREQUENCY

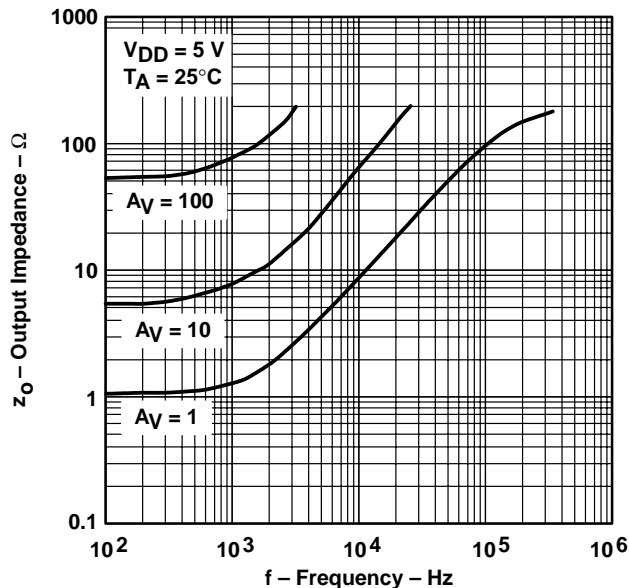

Figure 30

OUTPUT IMPEDANCE
vs
FREQUENCY

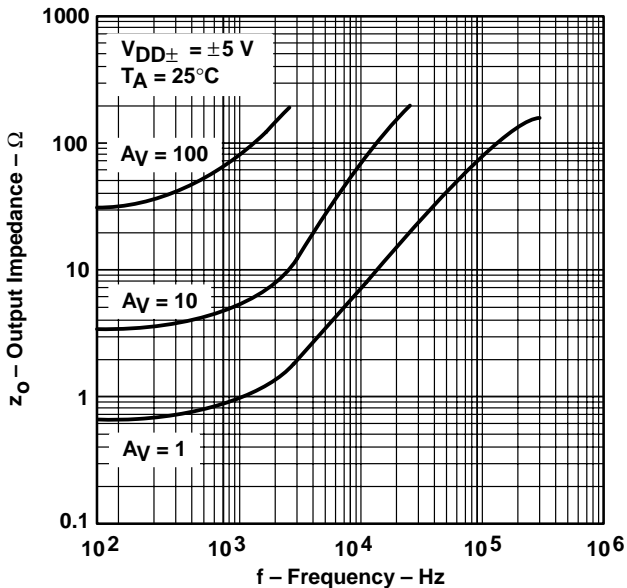

Figure 31

† Data at high and low temperatures are applicable only within the rated operating free-air temperature ranges of the various devices.

‡ For curves where $V_{DD} = 5\text{ V}$, all loads are referenced to 2.5 V.



TYPICAL CHARACTERISTICS

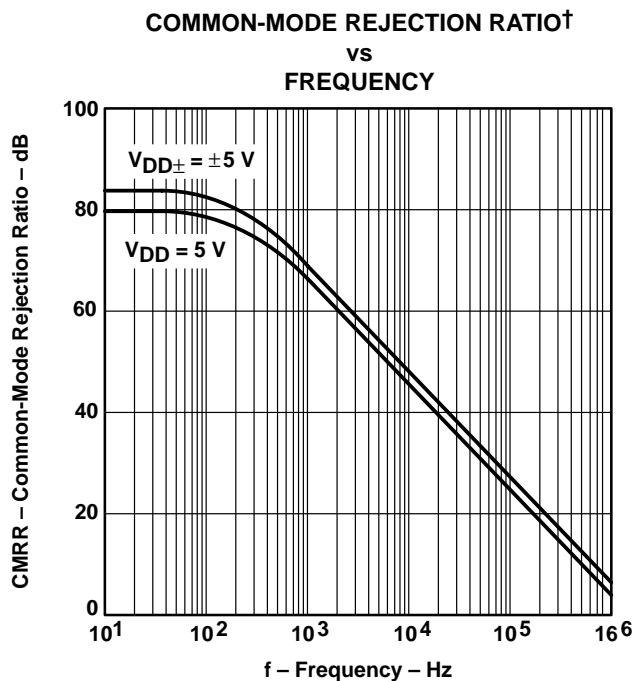

Figure 32

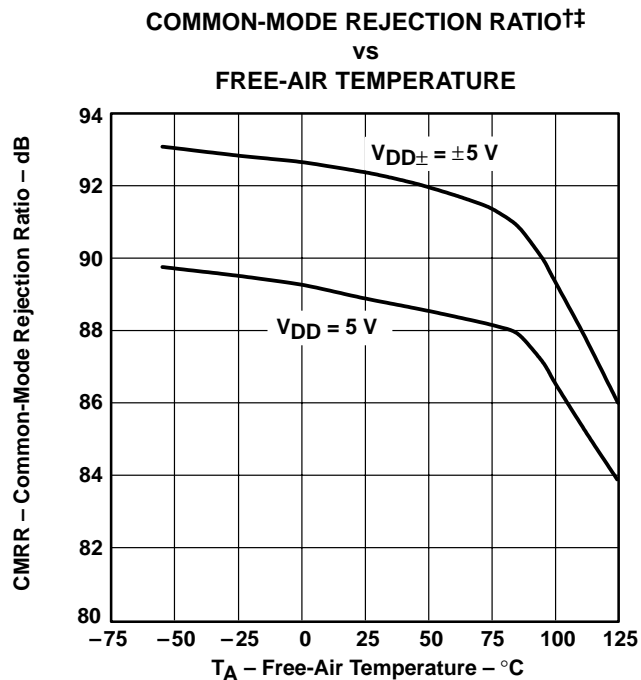

Figure 33

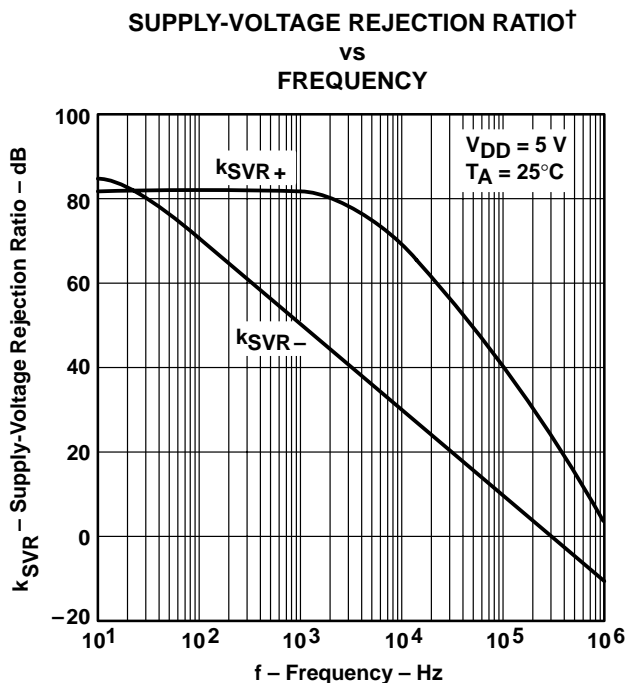

Figure 34

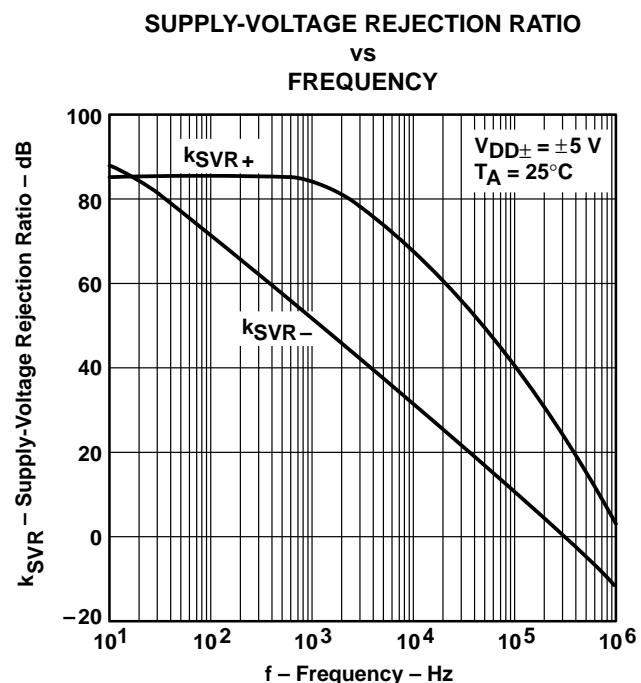

Figure 35

† For curves where $V_{DD} = 5\text{ V}$, all loads are referenced to 2.5 V.

†† Data at high and low temperatures are applicable only within the rated operating free-air temperature ranges of the various devices.

TYPICAL CHARACTERISTICS

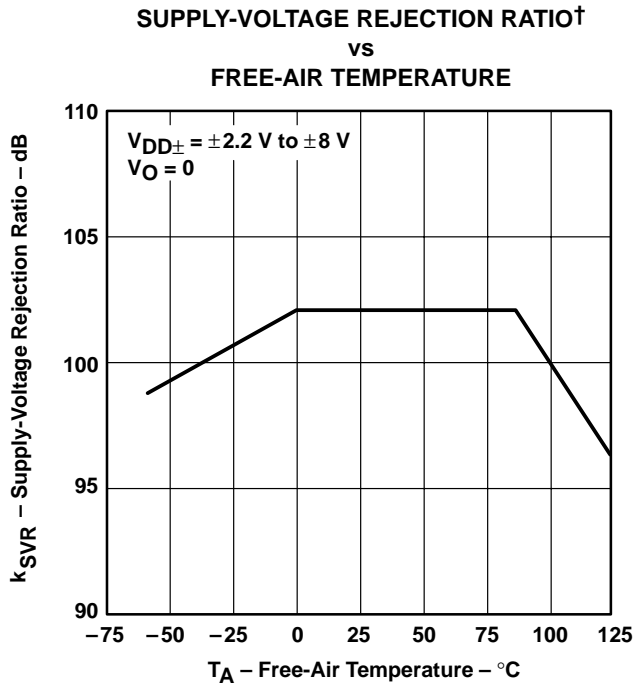

Figure 36

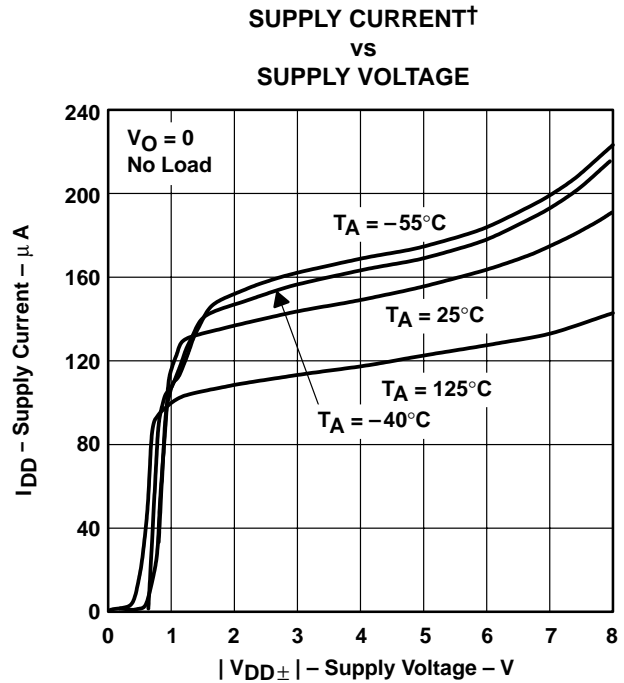

Figure 37

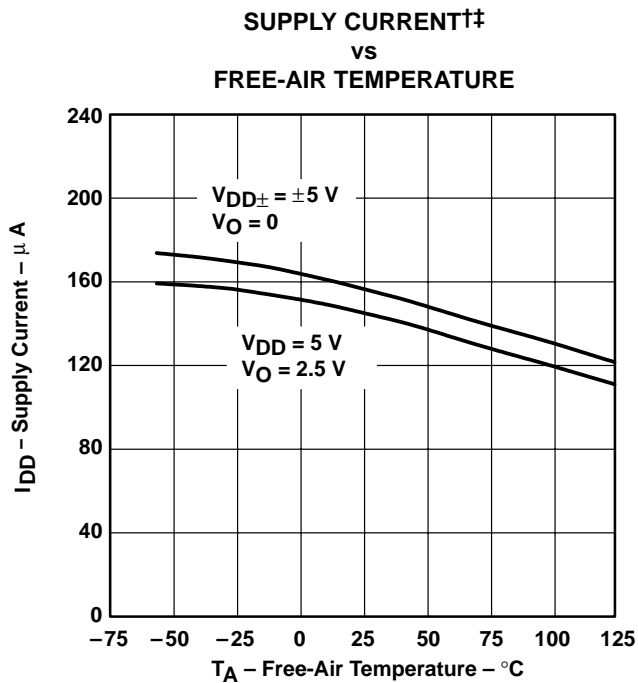

Figure 38

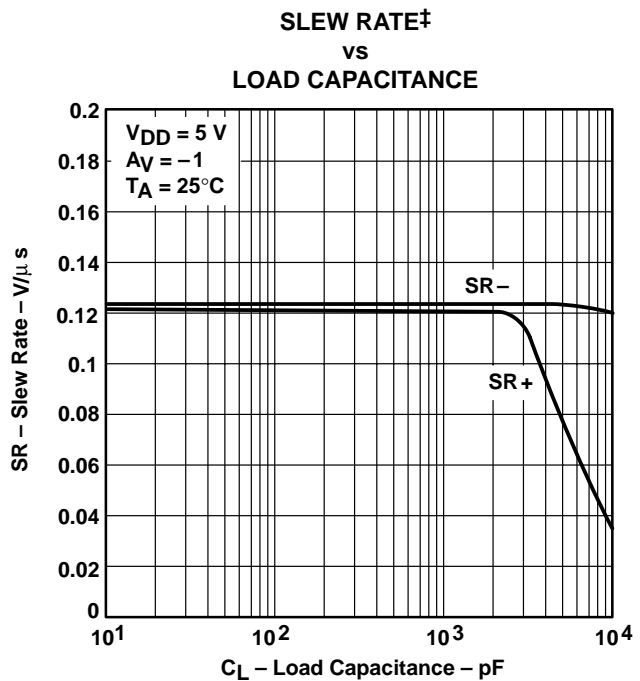
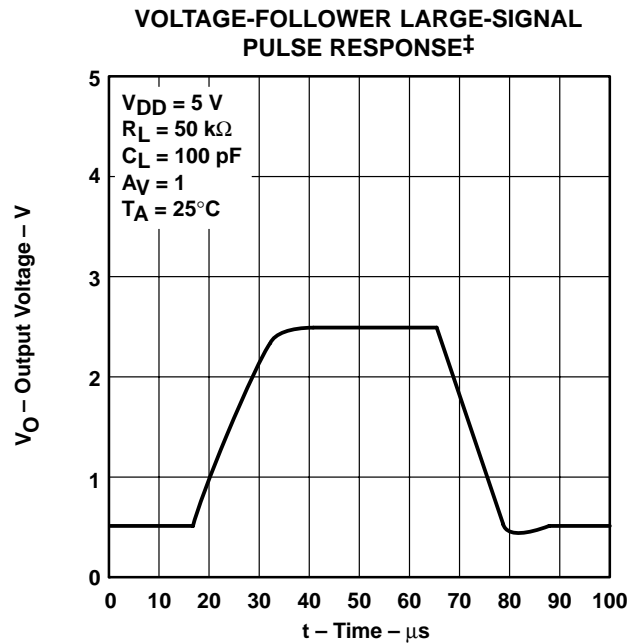
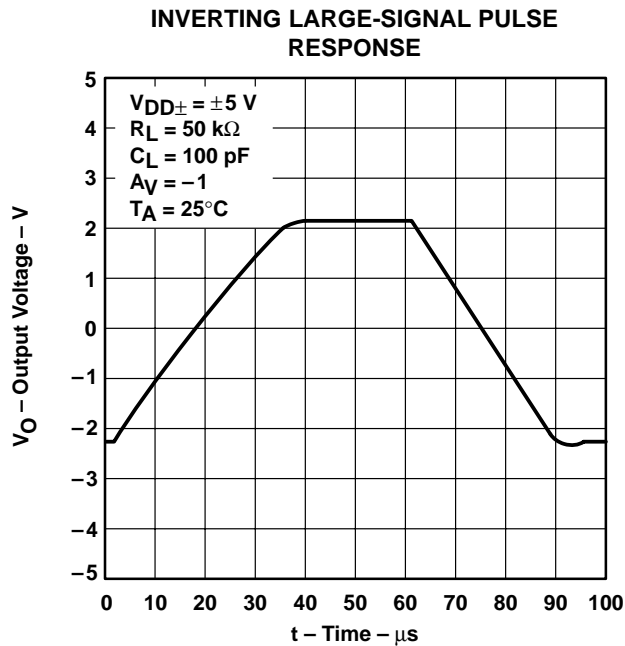
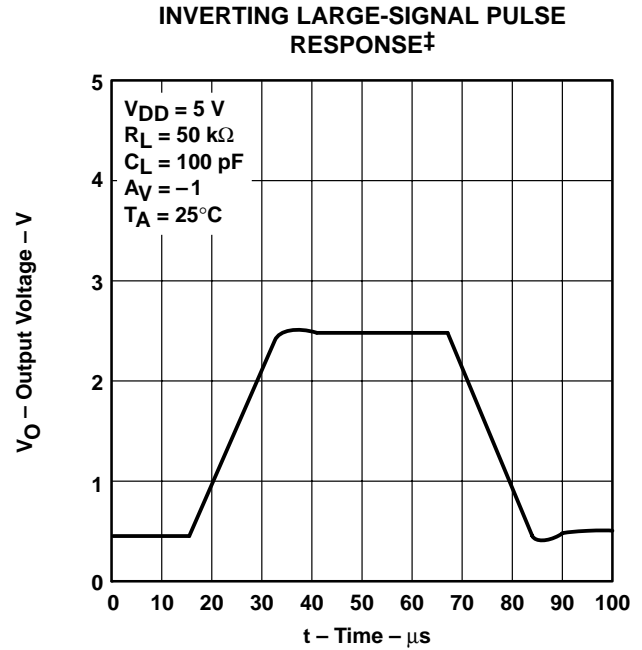
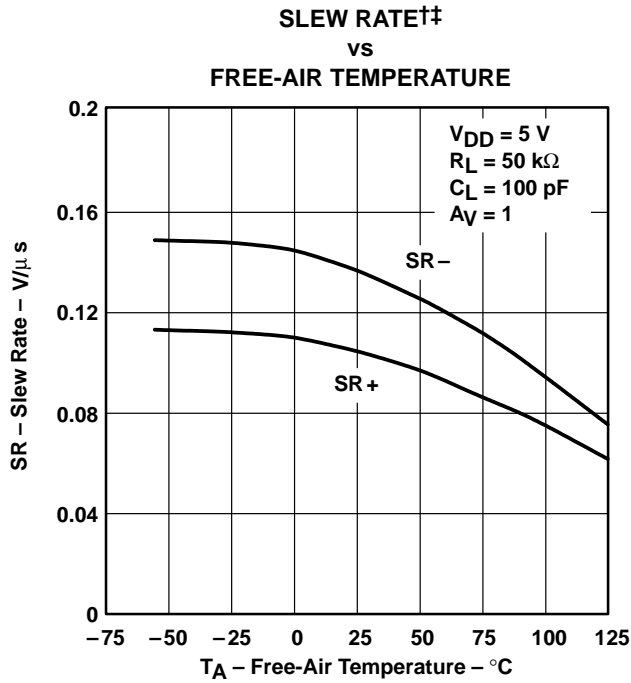

Figure 39

† Data at high and low temperatures are applicable only within the rated operating free-air temperature ranges of the various devices.

‡ For curves where $V_{DD} = 5 \text{ V}$, all loads are referenced to 2.5 V.

TYPICAL CHARACTERISTICS



† Data at high and low temperatures are applicable only within the rated operating free-air temperature ranges of the various devices.

‡ For curves where $V_{DD} = 5\text{ V}$, all loads are referenced to 2.5 V.

TYPICAL CHARACTERISTICS

VOLTAGE-FOLLOWER LARGE-SIGNAL PULSE RESPONSE

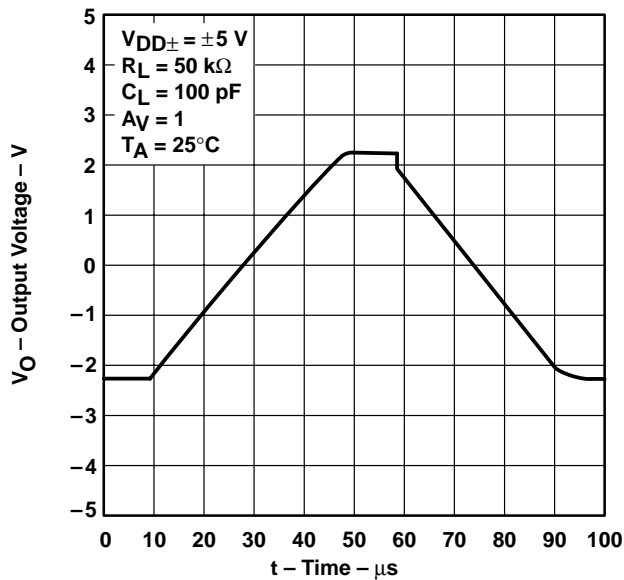

Figure 44

INVERTING SMALL-SIGNAL PULSE RESPONSE†

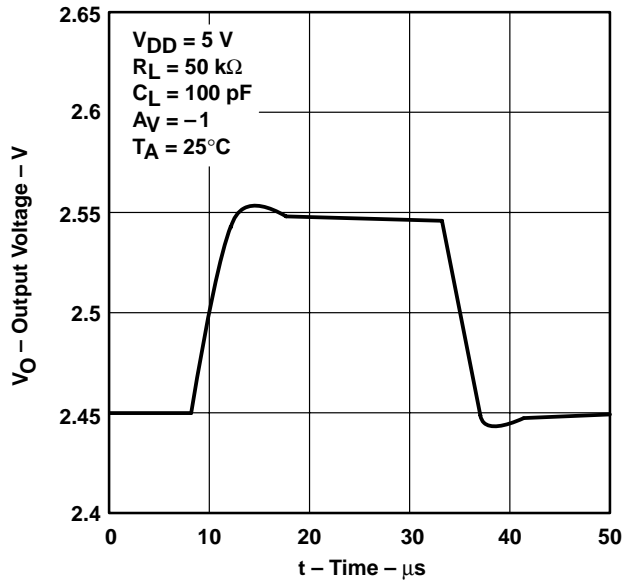

Figure 45

INVERTING SMALL-SIGNAL PULSE RESPONSE

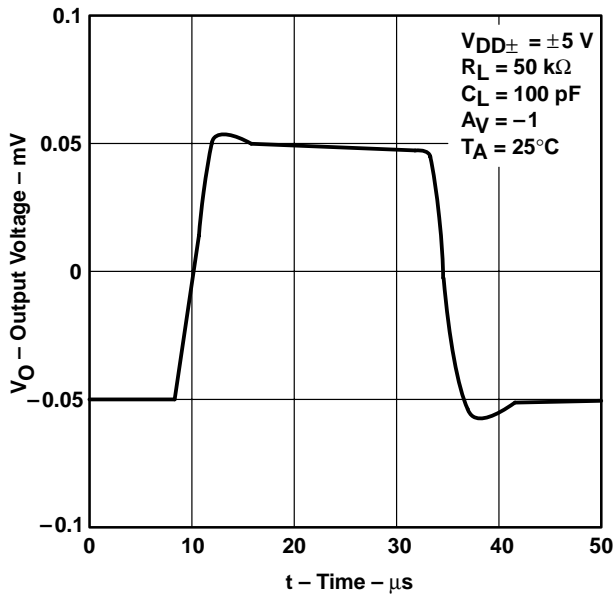

Figure 46

VOLTAGE-FOLLOWER SMALL-SIGNAL PULSE RESPONSE†

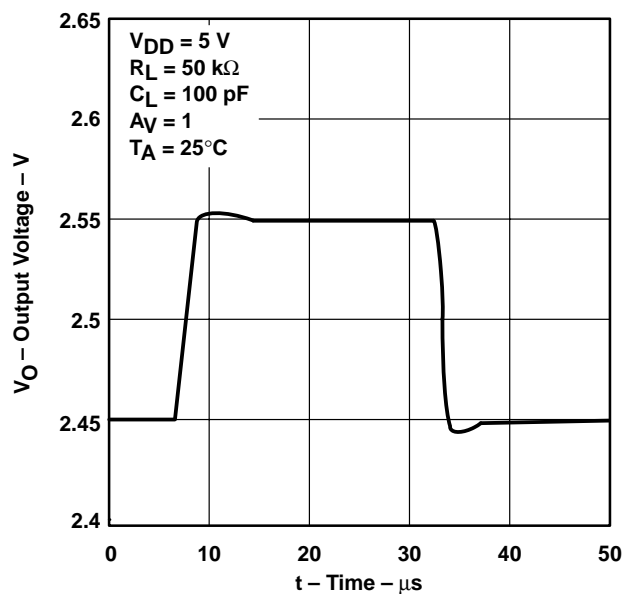

Figure 47

† For curves where $V_{DD} = 5$ V, all loads are referenced to 2.5 V.

TYPICAL CHARACTERISTICS

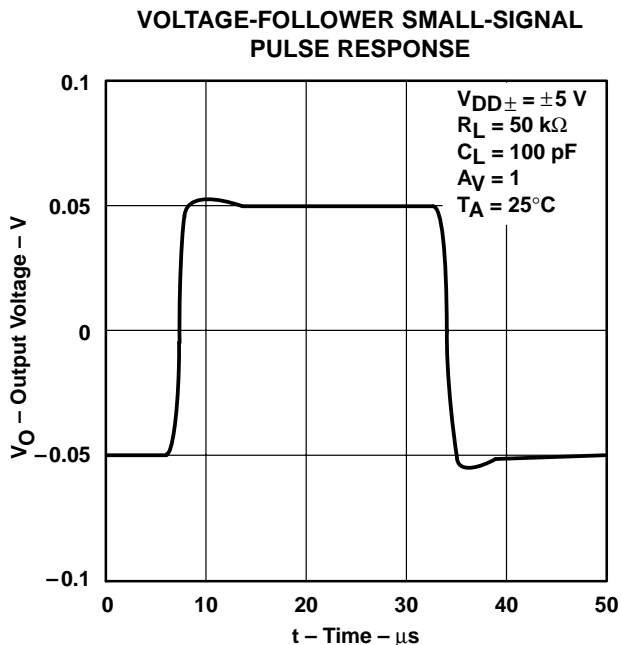

Figure 48

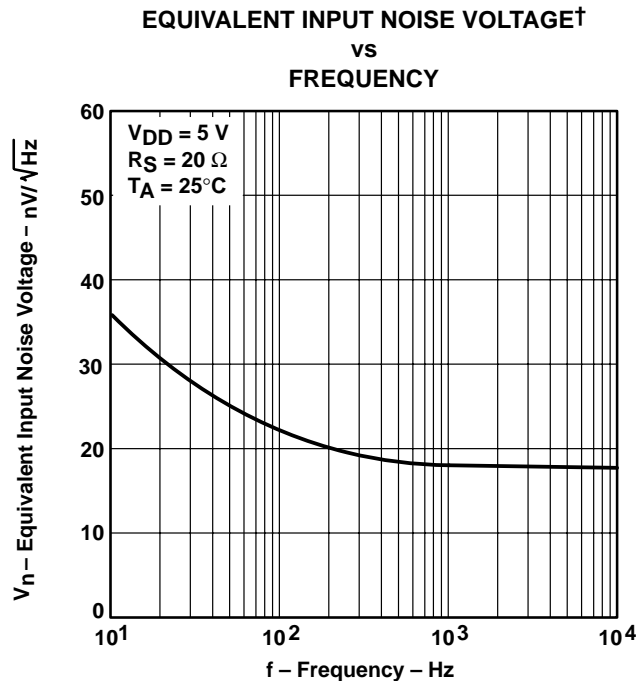

Figure 49

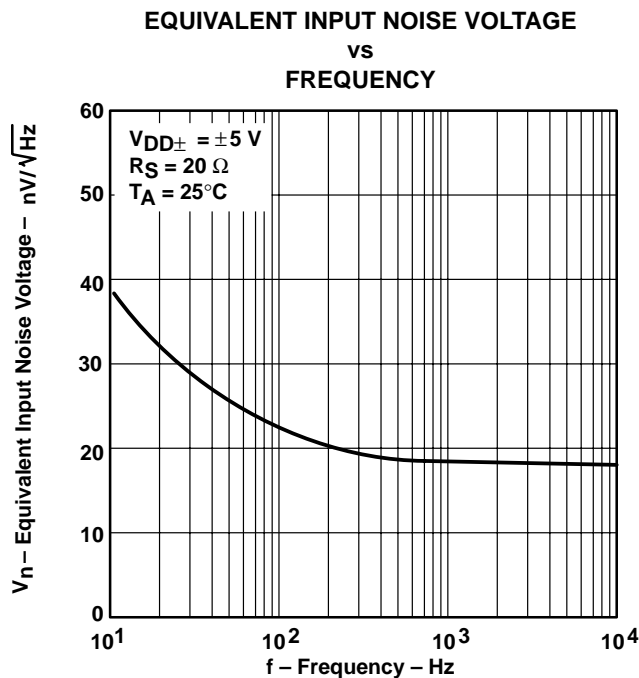

Figure 50

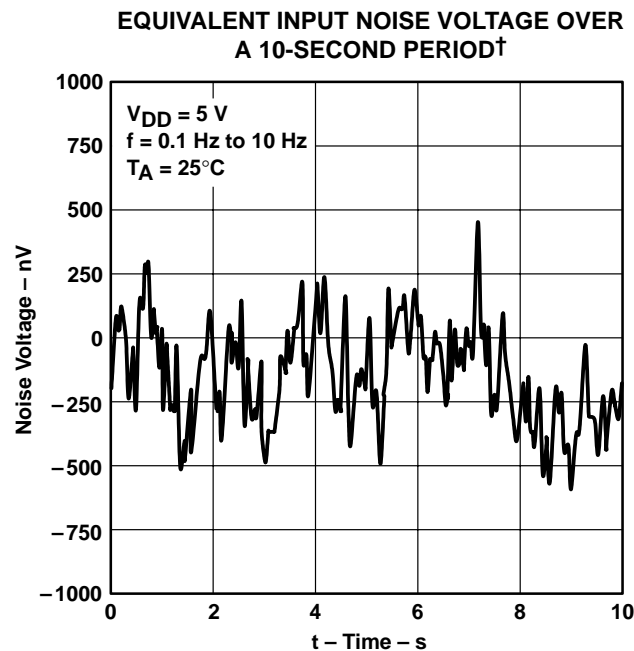

Figure 51

† For curves where $V_{DD} = 5 \text{ V}$, all loads are referenced to 2.5 V .

TYPICAL CHARACTERISTICS

**INTEGRATED NOISE VOLTAGE
 VS
 FREQUENCY**

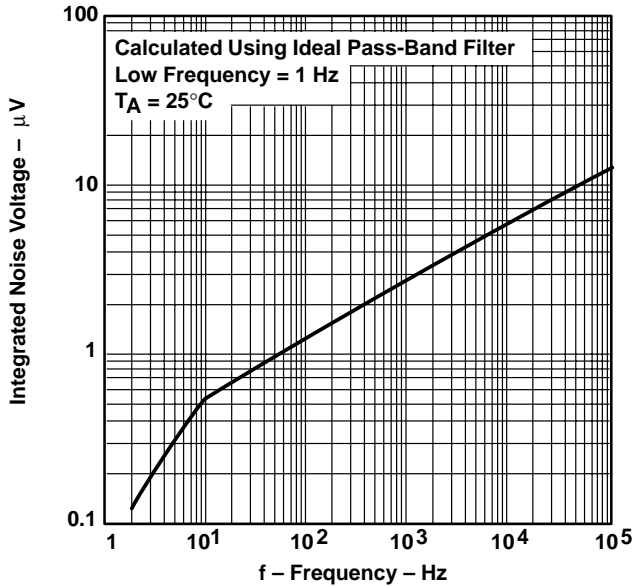

Figure 52

**TOTAL HARMONIC DISTORTION PLUS NOISE†
 VS
 FREQUENCY**

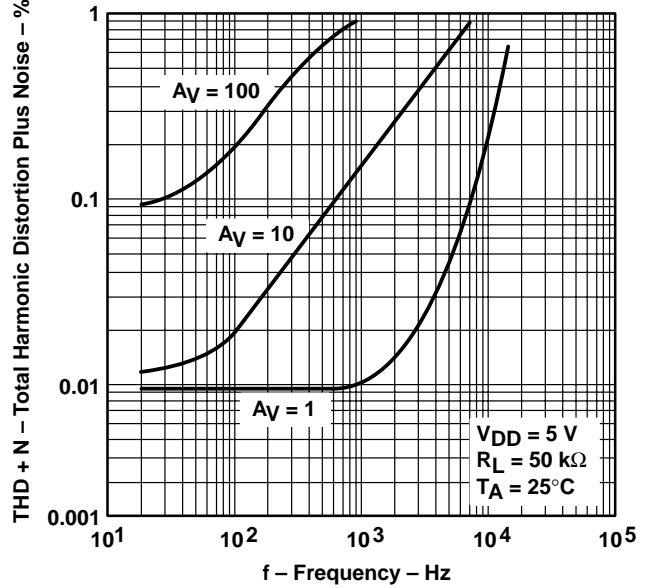

Figure 53

**GAIN-BANDWIDTH PRODUCT‡
 VS
 FREE-AIR TEMPERATURE**

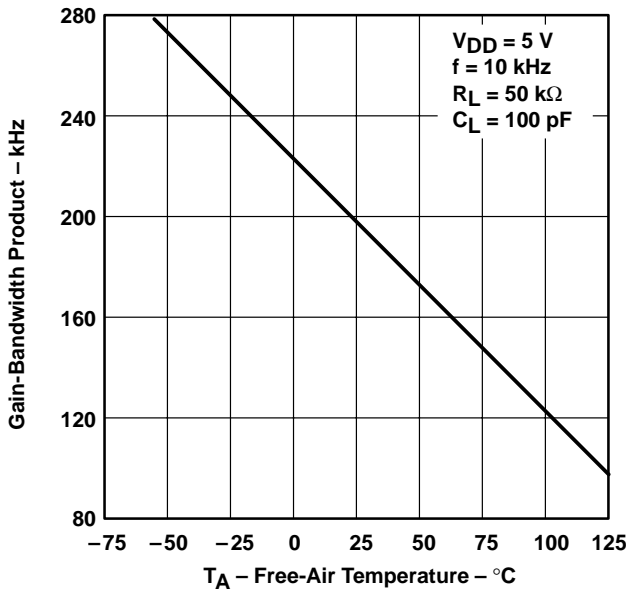

Figure 54

**GAIN-BANDWIDTH PRODUCT
 VS
 SUPPLY VOLTAGE**

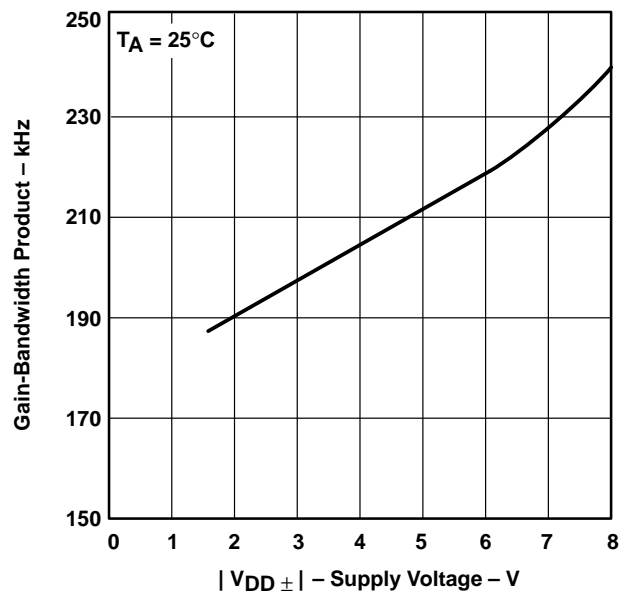

Figure 55

† For curves where $V_{DD} = 5\text{ V}$, all loads are referenced to 2.5 V .

‡ Data at high and low temperatures are applicable only within the rated operating free-air temperature ranges of the various devices.

TYPICAL CHARACTERISTICS

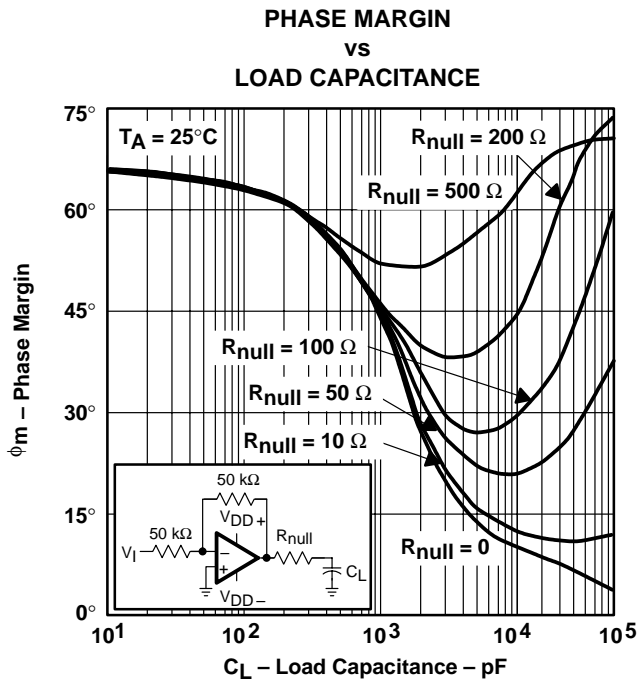

Figure 56

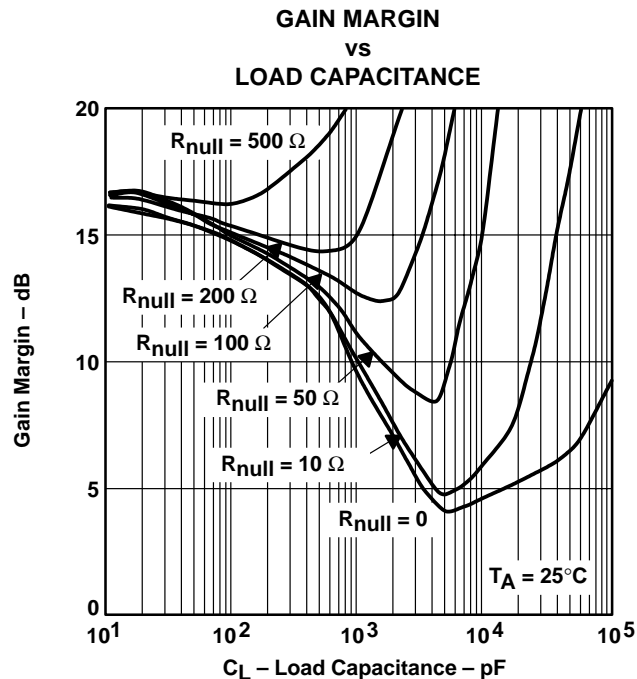

Figure 57

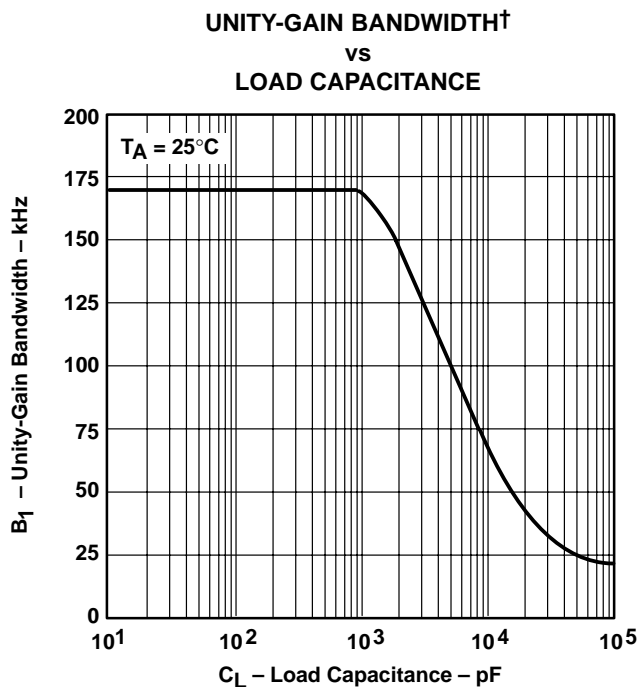

Figure 58

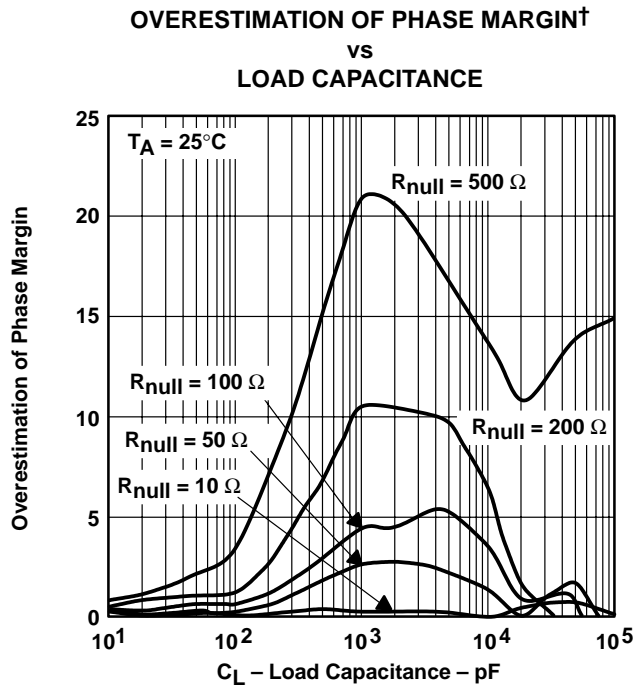

Figure 59

† See application information

APPLICATION INFORMATION

driving large capacitive loads

The TLC225x is designed to drive larger capacitive loads than most CMOS operational amplifiers. Figure 56 and Figure 57 illustrate its ability to drive loads up to 1000 pF while maintaining good gain and phase margins ($R_{null} = 0$).

A smaller series resistor (R_{null}) at the output of the device (see Figure 60) improves the gain and phase margins when driving large capacitive loads. Figure 56 and Figure 57 show the effects of adding series resistances of 10 Ω , 50 Ω , 100 Ω , 200 Ω , and 500 Ω . The addition of this series resistor has two effects: the first is that it adds a zero to the transfer function and the second is that it reduces the frequency of the pole associated with the output load in the transfer function.

The zero introduced to the transfer function is equal to the series resistance times the load capacitance. To calculate the improvement in phase margin, equation 1 can be used.

$$\Delta\phi_{m1} = \tan^{-1} \left(2 \times \pi \times \text{UGBW} \times R_{null} \times C_L \right) \tag{1}$$

Where :

- $\Delta\phi_{m1}$ = Improvement in phase margin
- UGBW = Unity-gain bandwidth frequency
- R_{null} = Output series resistance
- C_L = Load capacitance

The unity-gain bandwidth (UGBW) frequency decreases as the capacitive load increases (see Figure 58). To use equation 1, UGBW must be approximated from Figure 58.

Using equation 1 alone overestimates the improvement in phase margin, as illustrated in Figure 59. The overestimation is caused by the decrease in the frequency of the pole associated with the load, thus providing additional phase shift and reducing the overall improvement in phase margin.

Using Figure 60, with equation 1 enables the designer to choose the appropriate output series resistance to optimize the design of circuits driving large capacitance loads.

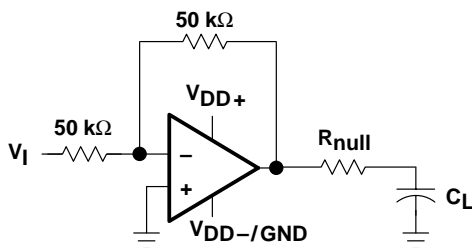

Figure 60. Series-Resistance Circuit

APPLICATION INFORMATION

macromodel information

Macromodel information provided was derived using MicroSim *Parts*™, the model generation software used with MicroSim *PSpice*™. The Boyle macromodel (see Note 5) and subcircuit in Figure 61 are generated using the TLC225x typical electrical and operating characteristics at $T_A = 25^\circ\text{C}$. Using this information, output simulations of the following key parameters can be generated to a tolerance of 20% (in most cases):

- Maximum positive output voltage swing
- Maximum negative output voltage swing
- Slew rate
- Quiescent power dissipation
- Input bias current
- Open-loop voltage amplification
- Unity-gain frequency
- Common-mode rejection ratio
- Phase margin
- DC output resistance
- AC output resistance
- Short-circuit output current limit

NOTE 5: G. R. Boyle, B. M. Cohn, D. O. Pederson, and J. E. Solomon, "Macromodeling of Integrated Circuit Operational Amplifiers", *IEEE Journal of Solid-State Circuits*, SC-9, 353 (1974).

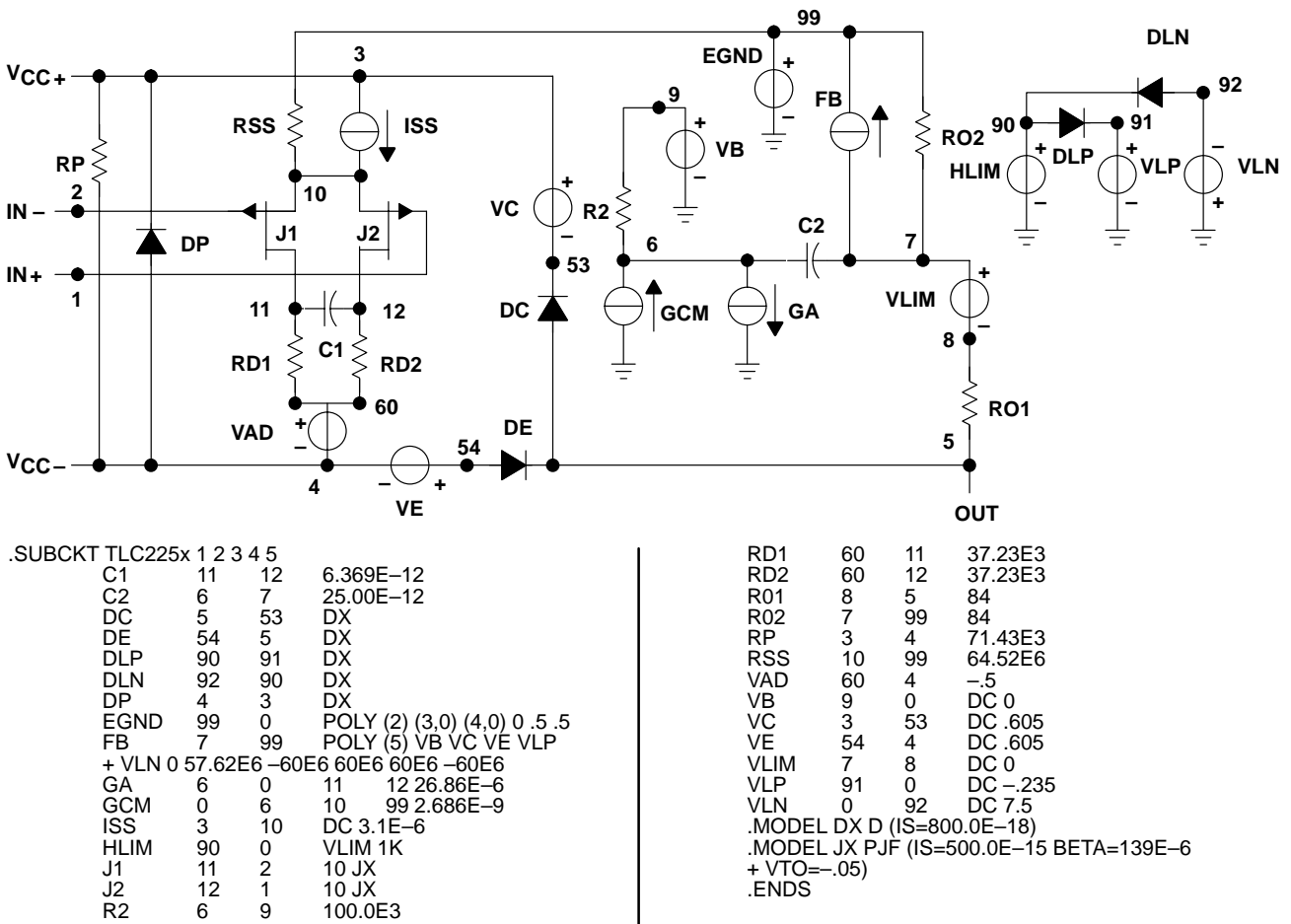

Figure 61. Boyle Macromodel and Subcircuit

PSpice and *Parts* are trademarks of MicroSim Corporation.

TLC225x, TLC225xA
Advanced LinCMOS™ RAIL-TO-RAIL
VERY LOW-POWER OPERATIONAL AMPLIFIERS

SLOS176D – FEBRUARY 1997 – REVISED MARCH 2001

MECHANICAL INFORMATION

D (R-PDSO-G)**

PLASTIC SMALL-OUTLINE PACKAGE

14 PIN SHOWN

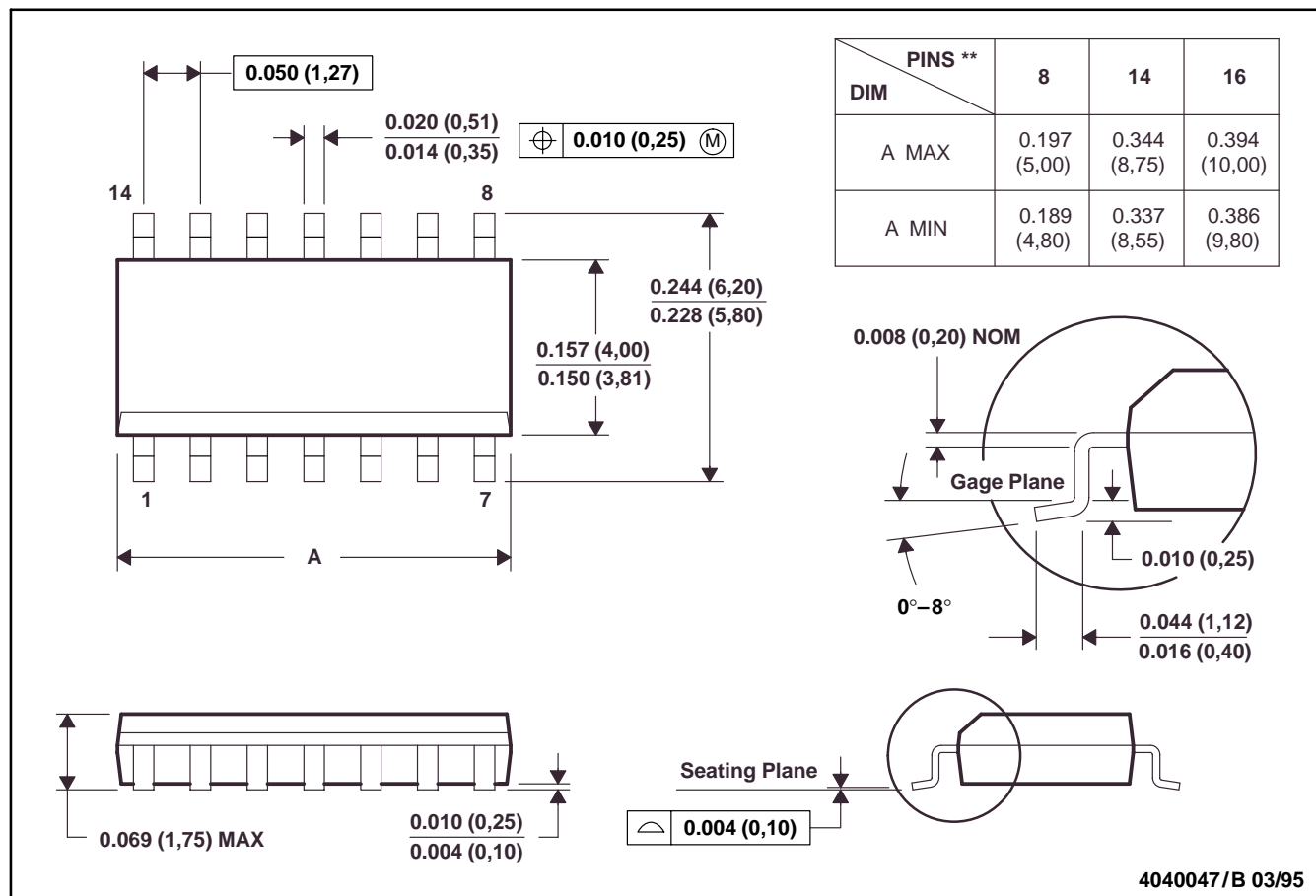

- NOTES: A. All linear dimensions are in inches (millimeters).
 B. This drawing is subject to change without notice.
 C. Body dimensions do not include mold flash or protrusion, not to exceed 0.006 (0,15).
 D. Four center pins are connected to die mount pad.
 E. Falls within JEDEC MS-012

TLC225x, TLC225xA
Advanced LinCMOS™ RAIL-TO-RAIL
VERY LOW-POWER OPERATIONAL AMPLIFIERS

SLOS176D – FEBRUARY 1997 – REVISED MARCH 2001

MECHANICAL INFORMATION

FK (S-CQCC-N)**

LEADLESS CERAMIC CHIP CARRIER

28 TERMINAL SHOWN

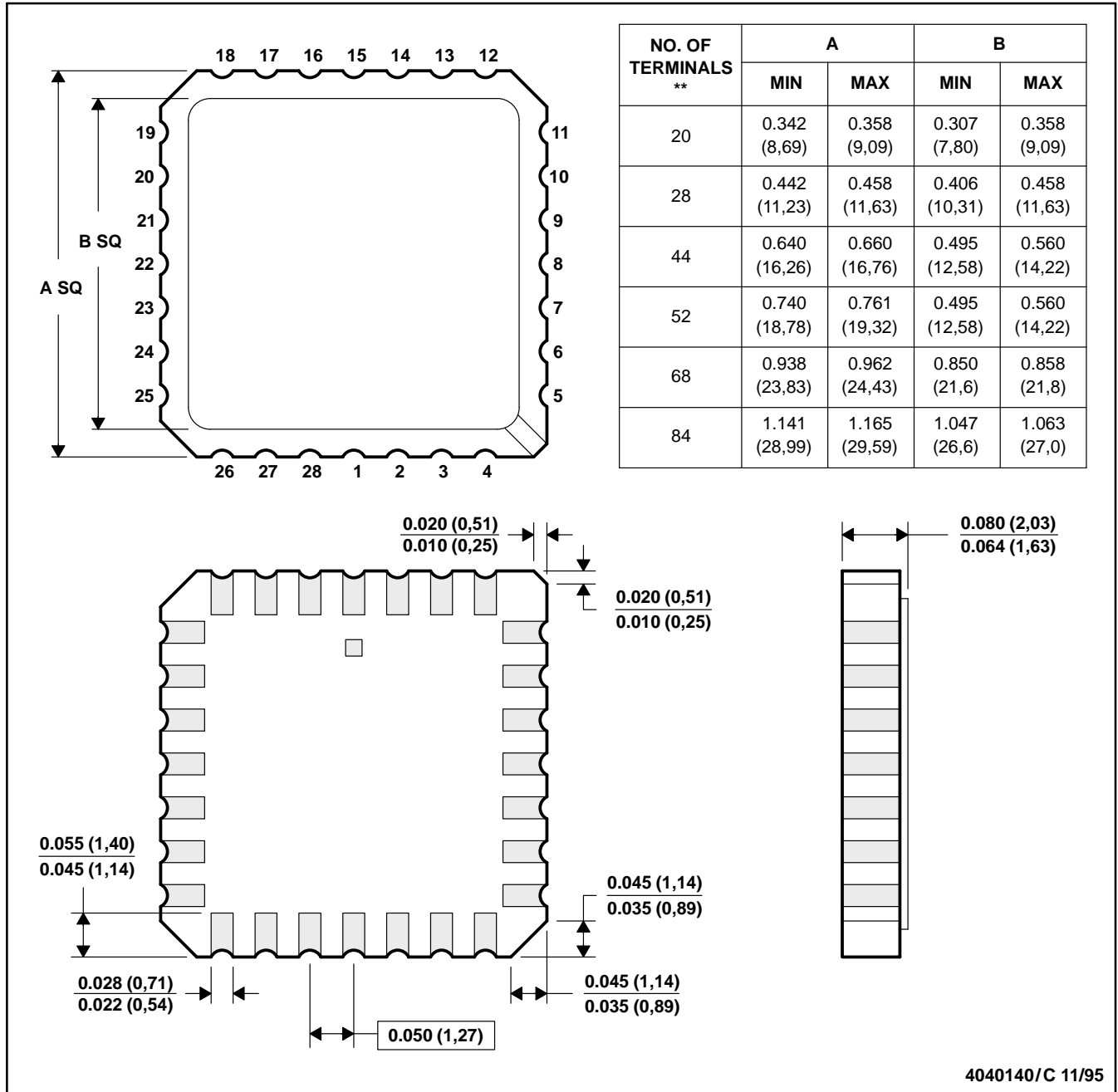

- NOTES: A. All linear dimensions are in inches (millimeters).
 B. This drawing is subject to change without notice.
 C. This package can be hermetically sealed with a metal lid.
 D. The terminals are gold plated.
 E. Falls within JEDEC MS-004

TLC225x, TLC225xA
Advanced LinCMOS™ RAIL-TO-RAIL
VERY LOW-POWER OPERATIONAL AMPLIFIERS

SLOS176D – FEBRUARY 1997 – REVISED MARCH 2001

MECHANICAL INFORMATION

J (R-GDIP-T)**

CERAMIC DUAL-IN-LINE PACKAGE

14 PIN SHOWN

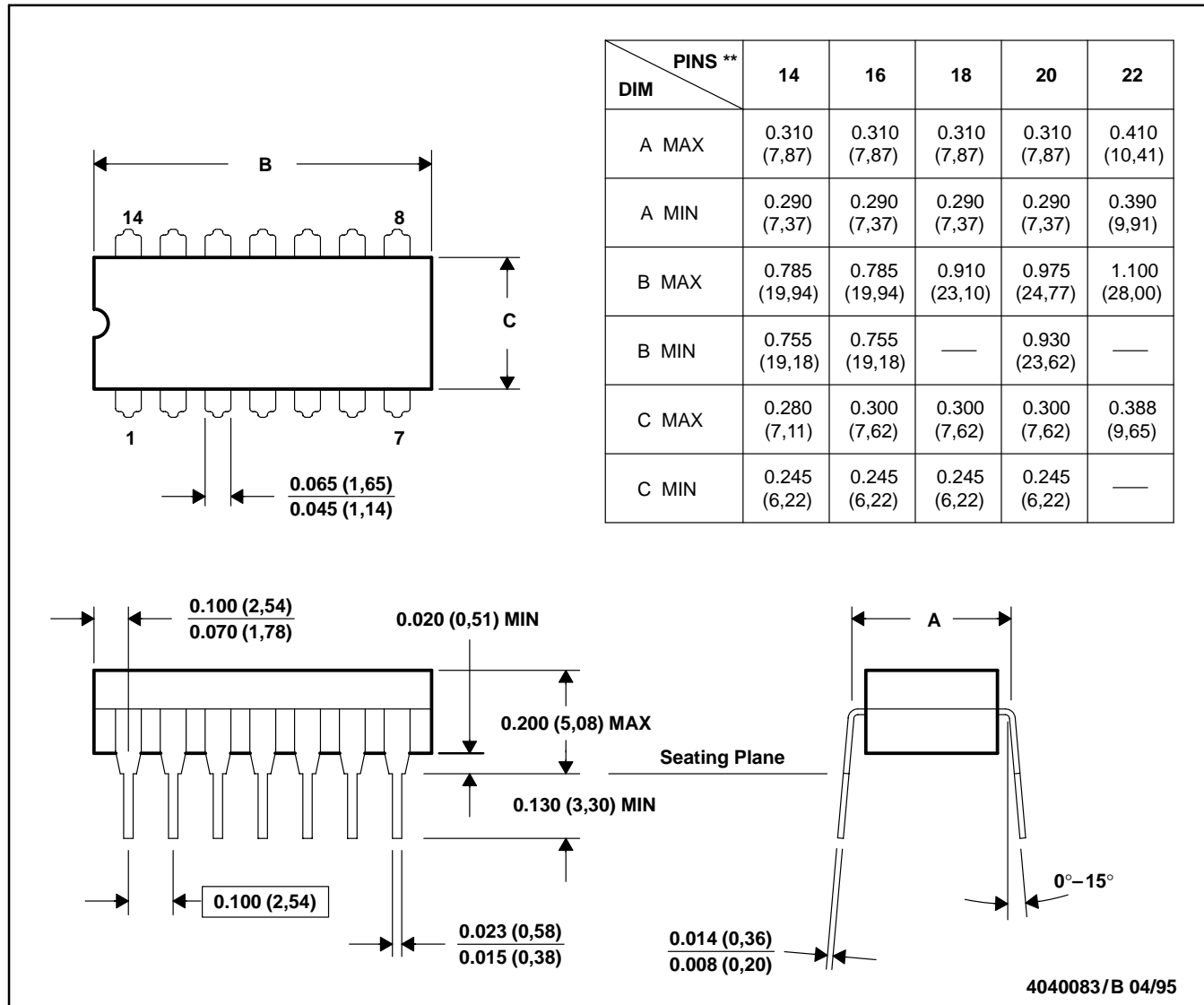

- NOTES: A. All linear dimensions are in inches (millimeters).
 B. This drawing is subject to change without notice.
 C. This package can be hermetically sealed with a ceramic lid using glass frit.
 D. Index point is provided on cap for terminal identification only.
 E. Falls within MIL-STD-1835 GDIP1-T14, GDIP1-T16, GDIP1-T18, GDIP1-T20, and GDIP1-T22

MECHANICAL INFORMATION

JG (R-GDIP-T8)

CERAMIC DUAL-IN-LINE PACKAGE

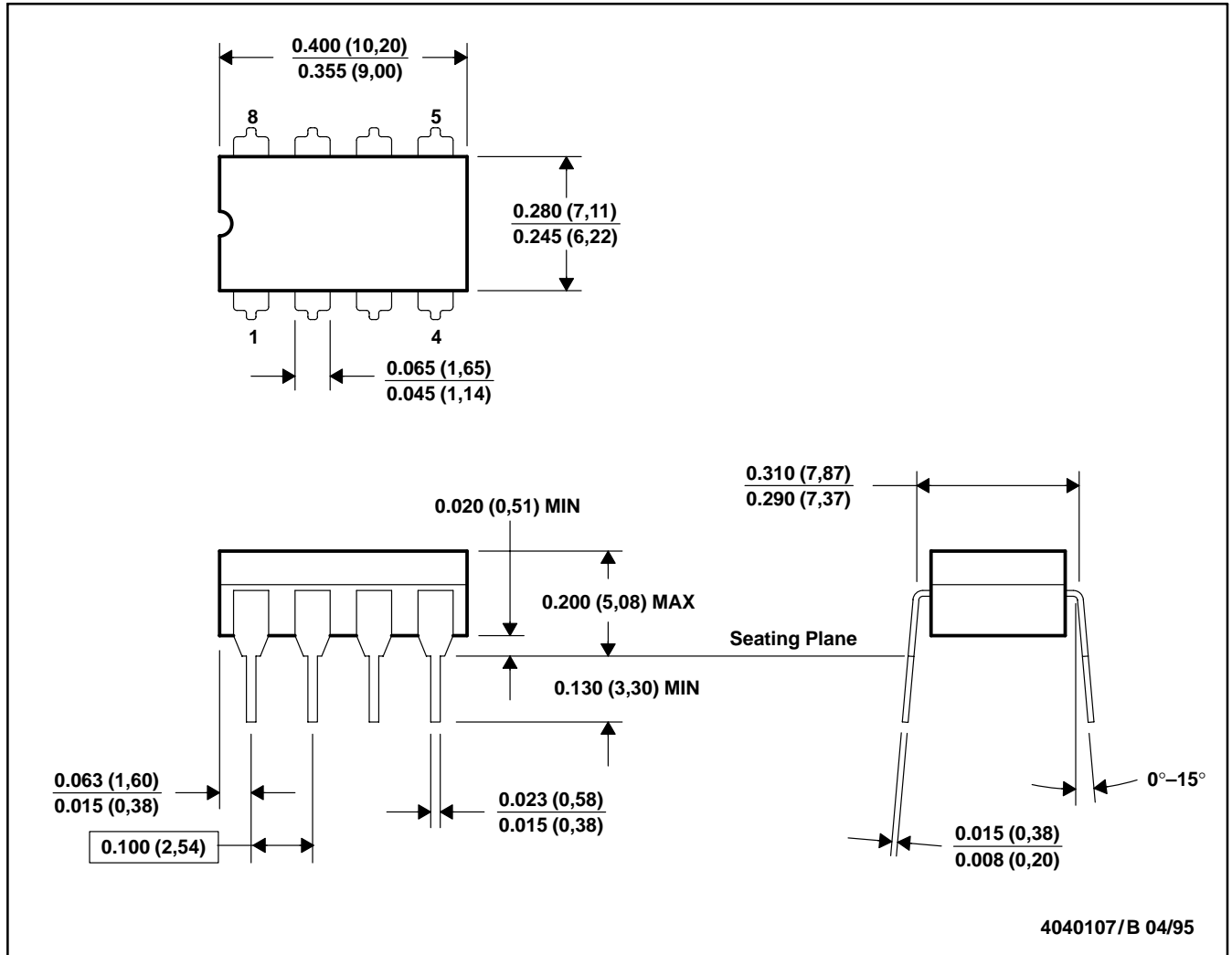

- NOTES: A. All linear dimensions are in inches (millimeters).
 B. This drawing is subject to change without notice.
 C. This package can be hermetically sealed with a ceramic lid using glass frit.
 D. Index point is provided on cap for terminal identification and/or on pressed ceramic glass frit seal.
 E. Falls within MIL-STD-1835 GDIP1-T8

TLC225x, TLC225xA
Advanced LinCMOS™ RAIL-TO-RAIL
VERY LOW-POWER OPERATIONAL AMPLIFIERS

SLOS176D – FEBRUARY 1997 – REVISED MARCH 2001

MECHANICAL INFORMATION

N (R-PDIP-T)**

PLASTIC DUAL-IN-LINE PACKAGE

16 PIN SHOWN

DIM \ PINS **	14	16	18	20
A MAX	0.775 (19,69)	0.775 (19,69)	0.920 (23,37)	0.975 (24,77)
A MIN	0.745 (18,92)	0.745 (18,92)	0.850 (21,59)	0.940 (23,88)

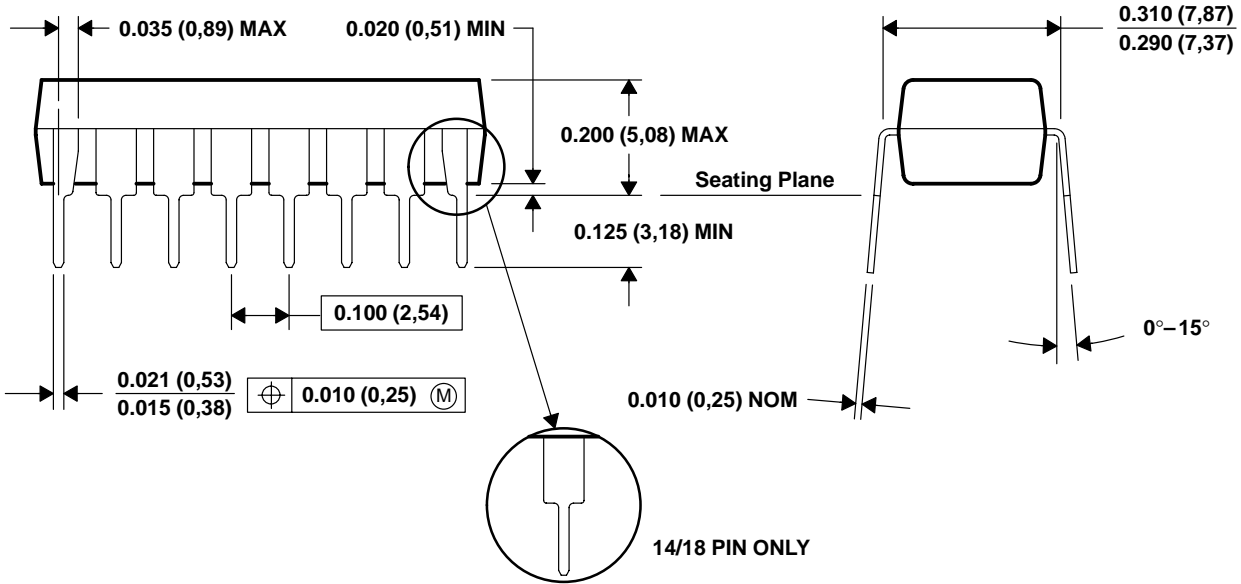
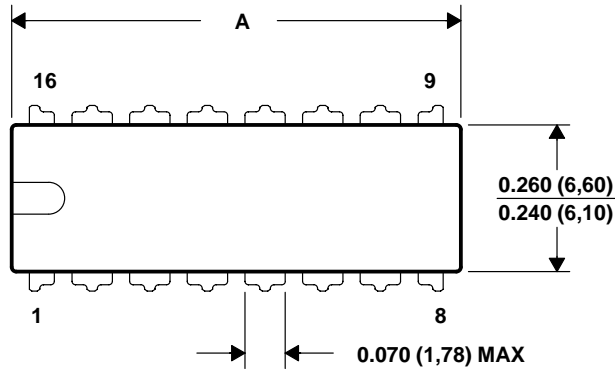

4040049/C 08/95

- NOTES: A. All linear dimensions are in inches (millimeters).
 B. This drawing is subject to change without notice.
 C. Falls within JEDEC MS-001 (20 pin package is shorter than MS-001.)

MECHANICAL INFORMATION

P (R-PDIP-T8)

PLASTIC DUAL-IN-LINE PACKAGE

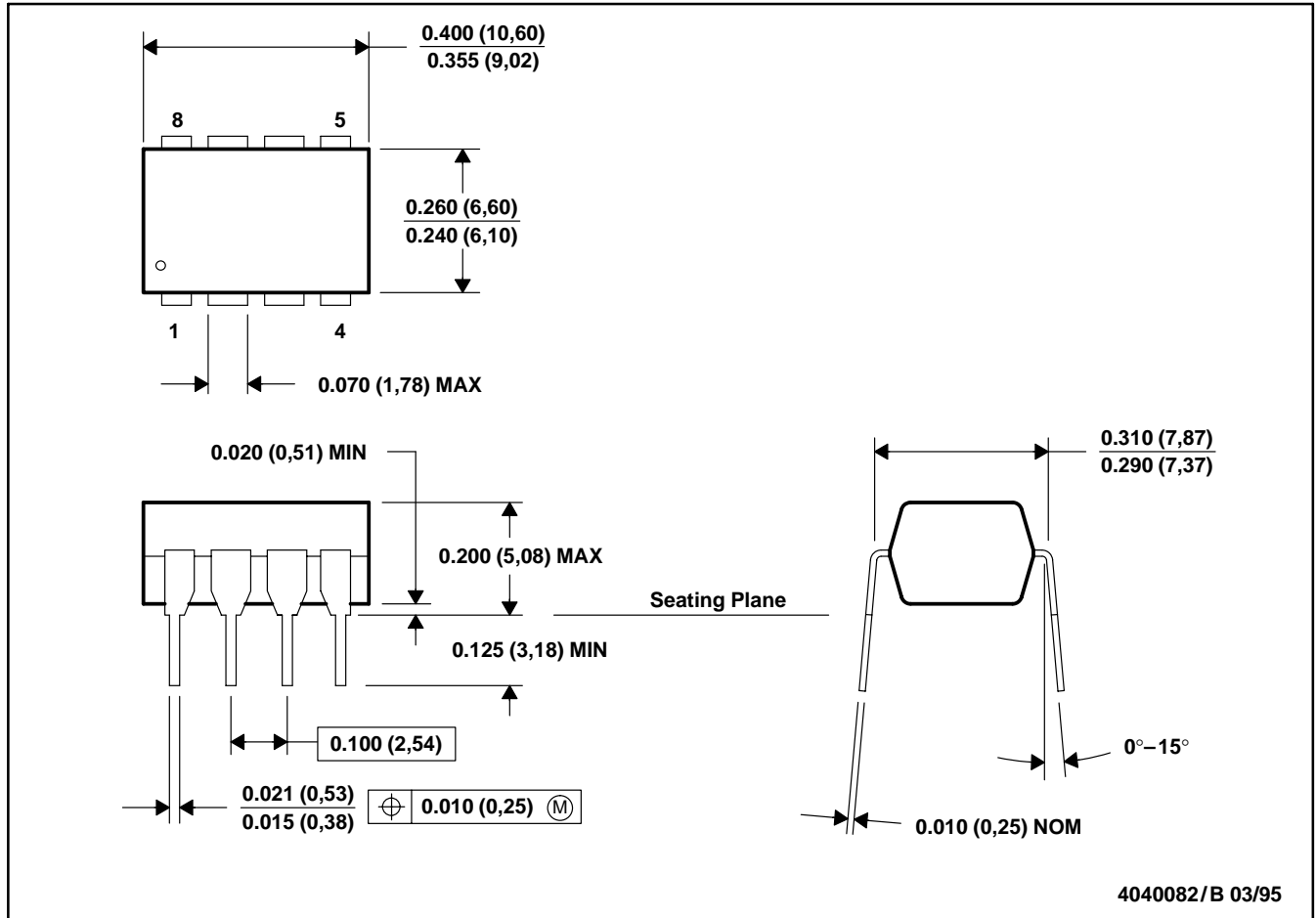

- NOTES: A. All linear dimensions are in inches (millimeters).
 B. This drawing is subject to change without notice.
 C. Falls within JEDEC MS-001

TLC225x, TLC225xA
Advanced LinCMOS™ RAIL-TO-RAIL
VERY LOW-POWER OPERATIONAL AMPLIFIERS

SLOS176D – FEBRUARY 1997 – REVISED MARCH 2001

MECHANICAL INFORMATION

PW (R-PDSO-G)**

PLASTIC SMALL-OUTLINE PACKAGE

14 PIN SHOWN

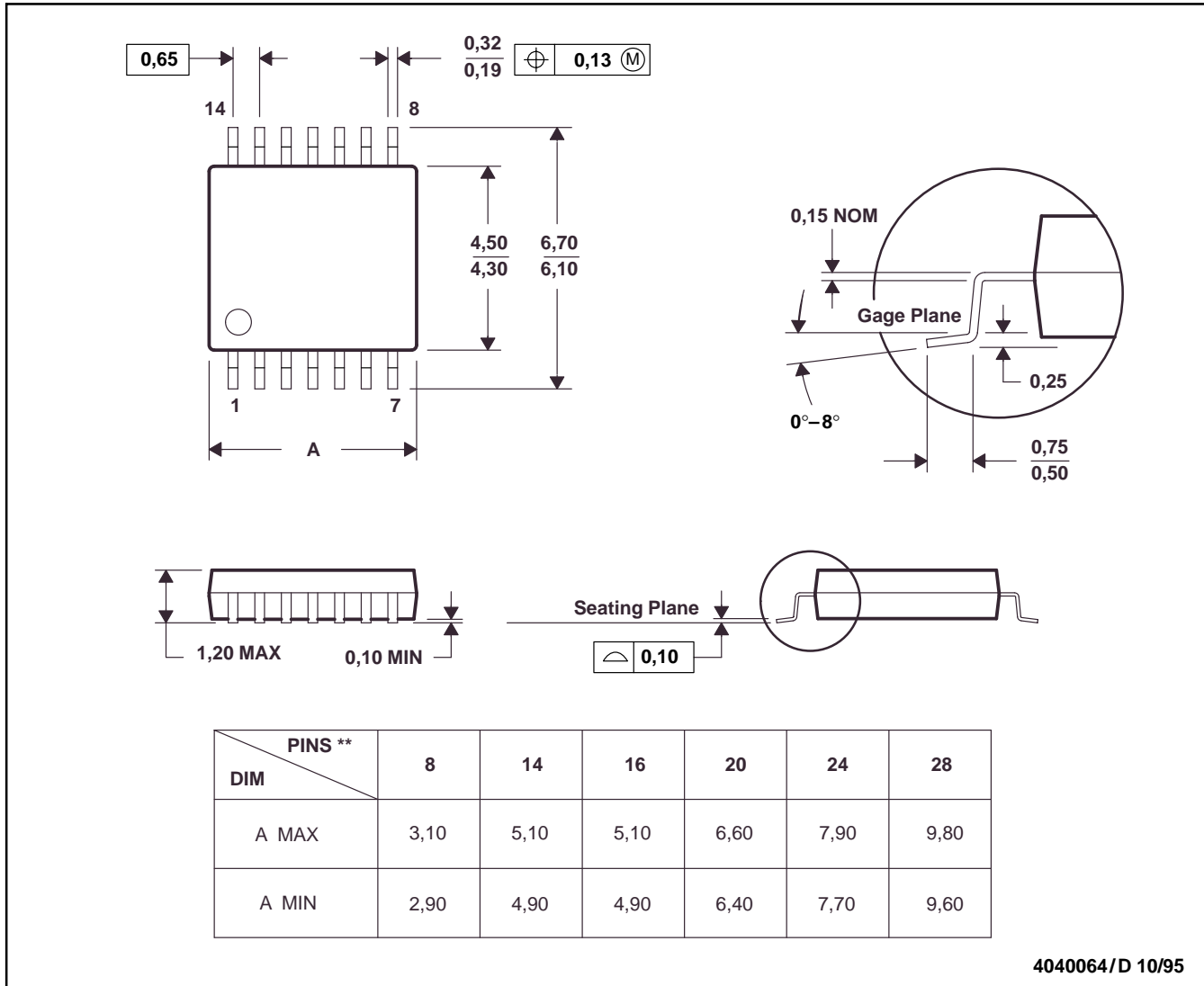

4040064/D 10/95

- NOTES: A. All linear dimensions are in millimeters.
 B. This drawing is subject to change without notice.
 C. Body dimensions do not include mold flash or protrusion not to exceed 0,15.
 D. Falls within JEDEC MO-153

MECHANICAL INFORMATION

U (S-GDFP-F10)

CERAMIC DUAL FLATPACK

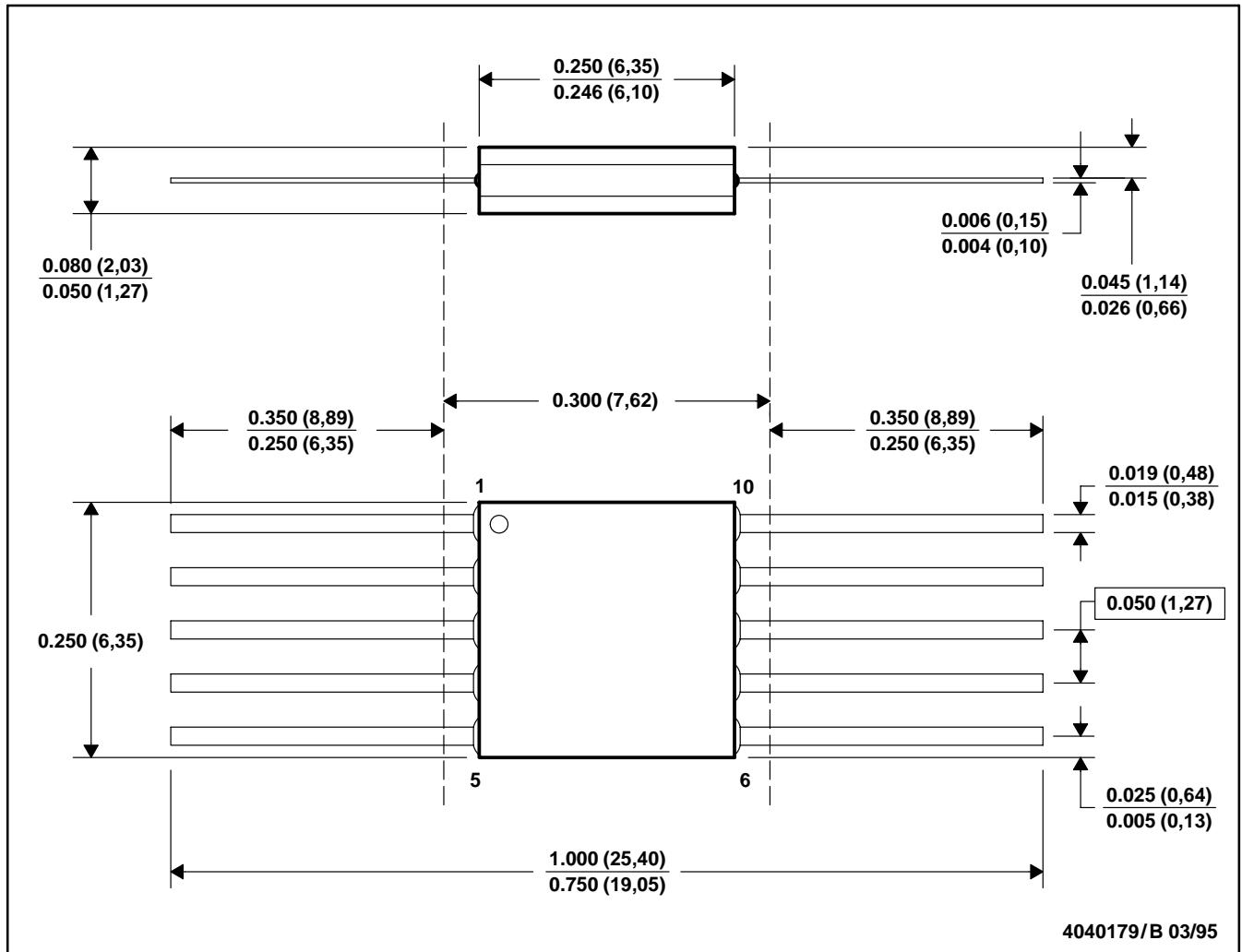

- NOTES: A. All linear dimensions are in inches (millimeters).
 B. This drawing is subject to change without notice.
 C. This package can be hermetically sealed with a ceramic lid using glass frit.
 D. Index point is provided on cap for terminal identification only.
 E. Falls within MIL STD 1835 GDFP1-F10 and JEDEC MO-092AA

TLC225x, TLC225xA
Advanced LinCMOS™ RAIL-TO-RAIL
VERY LOW-POWER OPERATIONAL AMPLIFIERS

SLOS176D – FEBRUARY 1997 – REVISED MARCH 2001

MECHANICAL INFORMATION

W (R-GDFP-F16)

CERAMIC DUAL FLATPACK

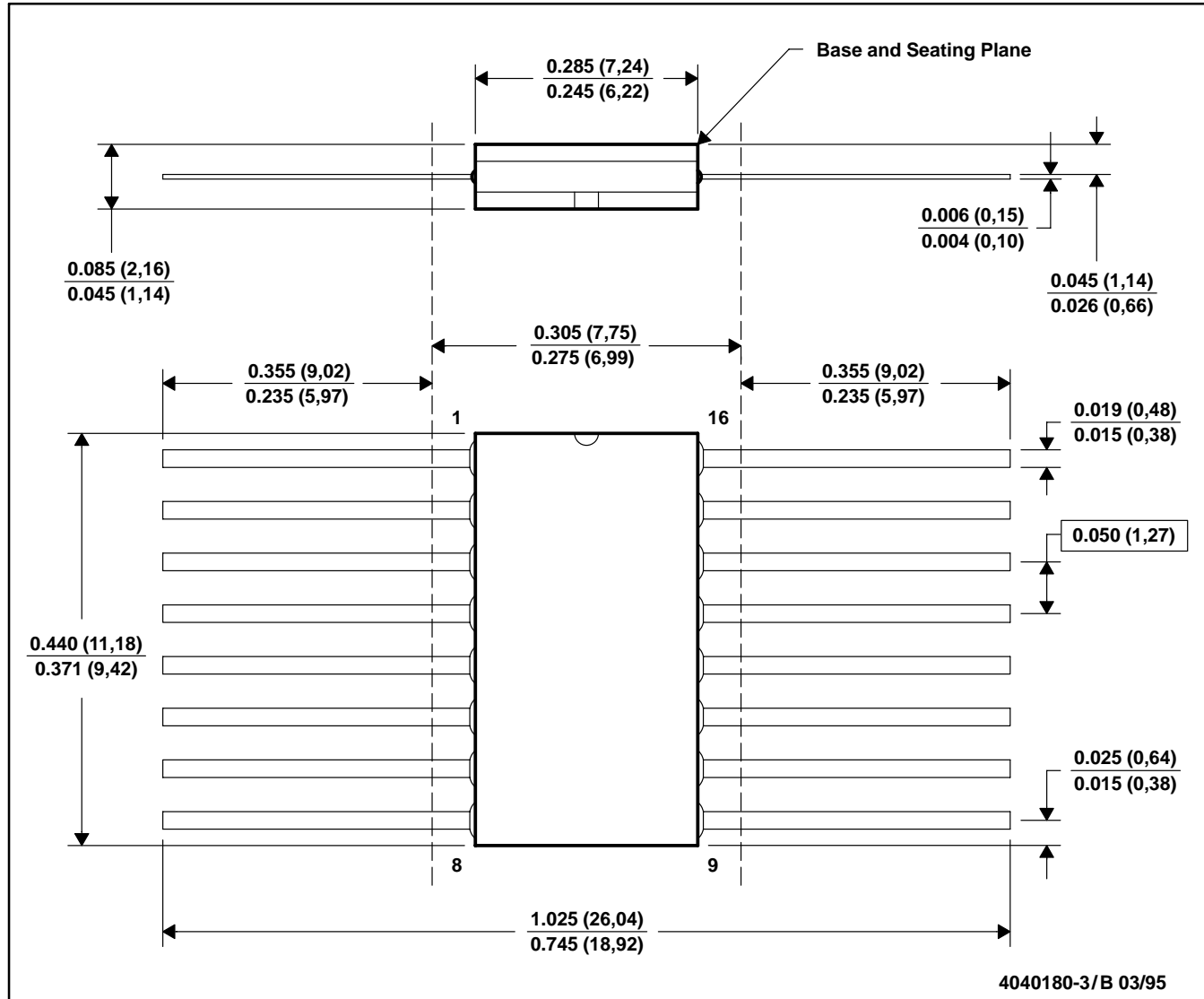

- NOTES: A. All linear dimensions are in inches (millimeters).
 B. This drawing is subject to change without notice.
 C. This package can be hermetically sealed with a ceramic lid using glass frit.
 D. Index point is provided on cap for terminal identification only.
 E. Falls within MIL-STD-1835 GDFP1-F16 and JEDEC MO-092AC



PACKAGING INFORMATION

Orderable Device	Status ⁽¹⁾	Package Type	Package Drawing	Pins	Package Qty	Eco Plan ⁽²⁾	Lead/Ball Finish	MSL Peak Temp ⁽³⁾
5962-9564001NXDR	ACTIVE	SOIC	D	8	2500	TBD	CU NIPDAU	Level-1-220C-UNLIM
5962-9564001Q2A	ACTIVE	LCCC	FK	20	1	TBD	POST-PLATE	Level-NC-NC-NC
5962-9564001QHA	ACTIVE	CFP	U	10	1	TBD	A42 SNPB	Level-NC-NC-NC
5962-9564001QPA	ACTIVE	CDIP	JG	8	1	TBD	A42 SNPB	Level-NC-NC-NC
5962-9564002NYDR	ACTIVE	SOIC	D	14	2500	TBD	CU NIPDAU	Level-1-220C-UNLIM
5962-9564002Q2A	ACTIVE	LCCC	FK	20	1	TBD	POST-PLATE	Level-NC-NC-NC
5962-9564002QCA	ACTIVE	CDIP	J	14	1	TBD	A42 SNPB	Level-NC-NC-NC
5962-9564002QDA	ACTIVE	CFP	W	14	1	TBD	A42 SNPB	Level-NC-NC-NC
5962-9564003NXDR	ACTIVE	SOIC	D	8	2500	TBD	CU NIPDAU	Level-1-220C-UNLIM
5962-9564003Q2A	ACTIVE	LCCC	FK	20	1	TBD	POST-PLATE	Level-NC-NC-NC
5962-9564003QHA	ACTIVE	CFP	U	10	1	TBD	A42 SNPB	Level-NC-NC-NC
5962-9564003QPA	ACTIVE	CDIP	JG	8	1	TBD	A42 SNPB	Level-NC-NC-NC
5962-9564004NYDR	ACTIVE	SOIC	D	14	2500	TBD	CU NIPDAU	Level-1-220C-UNLIM
5962-9564004Q2A	ACTIVE	LCCC	FK	20	1	TBD	POST-PLATE	Level-NC-NC-NC
5962-9564004QCA	ACTIVE	CDIP	J	14	1	TBD	A42 SNPB	Level-NC-NC-NC
5962-9564004QDA	ACTIVE	CFP	W	14	1	TBD	A42 SNPB	Level-NC-NC-NC
TLC2252AID	ACTIVE	SOIC	D	8	75	Green (RoHS & no Sb/Br)	CU NIPDAU	Level-1-260C-UNLIM
TLC2252AIDR	ACTIVE	SOIC	D	8	2500	Green (RoHS & no Sb/Br)	CU NIPDAU	Level-1-260C-UNLIM
TLC2252AIP	ACTIVE	PDIP	P	8	50	Pb-Free (RoHS)	CU NIPDAU	Level-NC-NC-NC
TLC2252AIP E4	ACTIVE	PDIP	P	8	50	Pb-Free (RoHS)	CU NIPDAU	Level-NC-NC-NC
TLC2252AIPW	ACTIVE	TSSOP	PW	8	150	TBD	CU NIPDAU	Level-1-220C-UNLIM
TLC2252AIPWLE	OBSOLETE	TSSOP	PW	8		TBD	Call TI	Call TI
TLC2252AIPWR	ACTIVE	TSSOP	PW	8	2000	TBD	CU NIPDAU	Level-1-220C-UNLIM
TLC2252AMFKB	ACTIVE	LCCC	FK	20	1	TBD	POST-PLATE	Level-NC-NC-NC
TLC2252AMJGB	ACTIVE	CDIP	JG	8	1	TBD	A42 SNPB	Level-NC-NC-NC
TLC2252AMUB	ACTIVE	CFP	U	10	1	TBD	A42 SNPB	Level-NC-NC-NC
TLC2252AQD	ACTIVE	SOIC	D	8	75	Pb-Free (RoHS)	CU NIPDAU	Level-2-250C-1 YEAR/ Level-1-235C-UNLIM
TLC2252AQDR	ACTIVE	SOIC	D	8	2500	Pb-Free (RoHS)	CU NIPDAU	Level-2-250C-1 YEAR/ Level-1-235C-UNLIM
TLC2252CD	ACTIVE	SOIC	D	8	75	Green (RoHS & no Sb/Br)	CU NIPDAU	Level-1-260C-UNLIM
TLC2252CDR	ACTIVE	SOIC	D	8	2500	Green (RoHS & no Sb/Br)	CU NIPDAU	Level-1-260C-UNLIM
TLC2252CP	ACTIVE	PDIP	P	8	50	Pb-Free (RoHS)	CU NIPDAU	Level-NC-NC-NC
TLC2252CPE4	ACTIVE	PDIP	P	8	50	Pb-Free (RoHS)	CU NIPDAU	Level-NC-NC-NC
TLC2252CPW	ACTIVE	TSSOP	PW	8	150	TBD	CU NIPDAU	Level-1-220C-UNLIM
TLC2252CPWLE	OBSOLETE	TSSOP	PW	8		TBD	Call TI	Call TI
TLC2252CPWR	ACTIVE	TSSOP	PW	8	2000	TBD	CU NIPDAU	Level-1-220C-UNLIM

Orderable Device	Status ⁽¹⁾	Package Type	Package Drawing	Pins	Package Qty	Eco Plan ⁽²⁾	Lead/Ball Finish	MSL Peak Temp ⁽³⁾
TLC2252CPWRG4	ACTIVE	TSSOP	PW	8	2000	Green (RoHS & no Sb/Br)	CU NIPDAU	Level-1-260C-UNLIM
TLC2252ID	ACTIVE	SOIC	D	8	75	Green (RoHS & no Sb/Br)	CU NIPDAU	Level-1-260C-UNLIM
TLC2252IDR	ACTIVE	SOIC	D	8	2500	Green (RoHS & no Sb/Br)	CU NIPDAU	Level-1-260C-UNLIM
TLC2252IP	ACTIVE	PDIP	P	8	50	Pb-Free (RoHS)	CU NIPDAU	Level-NC-NC-NC
TLC2252IPE4	ACTIVE	PDIP	P	8	50	Pb-Free (RoHS)	CU NIPDAU	Level-NC-NC-NC
TLC2252MFKB	ACTIVE	LCCC	FK	20	1	TBD	POST-PLATE	Level-NC-NC-NC
TLC2252MJGB	ACTIVE	CDIP	JG	8	1	TBD	A42 SNPB	Level-NC-NC-NC
TLC2252MUB	ACTIVE	CFP	U	10	1	TBD	A42 SNPB	Level-NC-NC-NC
TLC2252QD	ACTIVE	SOIC	D	8	75	TBD	CU NIPDAU	Level-1-220C-UNLIM
TLC2252QDR	ACTIVE	SOIC	D	8	2500	TBD	CU NIPDAU	Level-1-220C-UNLIM
TLC2254AID	ACTIVE	SOIC	D	14	50	Green (RoHS & no Sb/Br)	CU NIPDAU	Level-1-260C-UNLIM
TLC2254AIDR	ACTIVE	SOIC	D	14	2500	Green (RoHS & no Sb/Br)	CU NIPDAU	Level-1-260C-UNLIM
TLC2254AIN	ACTIVE	PDIP	N	14	25	Pb-Free (RoHS)	CU NIPD	Level-NC-NC-NC
TLC2254AINE4	ACTIVE	PDIP	N	14	25	Pb-Free (RoHS)	CU NIPD	Level-NC-NC-NC
TLC2254AIPW	ACTIVE	TSSOP	PW	14	90	TBD	CU NIPDAU	Level-1-220C-UNLIM
TLC2254AIPWLE	OBSOLETE	TSSOP	PW	14		TBD	Call TI	Call TI
TLC2254AIPWR	ACTIVE	TSSOP	PW	14	2000	TBD	CU NIPDAU	Level-1-220C-UNLIM
TLC2254AMFKB	ACTIVE	LCCC	FK	20	1	TBD	POST-PLATE	Level-NC-NC-NC
TLC2254AMJB	ACTIVE	CDIP	J	14	1	TBD	A42 SNPB	Level-NC-NC-NC
TLC2254AMWB	ACTIVE	CFP	W	14	1	TBD	A42 SNPB	Level-NC-NC-NC
TLC2254AQD	ACTIVE	SOIC	D	14	50	TBD	CU NIPDAU	Level-1-220C-UNLIM
TLC2254AQDR	ACTIVE	SOIC	D	14	2500	TBD	CU NIPDAU	Level-1-220C-UNLIM
TLC2254CD	ACTIVE	SOIC	D	14	50	Green (RoHS & no Sb/Br)	CU NIPDAU	Level-1-260C-UNLIM
TLC2254CDR	ACTIVE	SOIC	D	14	2500	Green (RoHS & no Sb/Br)	CU NIPDAU	Level-1-260C-UNLIM
TLC2254CN	ACTIVE	PDIP	N	14	25	Pb-Free (RoHS)	CU NIPD	Level-NC-NC-NC
TLC2254CNE4	ACTIVE	PDIP	N	14	25	Pb-Free (RoHS)	CU NIPD	Level-NC-NC-NC
TLC2254CPW	ACTIVE	TSSOP	PW	14	90	TBD	CU NIPDAU	Level-1-220C-UNLIM
TLC2254CPWLE	OBSOLETE	TSSOP	PW	14		TBD	Call TI	Call TI
TLC2254CPWR	ACTIVE	TSSOP	PW	14	2000	TBD	CU NIPDAU	Level-1-220C-UNLIM
TLC2254ID	ACTIVE	SOIC	D	14	50	Green (RoHS & no Sb/Br)	CU NIPDAU	Level-1-260C-UNLIM
TLC2254IDR	ACTIVE	SOIC	D	14	2500	Green (RoHS & no Sb/Br)	CU NIPDAU	Level-1-260C-UNLIM
TLC2254IN	ACTIVE	PDIP	N	14	25	Pb-Free (RoHS)	CU NIPD	Level-NC-NC-NC

Orderable Device	Status ⁽¹⁾	Package Type	Package Drawing	Pins	Package Qty	Eco Plan ⁽²⁾	Lead/Ball Finish	MSL Peak Temp ⁽³⁾
TLC2254INE4	ACTIVE	PDIP	N	14	25	Pb-Free (RoHS)	CU NIPD	Level-NC-NC-NC
TLC2254IPW	ACTIVE	TSSOP	PW	14	90	TBD	CU NIPDAU	Level-1-220C-UNLIM
TLC2254IPWR	ACTIVE	TSSOP	PW	14	2000	TBD	CU NIPDAU	Level-1-220C-UNLIM
TLC2254MFKB	ACTIVE	LCCC	FK	20	1	TBD	POST-PLATE	Level-NC-NC-NC
TLC2254MJB	ACTIVE	CDIP	J	14	1	TBD	A42 SNPB	Level-NC-NC-NC
TLC2254MWB	ACTIVE	CFP	W	14	1	TBD	A42 SNPB	Level-NC-NC-NC
TLC2254QD	ACTIVE	SOIC	D	14	50	TBD	CU NIPDAU	Level-1-220C-UNLIM
TLC2254QDR	ACTIVE	SOIC	D	14	2500	TBD	CU NIPDAU	Level-1-220C-UNLIM

⁽¹⁾ The marketing status values are defined as follows:

ACTIVE: Product device recommended for new designs.

LIFEBUY: TI has announced that the device will be discontinued, and a lifetime-buy period is in effect.

NRND: Not recommended for new designs. Device is in production to support existing customers, but TI does not recommend using this part in a new design.

PREVIEW: Device has been announced but is not in production. Samples may or may not be available.

OBSOLETE: TI has discontinued the production of the device.

⁽²⁾ Eco Plan - The planned eco-friendly classification: Pb-Free (RoHS) or Green (RoHS & no Sb/Br) - please check <http://www.ti.com/productcontent> for the latest availability information and additional product content details.

TBD: The Pb-Free/Green conversion plan has not been defined.

Pb-Free (RoHS): TI's terms "Lead-Free" or "Pb-Free" mean semiconductor products that are compatible with the current RoHS requirements for all 6 substances, including the requirement that lead not exceed 0.1% by weight in homogeneous materials. Where designed to be soldered at high temperatures, TI Pb-Free products are suitable for use in specified lead-free processes.

Green (RoHS & no Sb/Br): TI defines "Green" to mean Pb-Free (RoHS compatible), and free of Bromine (Br) and Antimony (Sb) based flame retardants (Br or Sb do not exceed 0.1% by weight in homogeneous material)

⁽³⁾ MSL, Peak Temp. -- The Moisture Sensitivity Level rating according to the JEDEC industry standard classifications, and peak solder temperature.

Important Information and Disclaimer:The information provided on this page represents TI's knowledge and belief as of the date that it is provided. TI bases its knowledge and belief on information provided by third parties, and makes no representation or warranty as to the accuracy of such information. Efforts are underway to better integrate information from third parties. TI has taken and continues to take reasonable steps to provide representative and accurate information but may not have conducted destructive testing or chemical analysis on incoming materials and chemicals. TI and TI suppliers consider certain information to be proprietary, and thus CAS numbers and other limited information may not be available for release.

In no event shall TI's liability arising out of such information exceed the total purchase price of the TI part(s) at issue in this document sold by TI to Customer on an annual basis.

JG (R-GDIP-T8)

CERAMIC DUAL-IN-LINE



- NOTES: A. All linear dimensions are in inches (millimeters).
 B. This drawing is subject to change without notice.
 C. This package can be hermetically sealed with a ceramic lid using glass frit.
 D. Index point is provided on cap for terminal identification.
 E. Falls within MIL STD 1835 GDIP1-T8

J (R-GDIP-T**)

14 LEADS SHOWN

CERAMIC DUAL IN-LINE PACKAGE



DIM \ PINS **	14	16	18	20
A	0.300 (7,62) BSC	0.300 (7,62) BSC	0.300 (7,62) BSC	0.300 (7,62) BSC
B MAX	0.785 (19,94)	.840 (21,34)	0.960 (24,38)	1.060 (26,92)
B MIN	—	—	—	—
C MAX	0.300 (7,62)	0.300 (7,62)	0.310 (7,87)	0.300 (7,62)
C MIN	0.245 (6,22)	0.245 (6,22)	0.220 (5,59)	0.245 (6,22)



4040083/F 03/03

- NOTES:
- All linear dimensions are in inches (millimeters).
 - This drawing is subject to change without notice.
 - This package is hermetically sealed with a ceramic lid using glass frit.
 - Index point is provided on cap for terminal identification only on press ceramic glass frit seal only.
 - Falls within MIL STD 1835 GDIP1-T14, GDIP1-T16, GDIP1-T18 and GDIP1-T20.

U (S-GDFP-F10)

CERAMIC DUAL FLATPACK

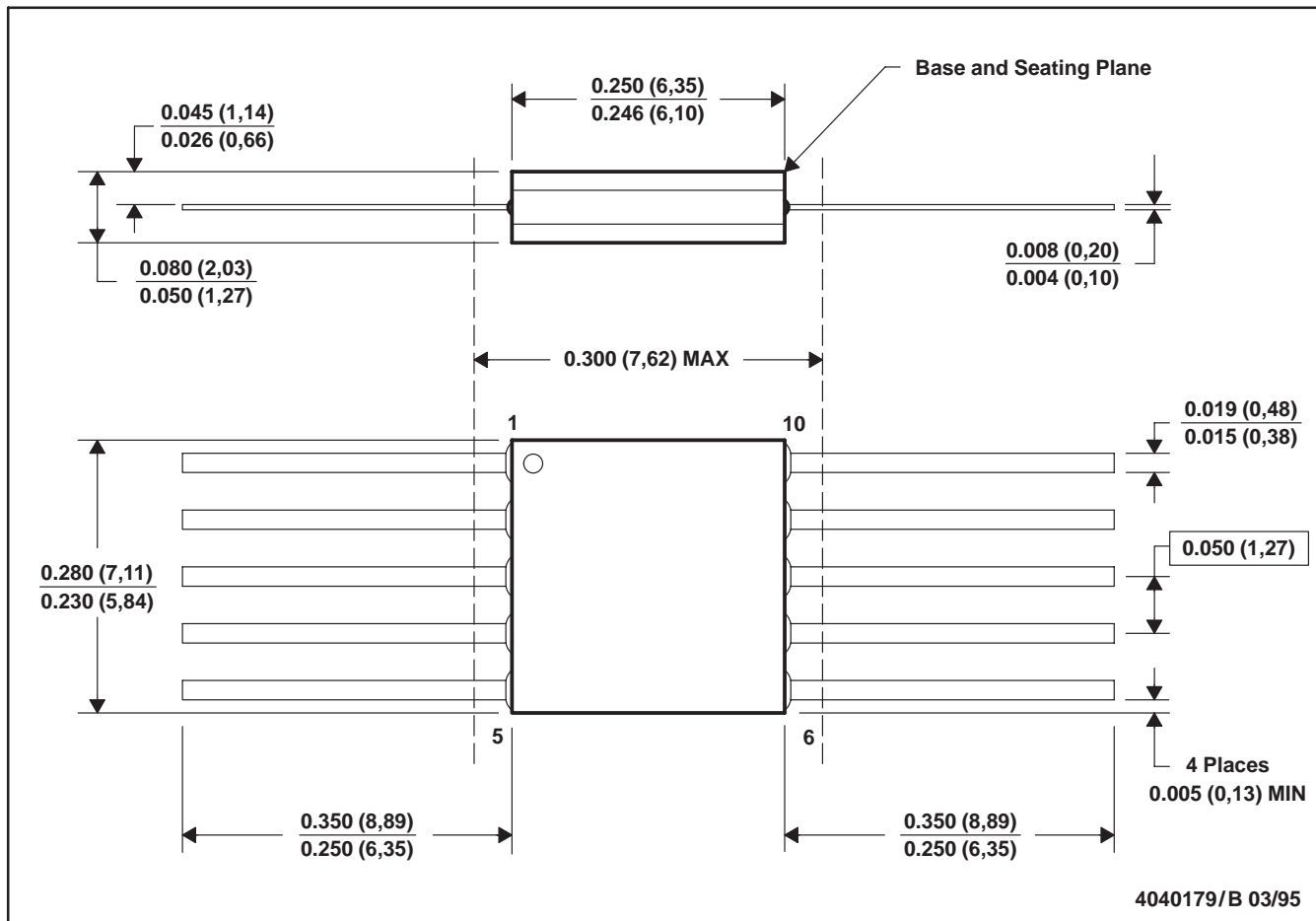

- NOTES:
- A. All linear dimensions are in inches (millimeters).
 - B. This drawing is subject to change without notice.
 - C. This package can be hermetically sealed with a ceramic lid using glass frit.
 - D. Index point is provided on cap for terminal identification only.
 - E. Falls within MIL STD 1835 GDFP1-F10 and JEDEC MO-092AA

W (R-GDFP-F14)

CERAMIC DUAL FLATPACK

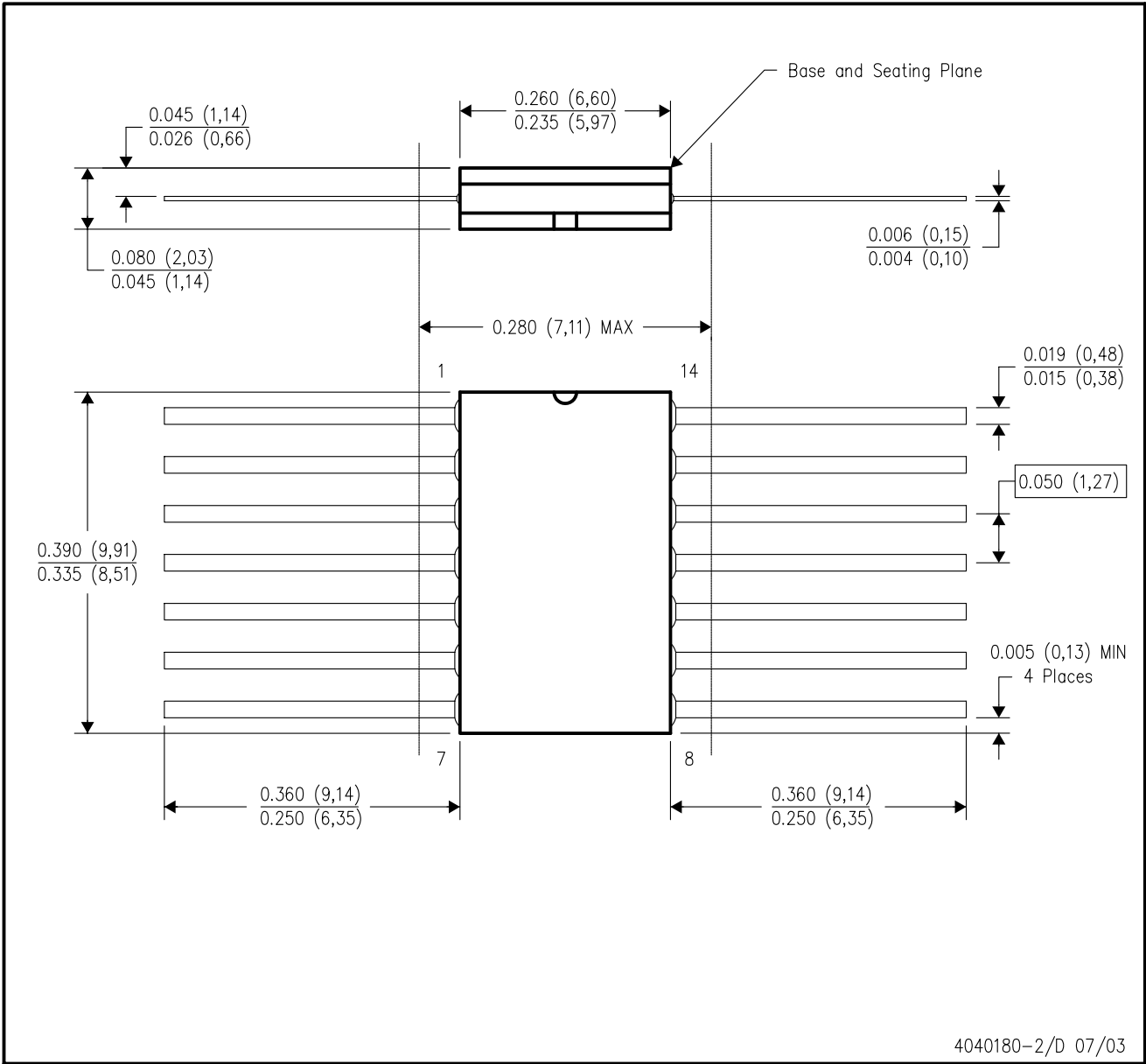

- NOTES:
- A. All linear dimensions are in inches (millimeters).
 - B. This drawing is subject to change without notice.
 - C. This package can be hermetically sealed with a ceramic lid using glass frit.
 - D. Index point is provided on cap for terminal identification only.
 - E. Falls within MIL STD 1835 GDFP1-F14 and JEDEC MO-092AB

FK (S-CQCC-N**)

LEADLESS CERAMIC CHIP CARRIER

28 TERMINAL SHOWN



4040140/D 10/96

- NOTES:
- A. All linear dimensions are in inches (millimeters).
 - B. This drawing is subject to change without notice.
 - C. This package can be hermetically sealed with a metal lid.
 - D. The terminals are gold plated.
 - E. Falls within JEDEC MS-004

P (R-PDIP-T8)

PLASTIC DUAL-IN-LINE



- NOTES: A. All linear dimensions are in inches (millimeters).
 B. This drawing is subject to change without notice.
 C. Falls within JEDEC MS-001

For the latest package information, go to http://www.ti.com/sc/docs/package/pkg_info.htm

N (R-PDIP-T**)

PLASTIC DUAL-IN-LINE PACKAGE

16 PINS SHOWN



- NOTES:
- A. All linear dimensions are in inches (millimeters).
 - B. This drawing is subject to change without notice.
 - Falls within JEDEC MS-001, except 18 and 20 pin minimum body length (Dim A).
 - The 20 pin end lead shoulder width is a vendor option, either half or full width.

D (R-PDSO-G14)

PLASTIC SMALL-OUTLINE PACKAGE

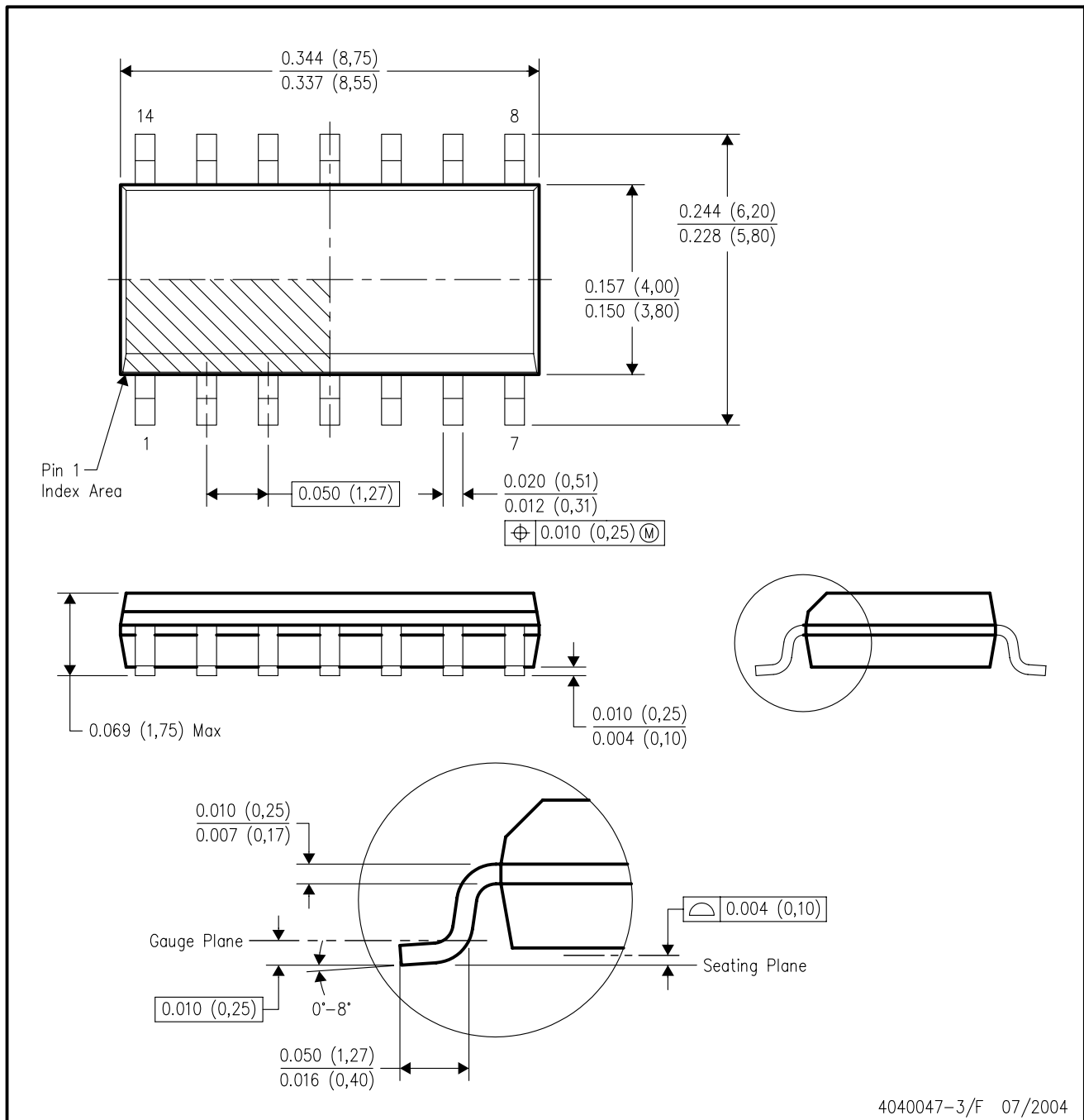

- NOTES:
- A. All linear dimensions are in inches (millimeters).
 - B. This drawing is subject to change without notice.
 - C. Body dimensions do not include mold flash or protrusion not to exceed 0.006 (0,15).
 - D. Falls within JEDEC MS-012 variation AB.

D (R-PDSO-G8)

PLASTIC SMALL-OUTLINE PACKAGE

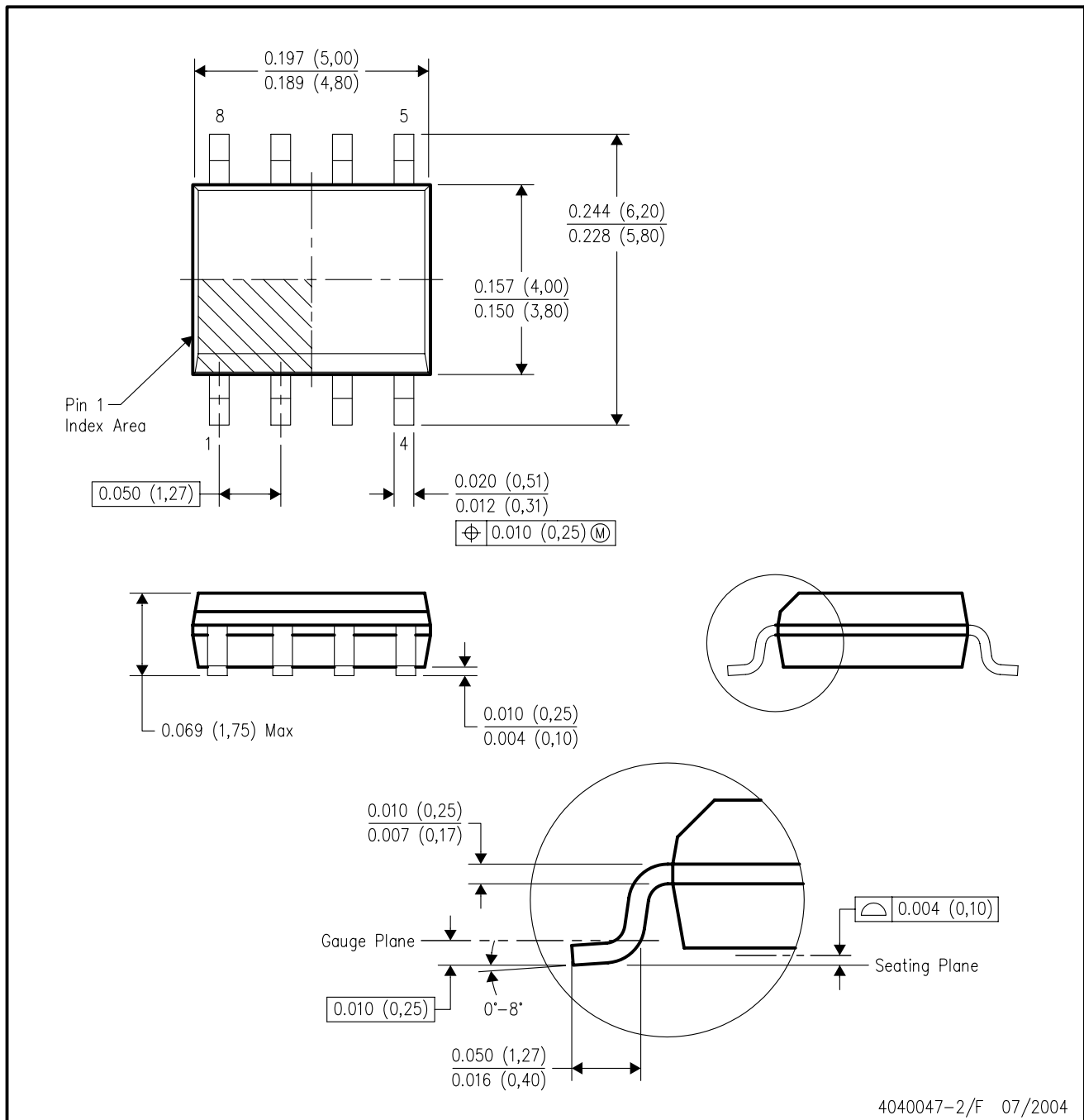

- NOTES:
- A. All linear dimensions are in inches (millimeters).
 - B. This drawing is subject to change without notice.
 - C. Body dimensions do not include mold flash or protrusion not to exceed 0.006 (0,15).
 - D. Falls within JEDEC MS-012 variation AA.

PW (R-PDSO-G**)

PLASTIC SMALL-OUTLINE PACKAGE

14 PINS SHOWN

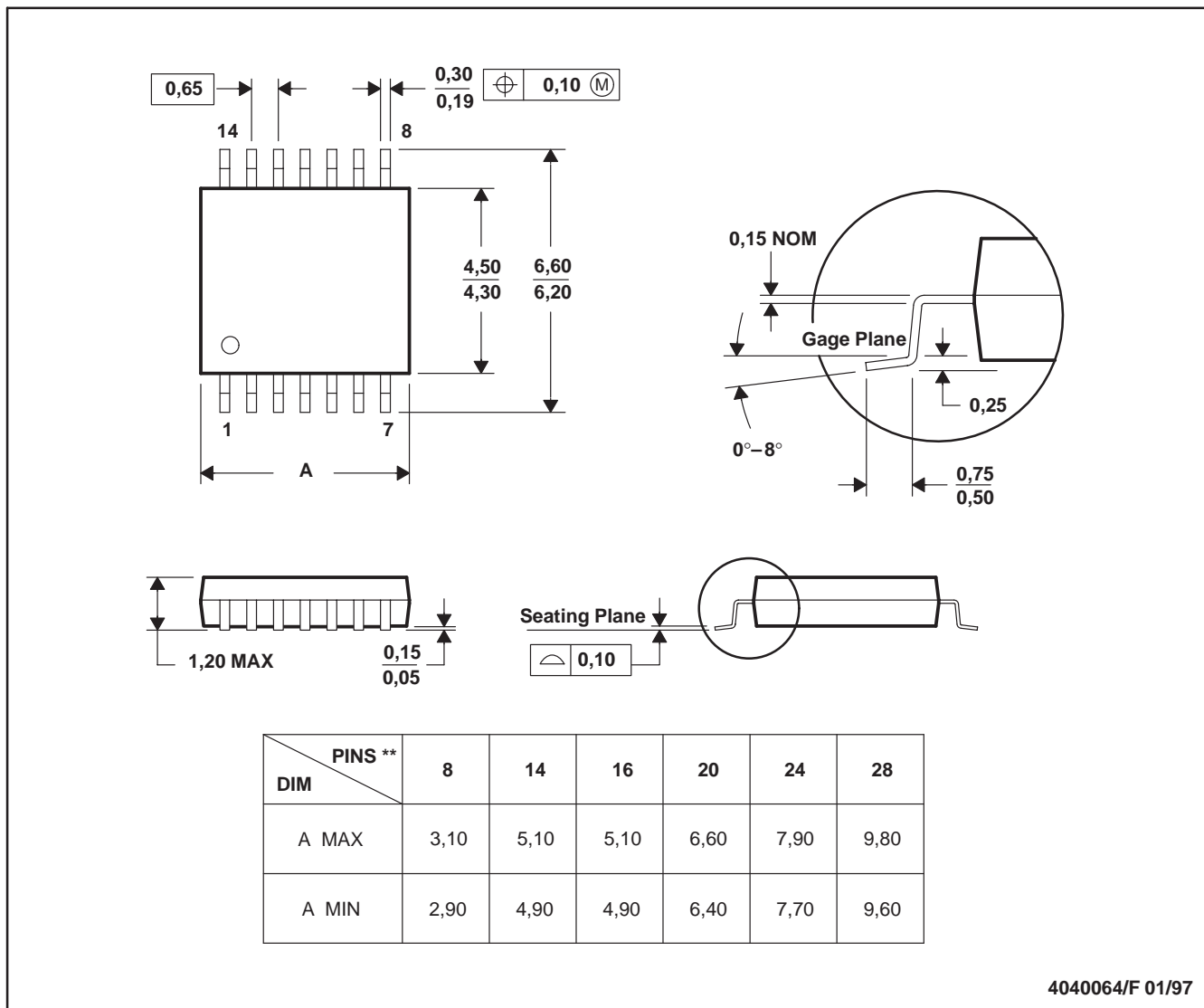

4040064/F 01/97

- NOTES: A. All linear dimensions are in millimeters.
 B. This drawing is subject to change without notice.
 C. Body dimensions do not include mold flash or protrusion not to exceed 0,15.
 D. Falls within JEDEC MO-153

IMPORTANT NOTICE

Texas Instruments Incorporated and its subsidiaries (TI) reserve the right to make corrections, modifications, enhancements, improvements, and other changes to its products and services at any time and to discontinue any product or service without notice. Customers should obtain the latest relevant information before placing orders and should verify that such information is current and complete. All products are sold subject to TI's terms and conditions of sale supplied at the time of order acknowledgment.

TI warrants performance of its hardware products to the specifications applicable at the time of sale in accordance with TI's standard warranty. Testing and other quality control techniques are used to the extent TI deems necessary to support this warranty. Except where mandated by government requirements, testing of all parameters of each product is not necessarily performed.

TI assumes no liability for applications assistance or customer product design. Customers are responsible for their products and applications using TI components. To minimize the risks associated with customer products and applications, customers should provide adequate design and operating safeguards.

TI does not warrant or represent that any license, either express or implied, is granted under any TI patent right, copyright, mask work right, or other TI intellectual property right relating to any combination, machine, or process in which TI products or services are used. Information published by TI regarding third-party products or services does not constitute a license from TI to use such products or services or a warranty or endorsement thereof. Use of such information may require a license from a third party under the patents or other intellectual property of the third party, or a license from TI under the patents or other intellectual property of TI.

Reproduction of information in TI data books or data sheets is permissible only if reproduction is without alteration and is accompanied by all associated warranties, conditions, limitations, and notices. Reproduction of this information with alteration is an unfair and deceptive business practice. TI is not responsible or liable for such altered documentation.

Resale of TI products or services with statements different from or beyond the parameters stated by TI for that product or service voids all express and any implied warranties for the associated TI product or service and is an unfair and deceptive business practice. TI is not responsible or liable for any such statements.

Following are URLs where you can obtain information on other Texas Instruments products and application solutions:

Products		Applications	
Amplifiers	amplifier.ti.com	Audio	www.ti.com/audio
Data Converters	dataconverter.ti.com	Automotive	www.ti.com/automotive
DSP	dsp.ti.com	Broadband	www.ti.com/broadband
Interface	interface.ti.com	Digital Control	www.ti.com/digitalcontrol
Logic	logic.ti.com	Military	www.ti.com/military
Power Mgmt	power.ti.com	Optical Networking	www.ti.com/opticalnetwork
Microcontrollers	microcontroller.ti.com	Security	www.ti.com/security
		Telephony	www.ti.com/telephony
		Video & Imaging	www.ti.com/video
		Wireless	www.ti.com/wireless

Mailing Address: Texas Instruments
Post Office Box 655303 Dallas, Texas 75265