

FEATURES

- Keeps track of hundredths of seconds, seconds, minutes, hours, days, date of the month, months, and years
- Adds timekeeping to any 28-pin JEDEC bytewise memory location
- Embedded lithium energy cell maintains calendar time for more than 10 years in the absence of power
- Timekeeping function is transparent to memory operation
- Month and year determine the number of days in each month; leap year compensation valid up to 2100
- Lithium energy source is electrically disconnected to retain freshness until power is applied for the first time
- Proven gas-tight socket contacts
- Full $\pm 10\%$ V_{CC} operating range
- Operating temperature range 0°C to 70°C
- Accuracy to within ± 1 minute/month @ 25°C

ORDERING INFORMATION

DS1216E 5 volt operation
 DS1216E-3 3 volt operation

DESCRIPTION

The DS1216E SmartWatch/ROM 64/256K is a 28-pin, 600 mil-wide DIP socket with a built-in CMOS timekeeper function and an embedded lithium energy source to maintain time and date. It accepts any 28-pin bytewise ROM or volatile RAM. A key feature of the SmartWatch is that the timekeeper function remains transparent to the memory device placed above. The SmartWatch monitors V_{CC} for an out-of-tolerance condition. When such a condition occurs, an internal lithium energy source is automatically switched on to prevent loss of watch data.

Using the SmartWatch saves PC board space since the combination of the SmartWatch and the mated memory device takes up no more area than the memory alone. The SmartWatch uses pins 1, 8, 10, 11,

PIN ASSIGNMENT

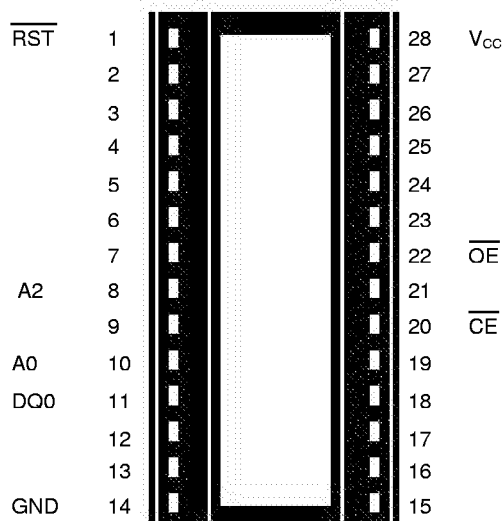

28-Pin Intelligent Socket

PIN DESCRIPTION

All pins pass through to the socket except 20.

- Pin 1 $\overline{\text{RST}}$ - Reset
- Pin 8 A2 - Address Bit 2 ($\overline{\text{READ/WRITE}}$)
- Pin 10 A0 - Address Bit 0 (Data Input)
- Pin 11 DQ0 - I/O₀ (Data Output)
- Pin 14 GND - Ground
- Pin 20 $\overline{\text{CE}}$ - Conditioned Chip Enable
- Pin 22 $\overline{\text{OE}}$ - Output Enable
- Pin 28 V_{CC} - Power Supply Input

20, and 22 for timekeeper control. All pins pass through to the socket receptacle except for pin 20 (\overline{CE}), which is inhibited during the transfer of time information.

The SmartWatch provides timekeeping information including hundredths of seconds, seconds, minutes, hours, days, date, month, and year information. The date at the end of the month is automatically adjusted for months with fewer than 31 days, including correction for leap years. The SmartWatch operates in either 24-hour or 12-hour format with an AM/PM indicator.

OPERATION

A highly structured sequence of 64 cycles is used to gain access to time information and temporarily disconnects the mated memory from the system bus. Information transfer into and out of the SmartWatch is achieved by using address bits A0 and A2, control signals \overline{OE} and \overline{CE} , and data I/O line DQ0. All SmartWatch data transfers are accomplished by executing read cycles to the mated memory address space. Write and read functions are determined by the level of address bit A2. When address bit A2 is low, a write cycle is enabled and data must be input on address bit A0. When address bit A2 is high, a read cycle is enabled and data is output on data I/O line DQ0. Either control signal (\overline{OE} or \overline{CE}) must transition low to begin and high to end memory cycles that are directed to the SmartWatch. However, both control signals must be in an active state during a memory cycle.

Communication with the SmartWatch is established by pattern recognition of a serial bit stream of 64 bits which must be matched by executing 64 consecutive write cycles, placing address bit A2 low with the proper data on address bit A0. The 64 write cycles are used only to gain access to the SmartWatch. Prior to executing the first of 64 write cycles, a read cycle should be executed by holding A2 high. The read cycle will reset the comparison register pointer within the SmartWatch, ensuring the pattern recognition starts with the first bit of the sequence. When the first write cycle is executed, it is compared to bit 0 of the 64-bit comparison register. If a match is found, the pointer increments to the next location of the comparison register and awaits the next write cycle. If a match is not found, the pointer does not advance and all subsequent write cycles are ignored. If a read cycle occurs at any time during pattern recognition, the present sequence is aborted and the comparison register pointer is reset. Pattern recognition continues for a total of 64 write cycles as described above, until all the bits in the comparison register have been matched (this bit pattern is shown in Figure 1). With a correct match for 64 bits, the SmartWatch is enabled and data transfer to or from the timekeeping registers may proceed. The next 64 cycles will cause the SmartWatch to either receive data on Data In (A0) or transmit data on Data Out (DQ0), depending on the level of $\overline{READ/WRITE}$ (A2). Cycles to other locations outside the memory block can be interleaved with \overline{CE} and \overline{OE} cycles without interrupting the pattern recognition sequence or data transfer sequence to the SmartWatch.

An unconditional reset to the SmartWatch occurs by either bringing A14 (\overline{RESET}) low if enabled, or on power-up. The \overline{RESET} can occur during pattern recognition or while accessing the SmartWatch registers. \overline{RESET} causes access to abort and forces the comparison register pointer back to bit 0 without changing registers.

NONVOLATILE CONTROLLER OPERATION

The DS1216E SmartWatch performs circuit functions required to make the timekeeping function nonvolatile. First, a switch is provided to direct power from the battery or V_{CC} supply, depending on which voltage is greater. The second function provides power–fail detection. Power–fail detection typically occurs at V_{TP} . Finally, the nonvolatile controller protects the SmartWatch register contents by ignoring any inputs after power–fail detection has occurred. Power–fail detection also has the same effect on data transfer as the RESET input.

FRESHNESS SEAL

Each DS1216E is shipped from Dallas Semiconductor with its lithium energy source disconnected, insuring full energy capacity. When V_{CC} is first applied at a level greater than V_{TP} , the lithium energy source is enabled for battery backup operation.

SMARTWATCH REGISTER INFORMATION

The SmartWatch information is contained in eight registers of 8 bits each which are sequentially accessed one bit at a time after the 64–bit pattern recognition sequence has been completed. When updating the SmartWatch registers, each must be handled in groups of 8 bits. Writing and reading individual bits within a register could produce erroneous results. These read/write registers are defined in Figure 2.

Data contained in the SmartWatch registers is in binary coded decimal format (BCD). Reading and writing the registers is always accomplished by stepping through all eight registers, starting with bit 0 of register 0 and ending with bit 7 of register 7.

AM–PM/12/24 MODE

Bit 7 of the hours register is defined as the 12– or 24–hour mode select bit. When high, the 12–hour mode is selected. In the 12–hour mode, bit 5 is the AM/PM bit with logic high being PM. In the 24–hour mode, bit 5 is the second 10–hour bit (20–23 hours).

OSCILLATOR AND RESET BITS

Bits 4 and 5 of the day register are used to control the RESET and oscillator functions. Bit 4 controls the RESET (pin 1). When the RESET bit is set to logic 1, the RESET input pin is ignored. When the RESET bit is set to logic 0, a low input on the RESET pin will cause the SmartWatch to abort data transfer without changing data in the watch registers. Bit 5 controls the oscillator. When set to logic 1, the oscillator is turned off. When set to logic 0, the oscillator turns on and the watch becomes operational. Both bits are set to logic 1 when shipped from the factory.

ZERO BITS

Registers 1,2,3,4,5, and 6 contain one or more bits which will always read logic 0. When writing these locations, either logic 1 or 0 is acceptable.

ADDITIONAL INFORMATION

Please see Application Notes 4 and 52 for information regarding optional modifications and utilization of the Phantom Clock contained within the SmartWatch.

SMARTWATCH COMPARISON REGISTER DEFINITION Figure 1

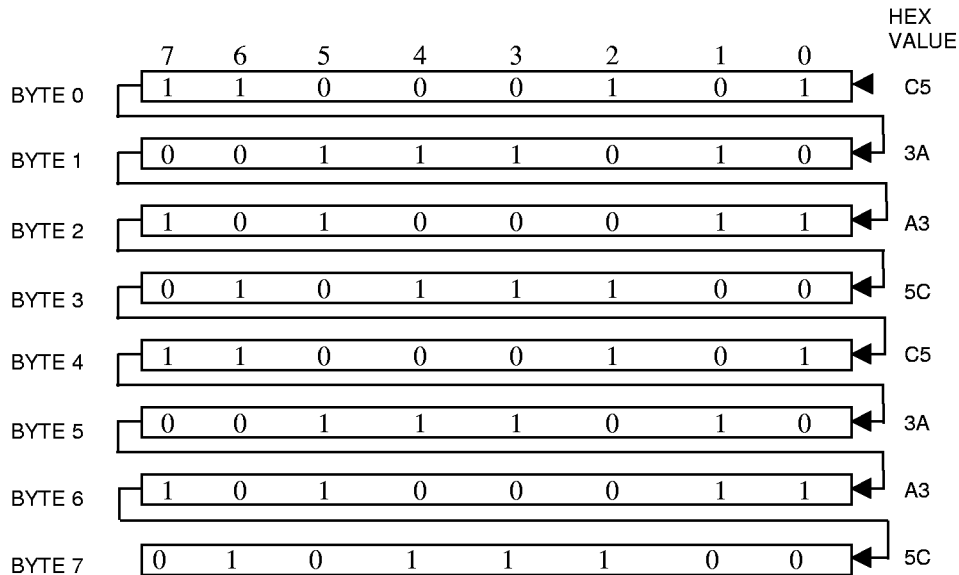

NOTE:

The pattern recognition sequence in Hex is C5, 3A, 5C, C5, 3A, A3, 5C. The odds of this pattern accidentally occurring and causing inadvertent entry to the SmartWatch is less than 1 in 10^{19} . This pattern is sent to the SmartWatch LSB to MSB.

SMARTWATCH REGISTER DEFINITION Figure 2

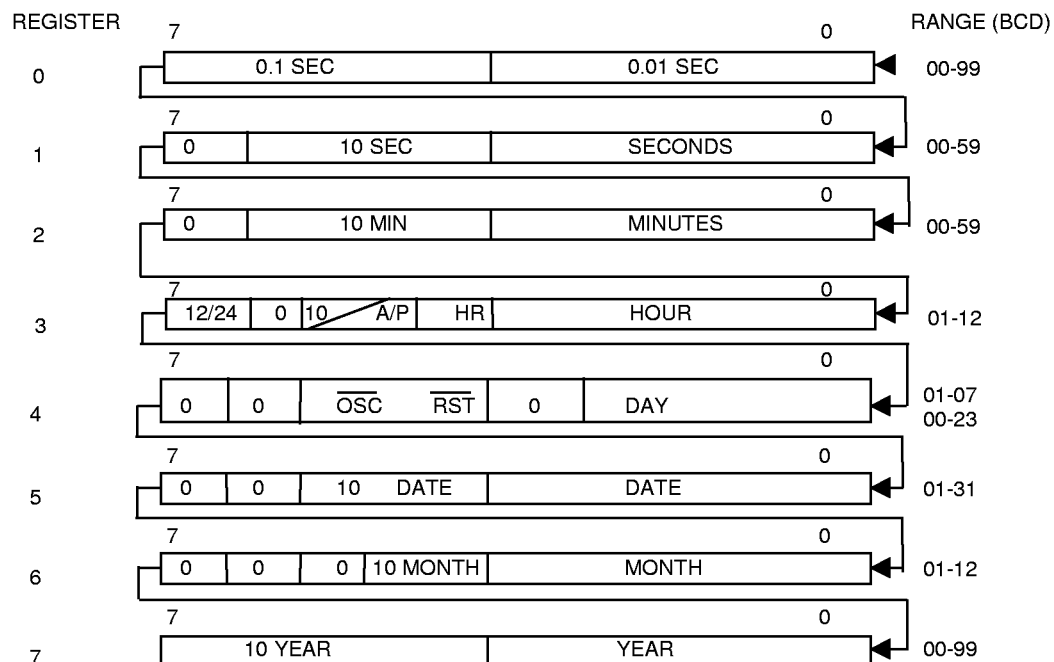

ABSOLUTE MAXIMUM RATINGS*

Voltage on Any Pin Relative to Ground	-0.3V to +7.0V
Operating Temperature	0°C to 70°C
Storage Temperature	-40°C to +70°C
Soldering Temperature	260°C for 10 seconds (See Note 11)

* This is a stress rating only and functional operation of the device at these or any other conditions above those indicated in the operation sections of this specification is not implied. Exposure to absolute maximum rating conditions for extended periods of time may affect reliability.

RECOMMENDED DC OPERATING CONDITIONS (0°C to 70°C)

PARAMETER	SYMBOL	MIN	TYP	MAX	UNITS	NOTES
Pin 28L Supply Voltage	V _{CC}	4.5	5.0	5.5	V	1, 3
Logic 1	V _{IH}	2.2		V _{CC} + 0.3	V	1, 6
Logic 0	V _{IL}	-0.3		+0.8	V	1, 6

DC ELECTRICAL CHARACTERISTICS (0°C to 70°C; V_{CC} = 4.5 to 5.5V)

PARAMETER	SYMBOL	MIN	TYP	MAX	UNITS	NOTES
Pin 28L Supply	I _{CCI}			5	mA	3, 4
Input Leakage	I _{IL}	-1.0		+1.0	μA	4,6,10
Output @ 2.4V	I _{OH}	-1.0			mA	2
Output @ 0.4V	I _{OL}			4.0	mA	2
Write Protection Voltage	V _{TP}	4.25		4.5	V	

CAPACITANCE (t_A = 25°C)

PARAMETER	SYMBOL	MIN	TYP	MAX	UNITS	NOTES
Input Capacitance	C _{IN}			5	pF	
Output Capacitance	C _{OUT}			7	pF	

AC ELECTRICAL CHARACTERISTICS(0°C to 70°C; $V_{CC} = 5V \pm 10\%$)

PARAMETER	SYMBOL	MIN	TYP	MAX	UNITS	NOTES
Read Cycle Time	t_{RC}	250			ns	
\overline{CE} Access Time	t_{CO}			200	ns	
\overline{OE} Access Time	t_{OE}			100	ns	
\overline{CE} To Output Low Z	t_{COE}	10			ns	
\overline{OE} To Output Low Z	t_{OEE}	10			ns	
\overline{CE} To Output High Z	t_{OD}			100	ns	
\overline{OE} To Output High Z	t_{ODO}			100	ns	
Address Setup Time	t_{AS}	20			ns	9
Address Hold Time	t_{AH}			10	ns	8
Read Recovery	t_{RR}	50			ns	7
Write Cycle Time	t_{WC}	250			ns	
\overline{CE} Pulse Width	t_{CW}	170			ns	
\overline{OE} Pulse Width	t_{OW}	170			ns	
Write Recovery	t_{WR}	50			ns	7
Data Setup Time	t_{DS}	100			ns	8
Data Hold Time	t_{DH}	0			ns	8
\overline{RESET} Pulse Width	t_{RST}	200			ns	
\overline{CE} Propagation Delay	t_{PD}	5	10	20	ns	2,5
\overline{CE} High to Power-Fail	t_{PF}			0	ns	

(0°C to 70°C; $V_{CC} < 4.5V$)

Recovery at Power-Up	t_{REC}			2	ms	
V_{CC} Slew Rate 4.5 – 3V	t_F	0			μs	

TIMING DIAGRAM: READ CYCLE

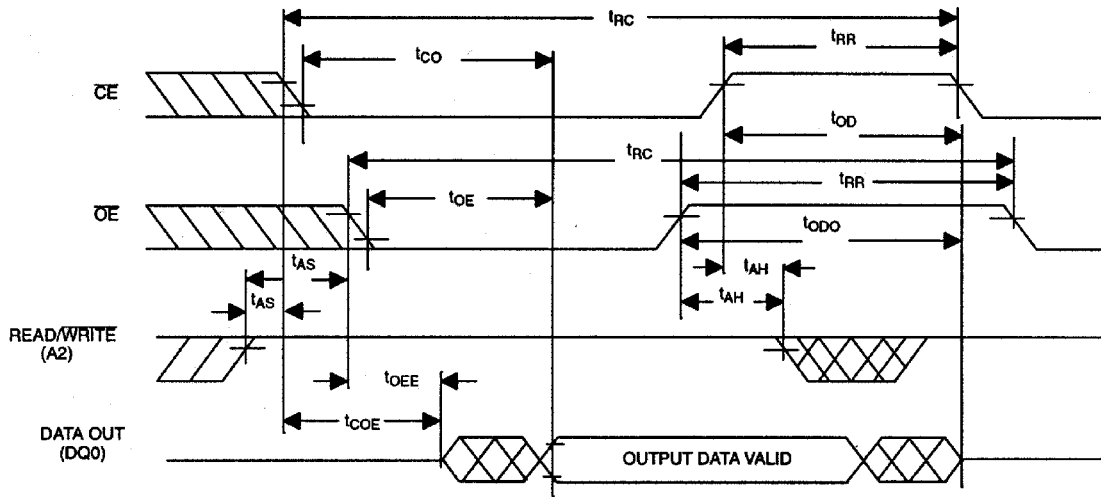

TIMING DIAGRAM: WRITE CYCLE

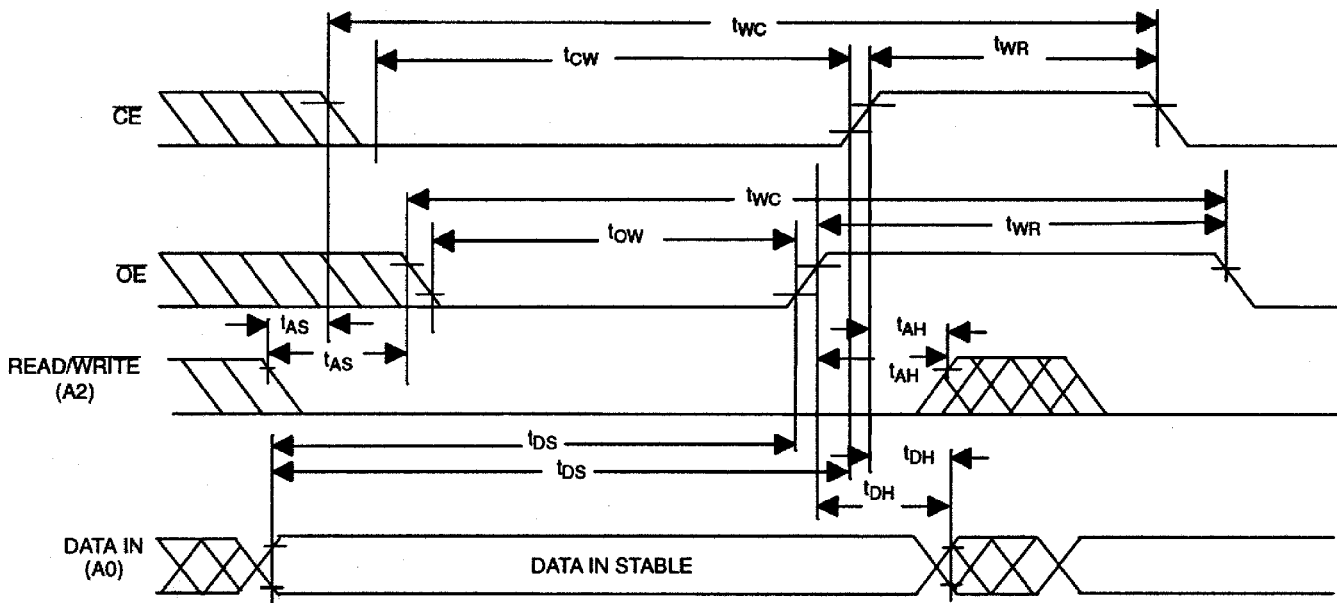

TIMING DIAGRAM: POWER-DOWN

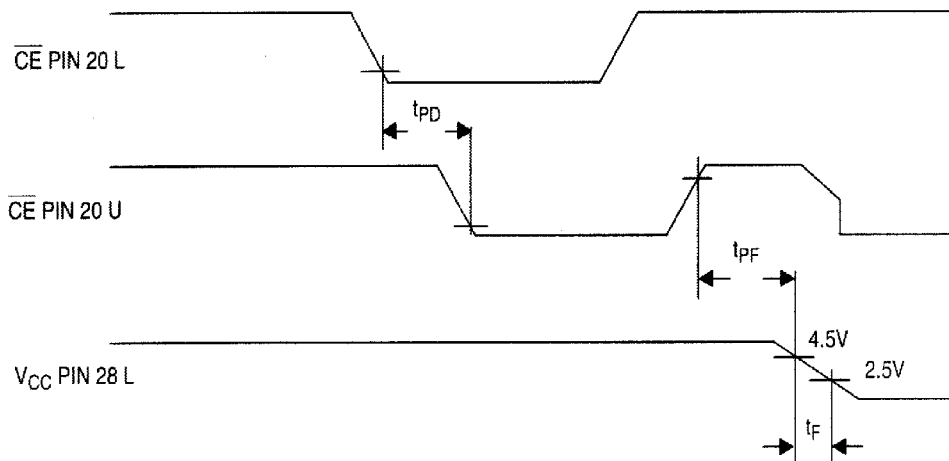

TIMING DIAGRAM: POWER-UP

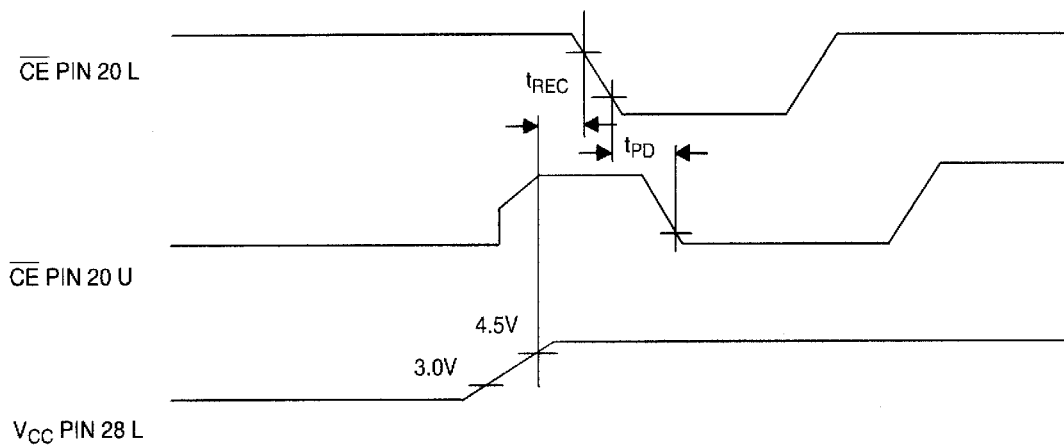

TIMING DIAGRAM: RESET FOR SMARTWATCH

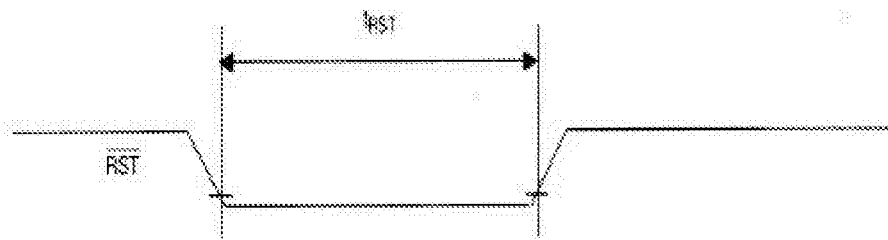

WARNING:

Under no circumstances are negative undershoots, of any amplitude, allowed when device is in battery backup mode. Water washing for flux removal will discharge internal lithium source because exposed voltage pins are present.

NOTES:

1. All voltages are referenced to ground.
2. Measured with a load as shown in Figure 3.
3. Pin locations are designated “U” when a parameter definition refers to the socket receptacle and “L” when a parameter definition refers to the socket pin.
4. No memory inserted in the socket.
5. Input pulse rise and fall times equal 10 ns.
6. Applies to Pins 1L, 8L, 10L, 20L and 22L.
7. t_{WR} and t_{RR} are functions of the latter occurring edge of \overline{OE} or \overline{CE} .
8. t_{AS} , t_{DS} and t_{DS} are functions of the first occurring edge of \overline{OE} or \overline{CE} .
9. t_{AS} , is a function of the latter occurring edge of \overline{OE} or \overline{CE} .
10. \overline{RST} (Pin 1) has an internal pull-up resistor.
11. SmartWatch sockets can be successfully processed through some conventional wave soldering techniques as long as temperature exposure to the lithium energy source contained within does not exceed +85°C. However, post solder cleaning with water washing techniques is not permissible. Discharge to the lithium energy source may result, even if de-ionized water is utilized. It is equally imperative that ultrasonic vibration is not used.

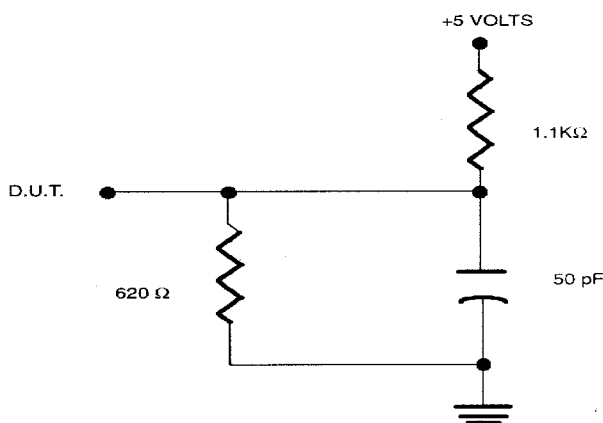
OUTPUT LOAD Figure 3

DS1216E SMARTWATCH

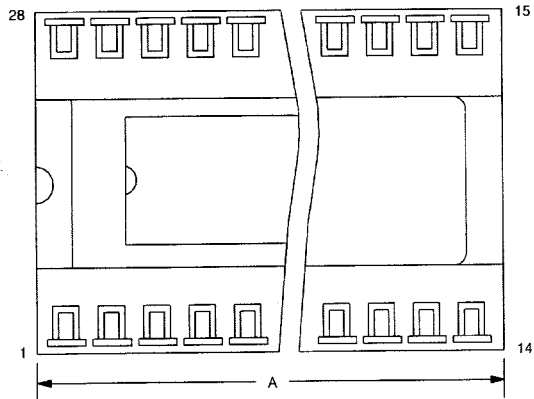

PKG DIM	28-PIN		32-PIN	
	MIN	MAX	MIN	MAX
A IN.	1.390	1.420	1.580	1.620
MM	35.31	36.07	40.13	41.14
B IN.	0.690	0.720	0.690	0.720
MM	17.53	18.29	17.53	18.29
C IN.	0.420	0.470	0.400	0.470
MM	10.67	11.94	10.16	11.94
D IN.	0.035	0.065	0.035	0.065
MM	0.89	1.65	0.89	1.65
E IN.	0.055	0.075	0.055	0.075
MM	1.39	1.90	1.39	1.90
F IN.	0.120	0.160	0.120	0.160
MM	3.04	4.06	3.04	4.06
G IN.	0.090	0.110	0.090	0.110
MM	2.29	2.79	2.29	2.79
H IN.	0.590	0.630	0.590	0.630
MM	14.99	16.00	14.99	16.00
J IN.	0.008	0.012	0.008	0.012
MM	0.20	0.30	0.20	0.30
K IN.	0.015	0.021	0.015	0.021
MM	0.38	0.53	0.38	0.53
L IN.	0.380	0.420	0.380	0.420
MM	9.65	10.67	9.65	10.67

