

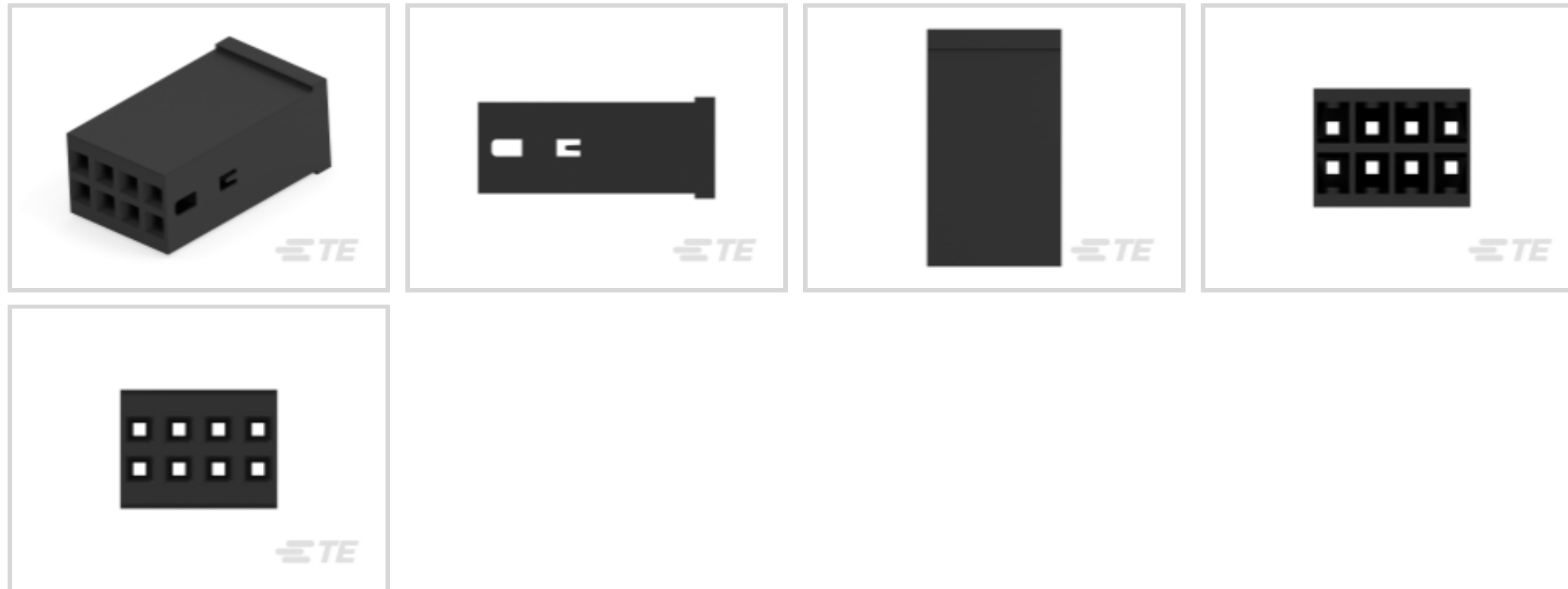

Connectors > PCB Connectors > Wire-to-Board Connectors > Wire-to-Board Connector Assemblies & Housings



Connector Product Type: **Housing**

Connector & Housing Type: **Receptacle**

Connector System: **Wire-to-Board**

Number of Positions: **8**

Centerline (Pitch): **2.54 mm [.1 in]**

Features

Product Type Features

Connector Product Type	Housing
Connector & Housing Type	Receptacle
Connector System	Wire-to-Board
Connector & Contact Terminates To	Wire & Cable

Configuration Features

Number of Positions	8
Number of Rows	2

Electrical Characteristics

Termination Resistance	12 mΩ
Insulation Resistance	5000 MΩ
Dielectric Withstanding Voltage (Max)	750 V
Operating Voltage	250 VAC

Body Features

Primary Product Color	Black
-----------------------	-------



Contact Features

Contact Type	Socket
Contact Current Rating (Max)	3 A

Termination Features

Termination Method to Wire & Cable	Crimp
------------------------------------	-------

Mechanical Attachment

Mating Retention Type	Lock
Mating Retention	Without

Housing Features

Housing Entry Configuration	Both Ends Closed
Housing Material	Polyester GF
Centerline (Pitch)	2.54 mm[.1 in]

Dimensions

Connector Length	10.57 mm[.416 in]
Connector Height	7.62 mm[.3 in]
Row-to-Row Spacing	2.54 mm[.1 in]

Usage Conditions

Operating Temperature Range	-65 – 105 °C[-85 – 221 °F]
-----------------------------	----------------------------

Operation/Application

Circuit Application	Power & Signal
---------------------	----------------

Industry Standards

Glow Wire Rating	Standard Part - Not Glow Wire
Approved Standards	CSA LR7189, UL E28476
UL Flammability Rating	UL 94V-0

Packaging Features

Packaging Quantity	250
Packaging Method	Bag

Product Compliance

For compliance documentation, visit the product page on [TE.com](https://www.te.com)>

EU RoHS Directive 2011/65/EU	Compliant
------------------------------	-----------







EU ELV Directive 2000/53/EC	Compliant
China RoHS 2 Directive MIIT Order No 32, 2016	No Restricted Materials Above Threshold
EU REACH Regulation (EC) No. 1907/2006	Current ECHA Candidate List: JUNE 2023 (235) Candidate List Declared Against: JUNE 2023 (235) Does not contain REACH SVHC
Halogen Content	Not Low Halogen - contains Br or Cl > 900 ppm.
Solder Process Capability	Not applicable for solder process capability

Product Compliance Disclaimer

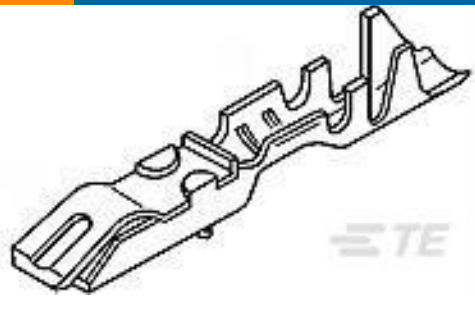
This information is provided based on reasonable inquiry of our suppliers and represents our current actual knowledge based on the information they provided. This information is subject to change. The part numbers that TE has identified as EU RoHS compliant have a maximum concentration of 0.1% by weight in homogenous materials for lead, hexavalent chromium, mercury, PBB, PBDE, DBP, BBP, DEHP, DIBP, and 0.01% for cadmium, or qualify for an exemption to these limits as defined in the Annexes of Directive 2011/65/EU (RoHS2). Finished electrical and electronic equipment products will be CE marked as required by Directive 2011/65/EU. Components may not be CE marked. Additionally, the part numbers that TE has identified as EU ELV compliant have a maximum concentration of 0.1% by weight in homogenous materials for lead, hexavalent chromium, and mercury, and 0.01% for cadmium, or qualify for an exemption to these limits as defined in the Annexes of Directive 2000/53/EC (ELV). Regarding the REACH Regulation, the information TE provides on SVHC in articles for this part number is based on the latest European Chemicals Agency (ECHA) 'Guidance on requirements for substances in articles' posted at this URL: <https://echa.europa.eu/guidance-documents/guidance-on-reach>

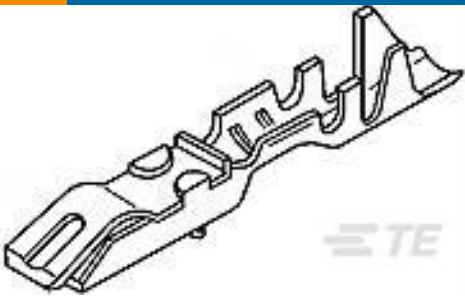
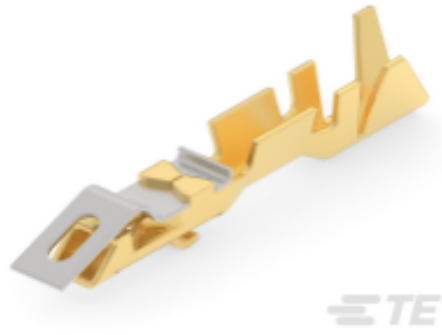
Compatible Parts

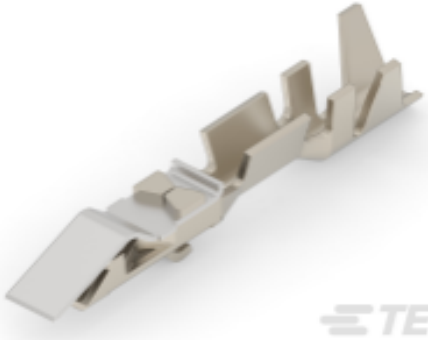
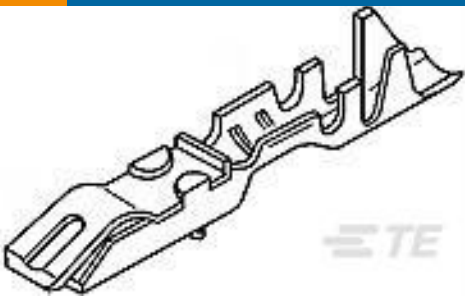
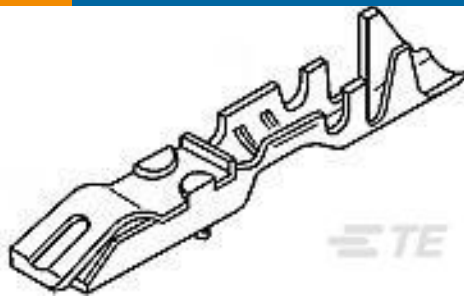
 <p>TE Part # 5-87165-2 LOCKING CLIP ASSY .025 SQ LP</p>	 <p>TE Part # 87179-1 LOCKING CLIP KEYING PLUG</p>	 <p>TE Part # 87190-1 LOCKING CLIP CONT ASSY .025 SQ</p>	 <p>TE Part # 867052-2 LOCKING CLIP CONT ASSY .025 SQ</p>
 <p>TE Part # 5-87124-2 LOCKING CLIP CONT ASSY .025 SQ</p>	 <p>TE Part # 87124-1 LOCKING CLIP CONT ASSY .025 SQ</p>	 <p>TE Part # 5-867052-1 LOCKING CLIP CONT ASSY .025 SQ</p>	 <p>TE Part # 5-87191-2 LOCKING CLIP ASSY .025 SQ LP</p>

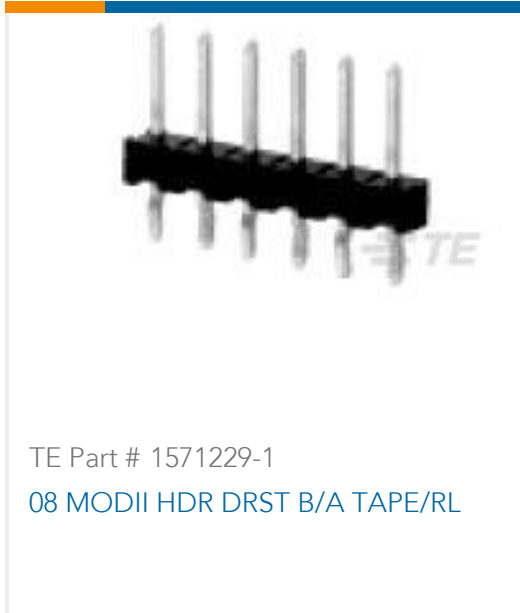

Also in the Series | AMPMODU LOCKING CLIP

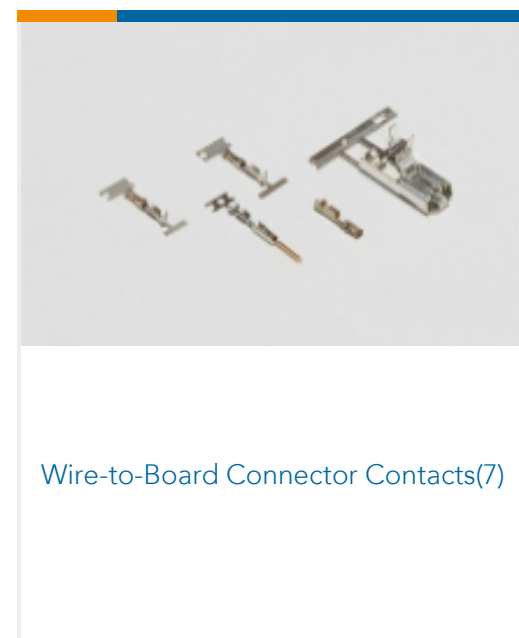
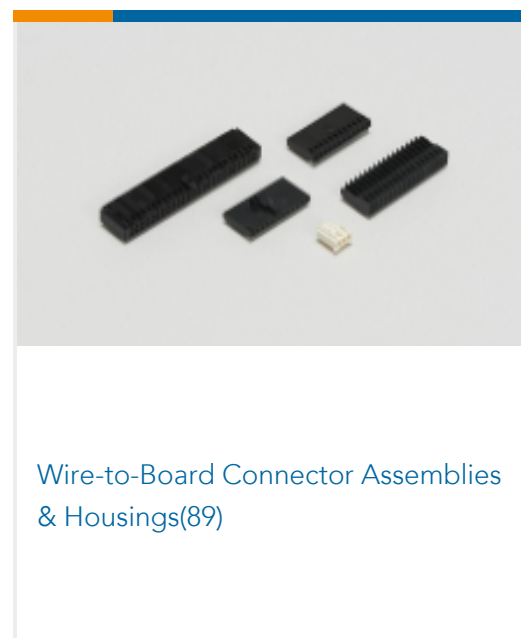
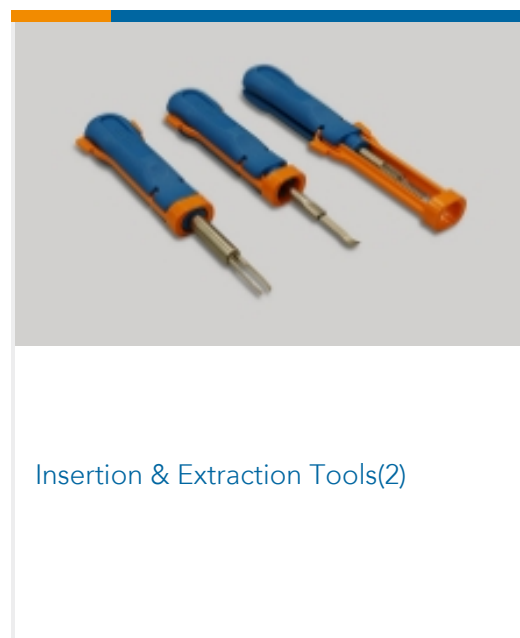

Customers Also Bought

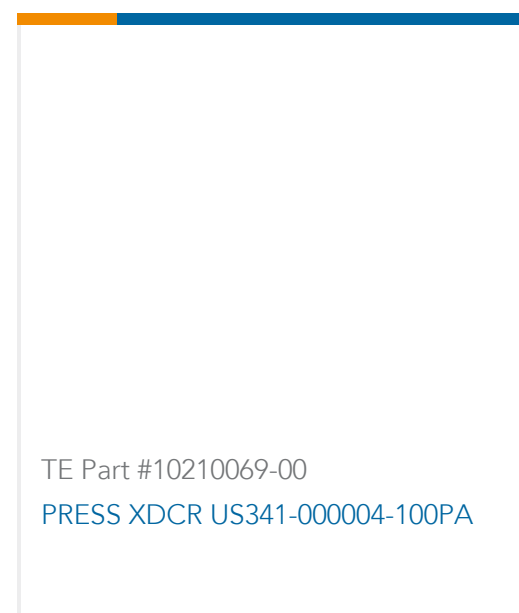
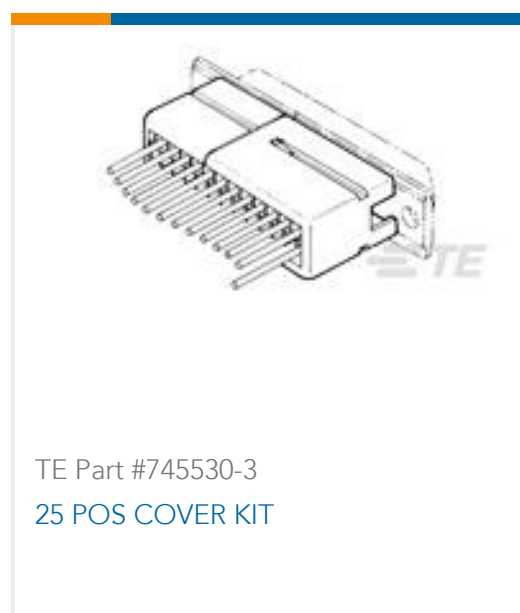



Documents

CAD Files

3D PDF

3D

Customer View Model

[ENG_CVM_CVM_1-87133-0_AB.2d_dxf.zip](#)

English

Customer View Model

[ENG_CVM_CVM_1-87133-0_AB.3d_igs.zip](#)

English

Customer View Model

[ENG_CVM_CVM_1-87133-0_AB.3d_stp.zip](#)

English

By downloading the CAD file I accept and agree to the [Terms and Conditions](#) of use.

Datasheets & Catalog Pages

[AMPMODU_INTERCONNECTION_SYSTEM_SECTION5_CONT](#)

English

Product Environmental Compliance

[Product Compliance](#)

English

[Product Compliance](#)

English

Instruction Sheets

[Instruction Sheet \(U.S.\)](#)

English

[AMPMODU Locking Clip Contacts and Housings for 0.64mm Square Posts](#)

English

Agency Approvals

[UL](#)

English