

**OPTION "M"**

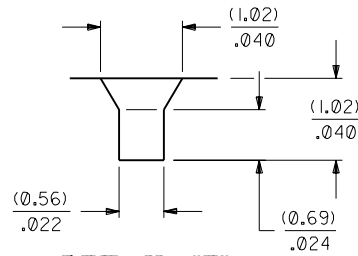

**DETAIL "F"**  
TYP.  
SCALE 20:1

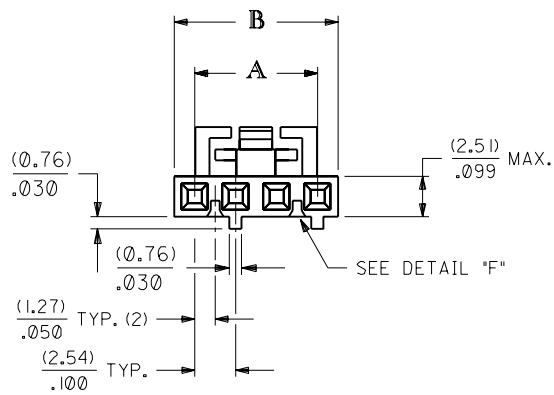
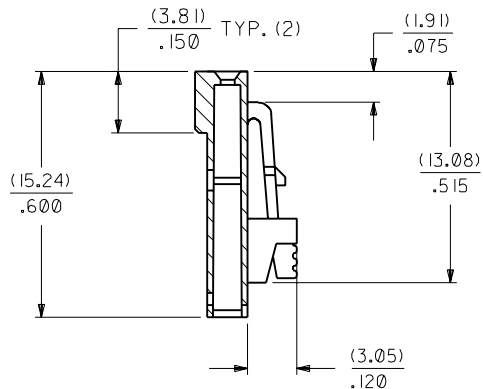
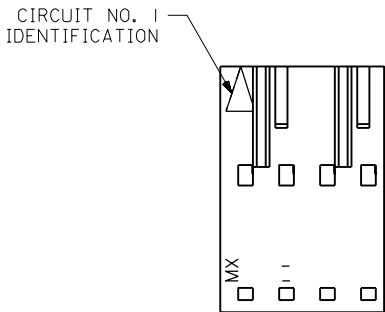

**SECTION C-C**

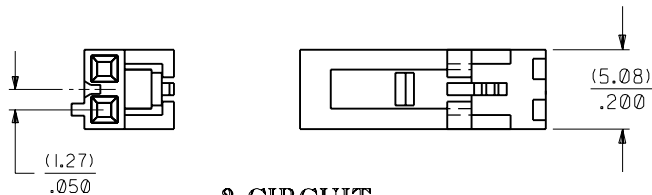
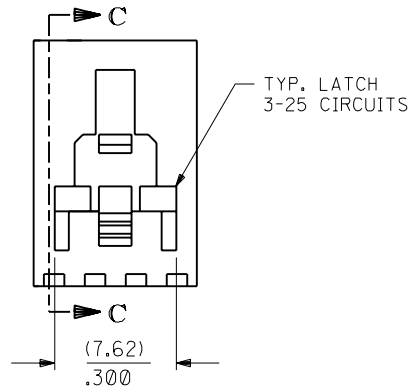

**2 CIRCUIT**

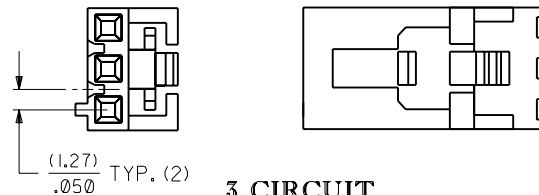

**3 CIRCUIT**

CKT. SIZE	EDP. NO.	ENG. NO.	DIM. A REF.	DIM. B REF.
2	50-57-8902	70066-0351	(2.54) .100	(5.05) .199
3	50-57-8903	70066-0352	(5.08) .200	(7.59) .299
4	50-57-8904	70066-0353	(7.62) .300	(10.13) .399
5	50-57-8905	70066-0354	(10.16) .400	(12.67) .499
6	50-57-8906	70066-0355	(12.70) .500	(15.21) .599
7	50-57-8907	70066-0356	(15.24) .600	(17.75) .699
8	50-57-8908	70066-0357	(17.78) .700	(20.29) .799
9	50-57-8909	70066-0358	(20.32) .800	(22.83) .899
10	50-57-8910	70066-0359	(22.86) .900	(25.37) .999
11	NOT TOOLED	70066-0360	(25.40) 1.000	(27.91) 1.099
12	NOT TOOLED	70066-0361	(27.94) 1.100	(30.45) 1.199
13	NOT TOOLED	70066-0362	(30.48) 1.200	(32.99) 1.299
14	NOT TOOLED	70066-0363	(33.02) 1.300	(35.53) 1.399
15	NOT TOOLED	70066-0364	(35.56) 1.400	(38.07) 1.499
16	NOT TOOLED	70066-0365	(38.10) 1.500	(40.61) 1.599
17	NOT TOOLED	70066-0366	(40.64) 1.600	(43.15) 1.699
18	NOT TOOLED	70066-0367	(43.18) 1.700	(45.69) 1.799
19	NOT TOOLED	70066-0368	(45.72) 1.800	(48.23) 1.899
20	NOT TOOLED	70066-0369	(48.26) 1.900	(50.77) 1.999
21	NOT TOOLED	70066-0370	(50.80) 2.000	(53.31) 2.099
22	NOT TOOLED	70066-0371	(53.34) 2.100	(55.85) 2.199
23	NOT TOOLED	70066-0372	(55.88) 2.200	(58.39) 2.299
24	NOT TOOLED	70066-0373	(58.42) 2.300	(60.93) 2.399
25	NOT TOOLED	70066-0374	(60.96) 2.400	(63.47) 2.499

**NOTES:**

1. MATERIAL: G.F. POLYESTER, 94V-0, COLOR: BLACK
2. HOUSING TO BE USED WITH TERMINAL NO. 71271.
3. SEE CHART FOR AVAILABLE CIRCUIT SIZES.
4. TO BE USED WITH MOLEX HEADER ASSEMBLY NUMBERS 71273, 71274, 71275, AND 71276.
5. DIMENSIONS ARE SHOWN FOR REFERENCE ONLY.
6. REFER TO MOLEX PRODUCT SPECIFICATION PSX-71271.
7. PACKAGE PER PK-70066-100.

B ADD PKG NOTE  
ECN2000-0468  
SCHAFER 99/12/1  
RELEASED  
PER ECR \* U31451  
A 03/31/94 REED

0 0  
HOUSING - CONNECTOR  
W/POLARIZATION SLOTS & RIBS  
(2.54)/.100 GRID STACKABLE  
1 OF 1 10 12 93