

78 Series Regulators

500mA Output 78 series Regulators

1A Output 78 series Regulators

BA78□□,BA78M□□Series



UNIVERSAL STANDARD SPECIFICATION

●Description

BA78□□, BA78M□□ series are three-terminal regulators available with several fixed output voltages. It supplies the stable fixed voltage from unstable direct input voltage. The useful output voltage lineup is 5V, 6V, 7V, 8V, 9V, 10V, 12V, 15V, 18V, 20V, 24V with 0.5A / 1A current ability. They have nearly same electric characteristics as competitor products and cover a wide range of application.

●Features

- 1) Built-in over-current protection circuit and thermal shutdown circuit
- 2) High ripple rejection
- 3) Available TO220CP-3, TO252-3 package to a wide range application
- 4) Compatible replacement to competitor products
- 5) Various voltage lineup (5V, 6V, 7V, 8V, 9V, 10V, 12V, 15V, 18V, 20V, 24V)

●Applications

Fixed voltage power supply for TV, Audio components, etc

●Line up

■1A BA78□□Series

| Part Number | 5V | 6V | 7V | 8V | 9V | 10V | 12V | 15V | 18V | 20V | 24V | Package |
|-------------|----|----|----|----|----|-----|-----|-----|-----|-----|-----|-----------|
| BA78□□CP | ○ | ○ | ○ | ○ | ○ | ○ | ○ | ○ | ○ | ○ | ○ | TO220CP-3 |
| BA78□□FP | ○ | ○ | ○ | ○ | ○ | ○ | ○ | ○ | ○ | ○ | ○ | TO252-3 |

■0.5A BA78M□□Series

| Part Number | 5V | 6V | 7V | 8V | 9V | 10V | 12V | 15V | 18V | 20V | 24V | Package |
|-------------|----|----|----|----|----|-----|-----|-----|-----|-----|-----|-----------|
| BA78M□□CP | ○ | ○ | ○ | ○ | ○ | ○ | ○ | ○ | ○ | ○ | ○ | TO220CP-3 |
| BA78M□□FP | ○ | ○ | ○ | ○ | ○ | ○ | ○ | ○ | ○ | ○ | ○ | TO252-3 |

●Output Voltage and Marking

Part Number : BA78□□□□ (1A)
 $\frac{\quad}{a} \frac{\quad}{b}$

Part Number : BA78M□□□□ (0.5A)
 $\frac{\quad}{a} \frac{\quad}{b}$

| Symbol | assignment of output voltage | | | |
|--------|---|--------------------|----|--------------------|
| a | □□ | Output voltage (V) | □□ | Output voltage (V) |
| | 05 | 5.0V typ. | 12 | 12V typ. |
| | 06 | 6.0V typ. | 15 | 15V typ. |
| | 07 | 7.0V typ. | 18 | 18V typ. |
| | 08 | 8.0V typ. | 20 | 20V typ. |
| | 09 | 9.0V typ. | 24 | 24V typ. |
| | 10 | 10.0V typ. | | |
| b | Package CP : TO220CP-3 FP : TO252-3 | | | |

| Symbol | assignment of output voltage | | | |
|--------|---|--------------------|----|--------------------|
| a | □□ | Output voltage (V) | □□ | Output voltage (V) |
| | 05 | 5.0V typ. | 12 | 12V typ. |
| | 06 | 6.0V typ. | 15 | 15V typ. |
| | 07 | 7.0V typ. | 18 | 18V typ. |
| | 08 | 8.0V typ. | 20 | 20V typ. |
| | 09 | 9.0V typ. | 24 | 24V typ. |
| | 10 | 10.0V typ. | | |
| b | Package CP : TO220CP-3 FP : TO252-3 | | | |

●Absolute Maximum Rating (Ta=25°C)

BA78□□CP/FP, BA78M□□CP/FP

| Parameter | Symbol | Limits | Unit |
|--------------------------------------|-----------|----------|------|
| Power supply voltage | Vin | 35 | V |
| Power Dissipation 1 | TO220CP-3 | 2 *1 | W |
| | TO252-3 | 1 *1 | |
| Power Dissipation 2 | TO220CP-3 | 22 *2 | W |
| | TO252-3 | 10 *2 | |
| Output Current | BA78□□ | 1 *3 | A |
| | BA78□□M | 0.5 *3 | |
| Operating Temperature Range | Topr | -40~+85 | °C |
| Storage Temperature Range | Tstg | -55~+150 | °C |
| Operating Junction Temperature Range | Tj | -40~+150 | °C |

* 1 Derating in done 16mW/°C(TO220CP-3), 8mW/°C(TO252-3) for temperatures above Ta=25°C

* 2 Derating in done 176mW/°C(TO220CP-3), 80mW/°C(TO252-3) for temperatures above Ta=25°C, Mounted on infinity Aluminium heat sink.

* 3 Pd,ASO and Tjmax(150°C) should not be exceeded.

●Operating Conditions(Ta=25°C, Pd should not be exceeded)

BA78□□CP/FP

| Parameter | Symbol | Min. | Max. | Unit. | |
|----------------|--------|--------|------|-------|---|
| Input Voltage | Vin | BA7805 | 7.5 | 25 | V |
| | | BA7806 | 8.5 | 21 | |
| | | BA7807 | 9.5 | 22 | |
| | | BA7808 | 10.5 | 23 | |
| | | BA7809 | 11.5 | 26 | |
| | | BA7810 | 12.5 | 25 | |
| | | BA7812 | 14.5 | 27 | |
| | | BA7815 | 17.5 | 30 | |
| | | BA7818 | 21 | 33 | |
| | | BA7820 | 23 | 33 | |
| BA7824 | 27 | 33 | | | |
| Output Current | Io | - | 1 | A | |

BA78M□□CP/FP

| Parameter | Symbol | Min. | Max. | Unit. | |
|----------------|--------|---------|------|-------|---|
| Input Voltage | Vin | BA78M05 | 7.5 | 25 | V |
| | | BA78M06 | 8.5 | 21 | |
| | | BA78M07 | 9.5 | 22 | |
| | | BA78M08 | 10.5 | 23 | |
| | | BA78M09 | 11.5 | 26 | |
| | | BA78M10 | 12.5 | 25 | |
| | | BA78M12 | 14.5 | 27 | |
| | | BA78M15 | 17.5 | 30 | |
| | | BA78M18 | 21 | 33 | |
| | | BA78M20 | 23 | 33 | |
| BA78M24 | 27 | 33 | | | |
| Output Current | Io | - | 0.5 | A | |

●BA78M□□CP/FP

ELECTRICAL CHARACTERISTICS

(Ta=25°C, Vin=10V(05), 11V(06), 13V(07), 14V(08), 15V(09), 16V(10), 19V(12), 23V(15), 27V(18), 29V(20), 33V(24),
Io=350mA unless otherwise specified)

| Parameter | Symbol | Type | Limit | | | Unit | Condition |
|---|--------|-------------------|-------|------|-------|--------------------------|---------------------------------|
| | | | Min | Typ | Max | | |
| Output Voltage 1 | Vo1 | 05 | 4.8 | 5.0 | 5.2 | V | Io=350mA |
| | | 06 | 5.75 | 6.0 | 6.25 | | |
| | | 07 | 6.7 | 7.0 | 7.3 | | |
| | | 08 | 7.7 | 8.0 | 8.3 | | |
| | | 09 | 8.6 | 9.0 | 9.4 | | |
| | | 10 | 9.6 | 10.0 | 10.4 | | |
| | | 12 | 11.5 | 12.0 | 12.5 | | |
| | | 15 | 14.4 | 15.0 | 15.6 | | |
| | | 18 | 17.3 | 18.0 | 18.7 | | |
| | | 20 | 19.2 | 20.0 | 20.8 | | |
| | | 24 | 23.0 | 24.0 | 25.0 | | |
| Output Voltage 2 | Vo2 | 05 | 4.75 | — | 5.25 | V | Vin=7.5~20V, Io=5mA~350mA |
| | | 06 | 5.7 | — | 6.3 | | Vin=8.5~21V, Io=5mA~350mA |
| | | 07 | 6.65 | — | 7.35 | | Vin=9.5~22V, Io=5mA~350mA |
| | | 08 | 7.6 | — | 8.4 | | Vin=10.5~23V, Io=5mA~350mA |
| | | 09 | 8.55 | — | 9.45 | | Vin=11.5~24V, Io=5mA~350mA |
| | | 10 | 9.5 | — | 10.5 | | Vin=12.5~25V, Io=5mA~350mA |
| | | 12 | 11.4 | — | 12.6 | | Vin=15~27V, Io=5mA~350mA |
| | | 15 | 14.25 | — | 15.75 | | Vin=17.5~30V, Io=5mA~350mA |
| | | 18 | 17.1 | — | 18.9 | | Vin=21~33V, Io=5mA~350mA |
| | | 20 | 19.0 | — | 21.0 | | Vin=23~33V, Io=5mA~350mA |
| | | 24 | 22.8 | — | 25.2 | Vin=27~33V, Io=5mA~350mA | |
| Line Regulation 1 | Reg.I1 | 05 | — | 3 | 100 | mV | Vin=7~25V, Io=200mA |
| | | 06 | — | 3 | 100 | | Vin=8~25V, Io=200mA |
| | | 07 | — | 4 | 100 | | Vin=9~25V, Io=200mA |
| | | 08 | — | 4 | 100 | | Vin=10.5~25V, Io=200mA |
| | | 09 | — | 4 | 100 | | Vin=11.5~26V, Io=200mA |
| | | 10 | — | 5 | 100 | | Vin=12.5~28V, Io=200mA |
| | | 12 | — | 5 | 100 | | Vin=14.5~30V, Io=200mA |
| | | 15 | — | 6 | 100 | | Vin=17.5~30V, Io=200mA |
| | | 18 | — | 7 | 100 | | Vin=21~33V, Io=200mA |
| | | 20 | — | 8 | 100 | | Vin=23~33V, Io=200mA |
| | | 24 | — | 10 | 100 | Vin=27~33V, Io=200mA | |
| Line Regulation 2 | Reg.I2 | 05 | — | 1 | 50 | mV | Vin=8~12V, Io=200mA |
| | | 06 | — | 1 | 50 | | Vin=9~25V, Io=200mA |
| | | 07 | — | 1 | 50 | | Vin=10~25V, Io=200mA |
| | | 08 | — | 1 | 50 | | Vin=11~25V, Io=200mA |
| | | 09 | — | 2 | 50 | | Vin=12~25V, Io=200mA |
| | | 10 | — | 2 | 50 | | Vin=14~26V, Io=200mA |
| | | 12 | — | 3 | 50 | | Vin=16~30V, Io=200mA |
| | | 15 | — | 3 | 50 | | Vin=20~30V, Io=200mA |
| | | 18 | — | 3 | 50 | | Vin=24~33V, Io=200mA |
| | | 20 | — | 4 | 50 | | Vin=24~33V, Io=200mA |
| | | 24 | — | 5 | 50 | Vin=28~33V, Io=200mA | |
| Ripple Rejection | R.R. | 05 | 62 | 78 | — | dB | ein=1Vrms, f=120Hz, Io=100mA |
| | | 06 | 60 | 74 | — | | |
| | | 07 | 57 | 71 | — | | |
| | | 08 | 56 | 69 | — | | |
| | | 09 | 56 | 67 | — | | |
| | | 10 | 56 | 66 | — | | |
| | | 12 | 55 | 63 | — | | |
| | | 15 | 54 | 60 | — | | |
| | | 18 | 53 | 58 | — | | |
| | | 20 | 53 | 58 | — | | |
| | | 24 | 50 | 55 | — | | |
| Temperature Coefficient of Output Voltage | Tcvo | 05 | — | -1.0 | — | mV/°C | Io=5mA, Tj=0~125°C |
| | | 06/07/08/09/10/12 | — | -0.5 | — | | |
| | | 15/18 | — | -0.6 | — | | |
| | | 20/24 | — | -0.7 | — | | |
| Peak Output Current | Io-p | common | — | 875 | — | mA | Tj=25°C |
| Dropout Voltage | Vd | common | — | 2.0 | — | V | Io=500mA |

●BA78M□□CP/FP

ELECTRICAL CHARACTERISTICS

(Ta=25°C, Vin=10V(05), 11V(06), 13V(07), 14V(08), 15V(09), 16V(10), 19V(12), 23V(15), 27V(18), 29V(20), 33V(24),
Io=350mA unless otherwise specified)

| Parameter | Symbol | Type | Limit | | | Unit | Condition |
|------------------------------|--------|----------------------|-------|------|-----|------|------------------------|
| | | | Min | Typ | Max | | |
| Load Regulation 1 | Reg.L1 | 05 | — | 20 | 100 | mV | Io=5mA~500mA |
| | | 06 | — | 20 | 120 | | |
| | | 07 | — | 20 | 140 | | |
| | | 08 | — | 20 | 160 | | |
| | | 09 | — | 20 | 180 | | |
| | | 10 | — | 20 | 200 | | |
| | | 12 | — | 20 | 240 | | |
| | | 15 | — | 20 | 300 | | |
| | | 18 | — | 20 | 360 | | |
| | | 20 | — | 20 | 400 | | |
| Load Regulation 2 | Reg.L2 | 05 | — | 10 | 50 | mV | Io=5mA~200mA |
| | | 06 | — | 10 | 60 | | |
| | | 07 | — | 10 | 70 | | |
| | | 08 | — | 10 | 80 | | |
| | | 09 | — | 10 | 90 | | |
| | | 10 | — | 10 | 100 | | |
| | | 12 | — | 10 | 120 | | |
| | | 15 | — | 10 | 150 | | |
| | | 18 | — | 10 | 180 | | |
| | | 20 | — | 10 | 200 | | |
| Output Noise Voltage | Vn | 05 | — | 40 | — | μV | f=10Hz~100kHz |
| | | 06 | — | 60 | — | | |
| | | 07 | — | 70 | — | | |
| | | 08 | — | 80 | — | | |
| | | 09 | — | 90 | — | | |
| | | 10 | — | 100 | — | | |
| | | 12 | — | 110 | — | | |
| | | 15 | — | 130 | — | | |
| | | 18 | — | 140 | — | | |
| | | 20 | — | 150 | — | | |
| Bias Current | Ib | common | — | 4.5 | 6.0 | mA | Io=0mA |
| Bias Current Change1 | Ib1 | common | — | — | 0.5 | mA | Io=5mA~350mA |
| Bias Current Change 2 | Ib2 | 05 | — | — | 0.8 | mA | Vin:8~25V, Io=200mA |
| | | 06 | — | — | 0.8 | | Vin:9~25V, Io=200mA |
| | | 07 | — | — | 0.8 | | Vin:10~25V, Io=200mA |
| | | 08 | — | — | 0.8 | | Vin:10.5~25V, Io=200mA |
| | | 09 | — | — | 0.8 | | Vin:12~25V, Io=200mA |
| | | 10 | — | — | 0.8 | | Vin:13~25V, Io=200mA |
| | | 12 | — | — | 0.8 | | Vin:14.5~30V, Io=200mA |
| | | 15 | — | — | 0.8 | | Vin:17.5~30V, Io=200mA |
| | | 18 | — | — | 0.8 | | Vin:21~33V, Io=200mA |
| | | 20 | — | — | 0.8 | | Vin:23~33V, Io=200mA |
| Short-Circuit Output Current | Ios | 05/06/07/08 | — | 0.4 | — | A | Vin=25V |
| | | 09/10/12/15/18/20/24 | — | 0.17 | — | | Vin=30V |
| Output Resistance | Ro | 05 | — | 9 | — | mΩ | f=1kHz |
| | | 06 | — | 10 | — | | |
| | | 07 | — | 11 | — | | |
| | | 08 | — | 12 | — | | |
| | | 09 | — | 13 | — | | |
| | | 10 | — | 14 | — | | |
| | | 12 | — | 16 | — | | |
| | | 15 | — | 19 | — | | |
| | | 18 | — | 22 | — | | |
| 20 | — | 25 | — | | | | |
| 24 | — | 37 | — | | | | |

●BA78□□CP/FP

ELECTRICAL CHARACTERISTICS

(Ta=25°C, Vin=10V(05), 11V(06), 13V(07), 14V(08), 15V(09), 16V(10), 19V(12), 23V(15), 27V(18), 29V(20), 33V(24),
Io=500mA unless otherwise specified)

| Parameter | Symbol | Type | Limit | | | Unit | Condition | | |
|---|--------|--------|-------|-------------------------|------|-------|---------------------------------|---|-------------------------|
| | | | Min | Typ | Max | | | | |
| Output Voltage 1 | Vo1 | 05 | 4.8 | 5.0 | 5.2 | V | Io=500mA | | |
| | | 06 | 5.75 | 6.0 | 6.25 | | | | |
| | | 07 | 6.7 | 7.0 | 7.3 | | | | |
| | | 08 | 7.7 | 8.0 | 8.3 | | | | |
| | | 09 | 8.6 | 9.0 | 9.4 | | | | |
| | | 10 | 9.6 | 10.0 | 10.4 | | | | |
| | | 12 | 11.5 | 12.0 | 12.5 | | | | |
| | | 15 | 14.4 | 15.0 | 15.6 | | | | |
| | | 18 | 17.3 | 18.0 | 18.7 | | | | |
| Output Voltage 2 | Vo2 | 20 | 19.2 | 20.0 | 20.8 | V | Io=500mA | | |
| | | 24 | 23.0 | 24.0 | 25.0 | | | | |
| | | 05 | 4.75 | — | 5.25 | | | V | Vin=7.5~20V, Io=5mA~1A |
| | | 06 | 5.7 | — | 6.3 | | | | Vin=8.5~21V, Io=5mA~1A |
| | | 07 | 6.65 | — | 7.35 | | | | Vin=9.5~22V, Io=5mA~1A |
| | | 08 | 7.6 | — | 8.4 | | | | Vin=10.5~23V, Io=5mA~1A |
| | | 09 | 8.55 | — | 9.45 | | | | Vin=11.5~26V, Io=5mA~1A |
| | | 10 | 9.5 | — | 10.5 | | | | Vin=12.5~25V, Io=5mA~1A |
| | | 12 | 11.4 | — | 12.6 | | | | Vin=15~27V, Io=5mA~1A |
| 15 | 14.25 | — | 15.75 | Vin=17.5~30V, Io=5mA~1A | | | | | |
| 18 | 17.1 | — | 18.9 | Vin=21~33V, Io=5mA~1A | | | | | |
| 20 | 19.0 | — | 21.0 | Vin=23~33V, Io=5mA~1A | | | | | |
| 24 | 22.8 | — | 25.2 | Vin=27~33V, Io=5mA~1A | | | | | |
| Line Regulation 1 | Reg.I1 | 05 | — | 3 | 100 | mV | Vin=7~25V, Io=500mA | | |
| | | 06 | — | 4 | 120 | | Vin=8~25V, Io=500mA | | |
| | | 07 | — | 5 | 140 | | Vin=9~25V, Io=500mA | | |
| | | 08 | — | 5 | 160 | | Vin=10.5~25V, Io=500mA | | |
| | | 09 | — | 6 | 180 | | Vin=11.5~26V, Io=500mA | | |
| | | 10 | — | 7 | 200 | | Vin=12.5~27V, Io=500mA | | |
| | | 12 | — | 8 | 240 | | Vin=14.5~30V, Io=500mA | | |
| | | 15 | — | 9 | 300 | | Vin=17.5~30V, Io=500mA | | |
| | | 18 | — | 10 | 360 | | Vin=21~33V, Io=500mA | | |
| Line Regulation 2 | Reg.I2 | 20 | — | 12 | 400 | mV | Vin=23~33V, Io=500mA | | |
| | | 24 | — | 15 | 480 | | Vin=27~33V, Io=500mA | | |
| | | 05 | — | 1 | 50 | | Vin=8~12V, Io=500mA | | |
| | | 06 | — | 2 | 60 | | Vin=9~13V, Io=500mA | | |
| | | 07 | — | 2 | 70 | | Vin=10~15V, Io=500mA | | |
| | | 08 | — | 3 | 80 | | Vin=11~17V, Io=500mA | | |
| | | 09 | — | 4 | 90 | | Vin=13~19V, Io=500mA | | |
| | | 10 | — | 4 | 100 | | Vin=14~20V, Io=500mA | | |
| | | 12 | — | 5 | 120 | | Vin=16~22V, Io=500mA | | |
| Ripple Rejection | R.R. | 15 | — | 5 | 150 | dB | ein=1Vrms, f=120Hz, Io=100mA | | |
| | | 18 | — | 5 | 180 | | | | |
| | | 20 | — | 7 | 200 | | | | |
| | | 24 | — | 10 | 240 | | | | |
| | | 05 | 62 | 78 | — | | | | |
| | | 06 | 59 | 73 | — | | | | |
| | | 07 | 57 | 69 | — | | | | |
| | | 08 | 56 | 65 | — | | | | |
| | | 09 | 56 | 64 | — | | | | |
| Temperature Coefficient of Output Voltage | Tcvo | 10 | 55 | 64 | — | mV/°C | Io=5mA, Tj=0~125°C | | |
| | | 12 | 55 | 63 | — | | | | |
| | | 15/18 | — | -0.6 | — | | | | |
| | | 20/24 | — | -0.7 | — | | | | |
| Peak Output Current | Io-p | common | — | 1.7 | — | A | Tj=25°C | | |
| Dropout Voltage | Vd | common | — | 2.0 | — | V | Io=1A | | |

●BA78□□CP/FP

ELECTRICAL CHARACTERISTICS

(Ta=25°C, Vin=10V(05), 11V(06), 13V(07), 14V(08), 15V(09), 16V(10), 19V(12), 23V(15), 27V(18), 29V(20), 33V(24),
Io=500mA unless otherwise specified)

| Parameter | Symbol | Type | Limit | | | Unit | Condition |
|------------------------------|--------|----------------------|-------|-----|-----|----------------------|------------------------|
| | | | Min | Typ | Max | | |
| Load Regulation 1 | Reg.L1 | 05 | — | 15 | 100 | mV | Io=5mA~1A |
| | | 06 | — | 16 | 120 | | |
| | | 07 | — | 17 | 140 | | |
| | | 08 | — | 19 | 160 | | |
| | | 09 | — | 20 | 180 | | |
| | | 10 | — | 21 | 200 | | |
| | | 12 | — | 23 | 200 | | |
| | | 15 | — | 27 | 300 | | |
| | | 18 | — | 30 | 360 | | |
| | | 20 | — | 32 | 400 | | |
| | | 24 | — | 37 | 480 | | |
| Load Regulation 2 | Reg.L2 | 05 | — | 5 | 50 | mV | Io=250mA~750mA |
| | | 06 | — | 6 | 60 | | |
| | | 07 | — | 6 | 70 | | |
| | | 08 | — | 7 | 80 | | |
| | | 09 | — | 8 | 90 | | |
| | | 10 | — | 8 | 90 | | |
| | | 12 | — | 10 | 100 | | |
| | | 15 | — | 10 | 150 | | |
| | | 18 | — | 12 | 180 | | |
| | | 20 | — | 14 | 200 | | |
| | | 24 | — | 15 | 240 | | |
| Output Noise Voltage | Vn | 05 | — | 40 | — | μV | f=10Hz~100kHz |
| | | 06 | — | 60 | — | | |
| | | 07 | — | 70 | — | | |
| | | 08 | — | 80 | — | | |
| | | 09 | — | 90 | — | | |
| | | 10 | — | 100 | — | | |
| | | 12 | — | 110 | — | | |
| | | 15 | — | 125 | — | | |
| | | 18 | — | 140 | — | | |
| | | 20 | — | 150 | — | | |
| | | 24 | — | 180 | — | | |
| Bias Current | Ib | common | — | 4.5 | 8.0 | mA | Io=0mA |
| Bias Current Change 1 | Ib1 | common | — | — | 0.5 | mA | Io=5mA~1A |
| Bias Current Change 2 | Ib2 | 05 | — | — | 0.8 | mA | Vin:8~25V, Io=500mA |
| | | 06 | — | — | 0.8 | | Vin:8.5~25V, Io=500mA |
| | | 07 | — | — | 0.8 | | Vin:9.5~25V, Io=500mA |
| | | 08 | — | — | 0.8 | | Vin:10.5~25V, Io=500mA |
| | | 09 | — | — | 0.8 | | Vin:11.5~26V, Io=500mA |
| | | 10 | — | — | 0.8 | | Vin:12.5~27V, Io=500mA |
| | | 12 | — | — | 0.8 | | Vin:14.5~30V, Io=500mA |
| | | 15 | — | — | 0.8 | | Vin:17.5~30V, Io=500mA |
| | | 18 | — | — | 0.8 | | Vin:21~33V, Io=500mA |
| | | 20 | — | — | 0.8 | | Vin:23~33V, Io=500mA |
| | | 24 | — | — | 0.8 | Vin:27~33V, Io=500mA | |
| Short-Circuit Output Current | Ios | 05/06/07/08 | — | 0.6 | — | A | Vin=25V |
| | | 09/10/12/15/18/20/24 | — | 0.3 | — | | Vin=30V |
| Output Resistance | Ro | 05 | — | 9 | — | mΩ | f=1kHz |
| | | 06 | — | 10 | — | | |
| | | 07 | — | 10 | — | | |
| | | 08 | — | 10 | — | | |
| | | 09 | — | 10 | — | | |
| | | 10 | — | 11 | — | | |
| | | 12 | — | 12 | — | | |
| | | 15 | — | 14 | — | | |
| | | 18 | — | 17 | — | | |
| | | 20 | — | 19 | — | | |
| | | 24 | — | 27 | — | | |

●BA78M□□ Characteristics data(Ta=25°C, Vin=10V(05), 14V(08), 23V(15) unless otherwise specified)

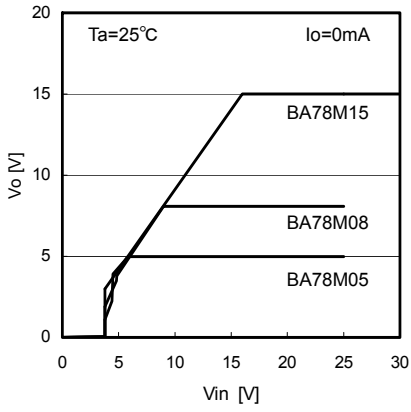

Fig.1 Line Regulation (Io=0mA)

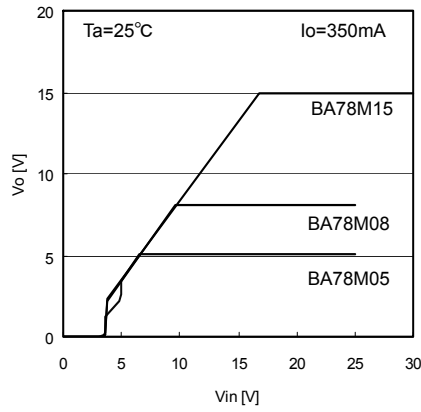

Fig.2 Line Regulation (Io=350mA)

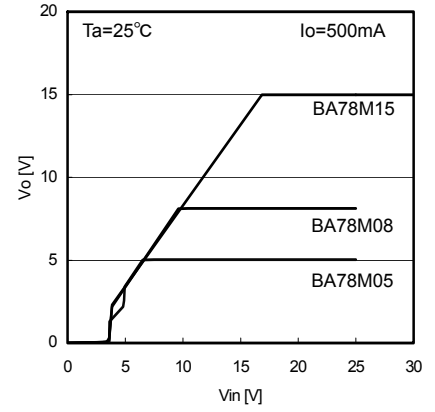

Fig.3 Line Regulation (Io=500mA)

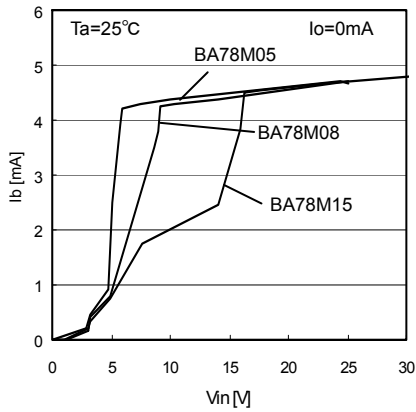

Fig.4 Vin - Ib

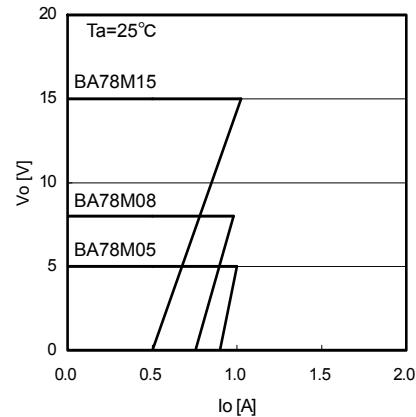

Fig.5 Load Regulation

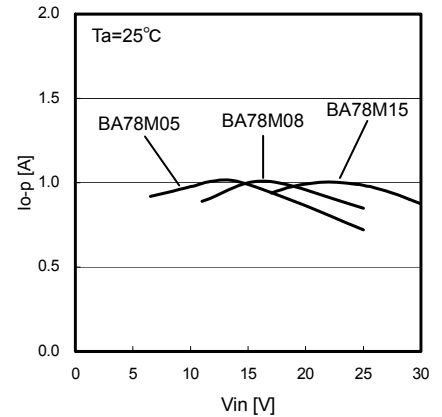

Fig.6 Peak Output Current

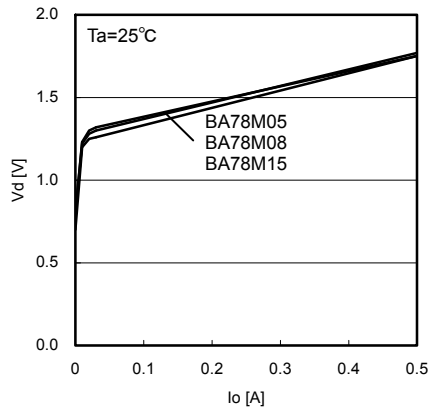

Fig.7 Dropout Voltage

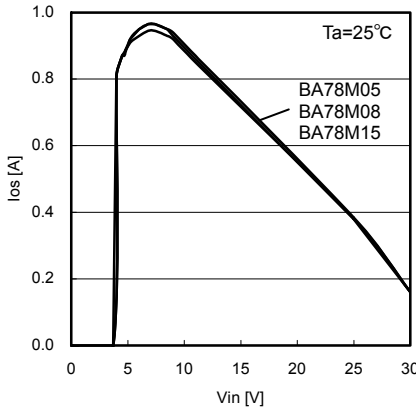

Fig.8 Short - Circuit Output Current

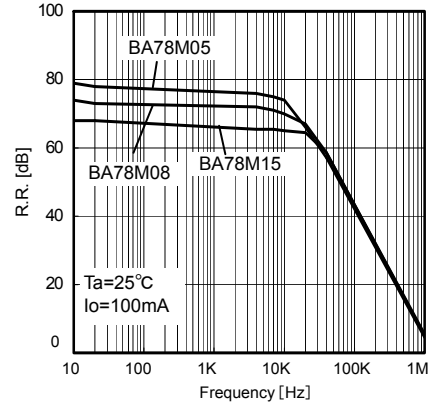

Fig.9 Ripple Rejection Ratio

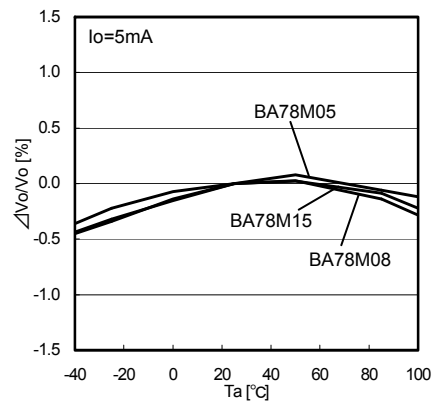

Fig.10 Ta - Vo

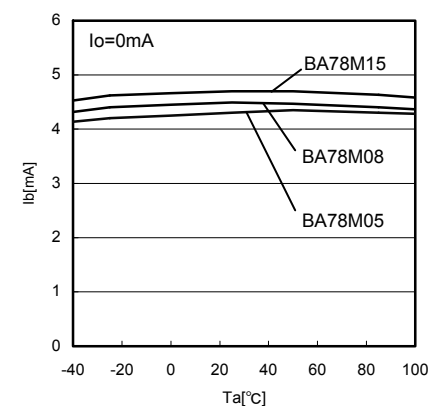

Fig.11 Ta - Ib

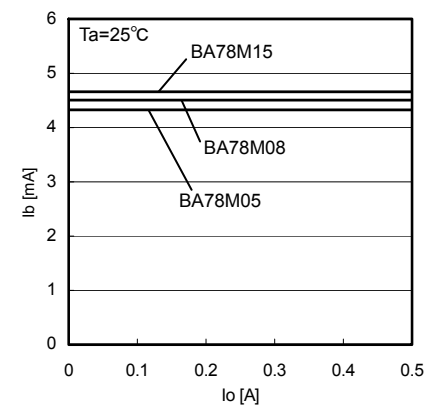

Fig.12 Io - Ib

●BA78□□ Characteristics data (Ta=25°C, Vin=10V(05), 14V(08), 23V(15) unless otherwise specified)

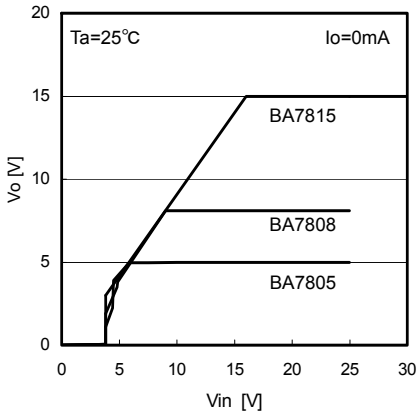

Fig.13 Line Regulation ($I_o=0\text{mA}$)

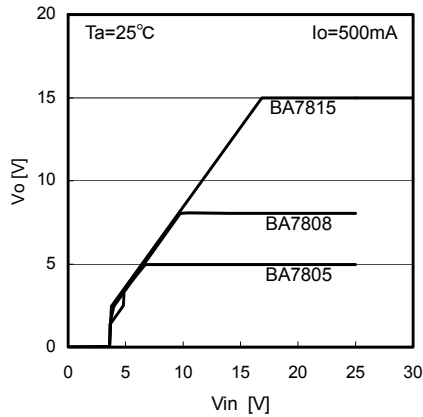

Fig.14 Line Regulation ($I_o=500\text{mA}$)

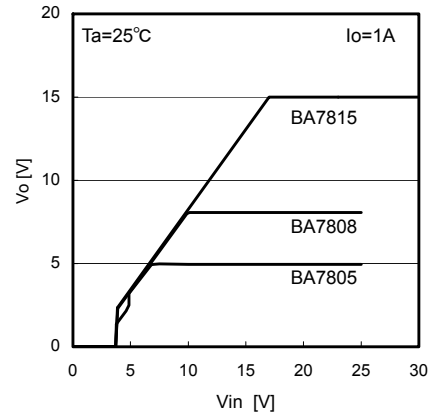

Fig.15. Line Regulation ($I_o=1\text{A}$)

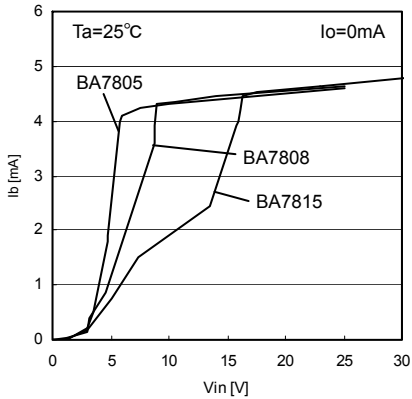

Fig.16 $V_{in} - I_b$

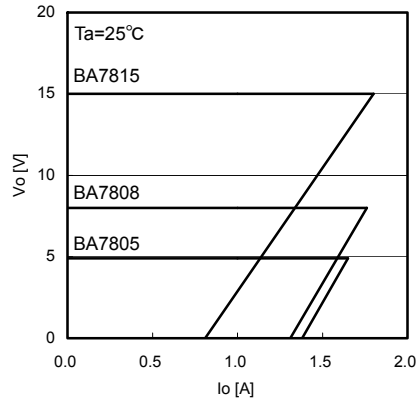

Fig.17 Load Regulation

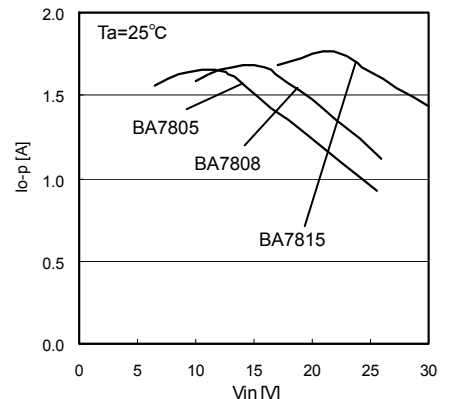

Fig.18 Peak Output Current

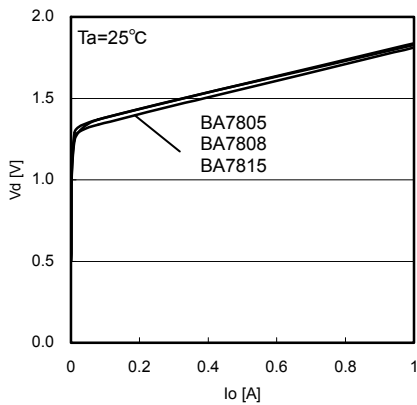

Fig.19 Dropout Voltage

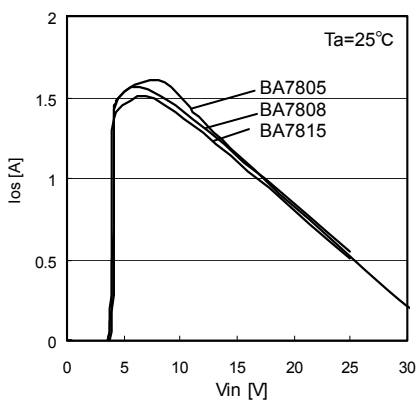

Fig.20 Short - Circuit Output Current

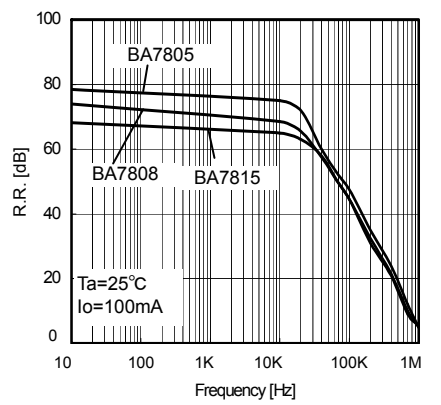

Fig.21 Ripple Rejection Ratio

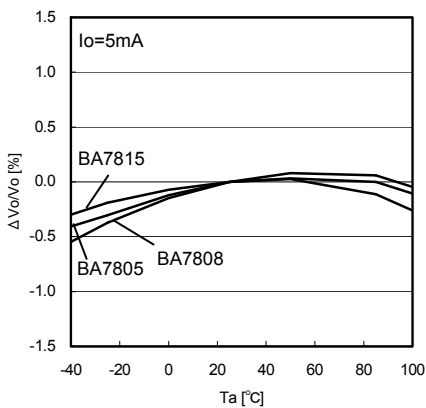

Fig.22 $T_a - V_o$

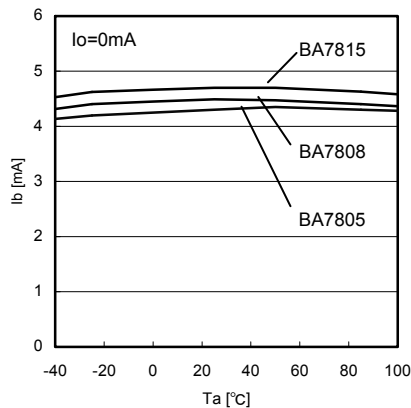

Fig.23 $T_a - I_b$

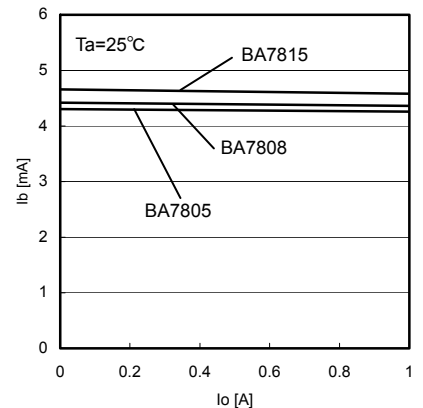
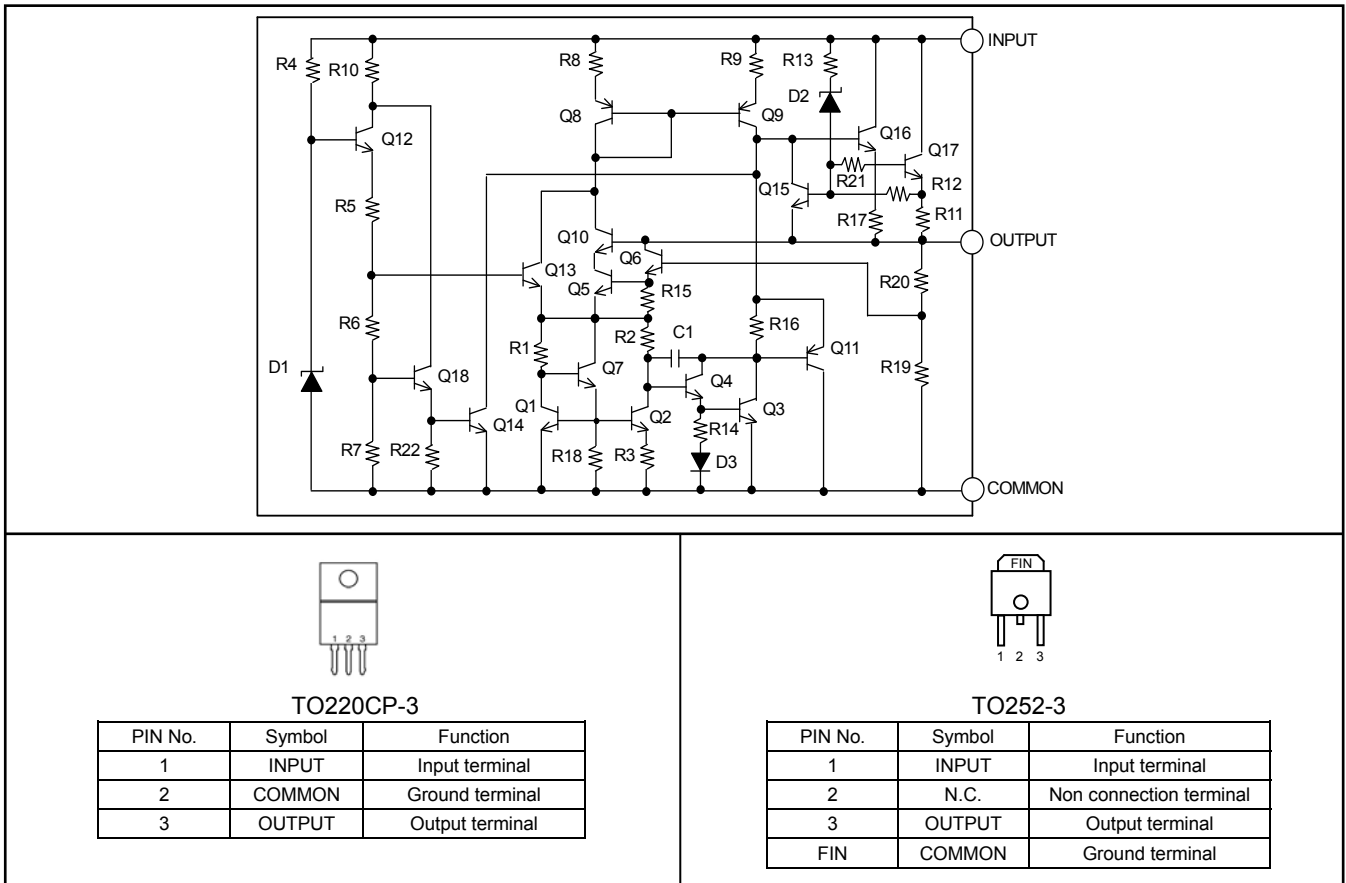

Fig.24 $I_o - I_b$

● Internal Circuit Structural Diagram



● Protection Circuit

(1) Over-current protection circuit

When the maximum rating current or more is rushed, it controls the current ability and protects the IC from destruction.

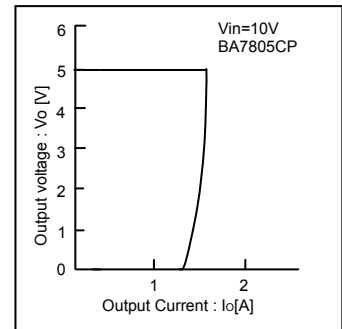

(2) Thermal shutdown circuit

When the chip temperature of IC exceeds the setting temperature, the IC goes OFF, and it controls the IC not to be destroyed by the heat generation. It can be restored by being lowered the chip temperature of IC below the setting temperature.

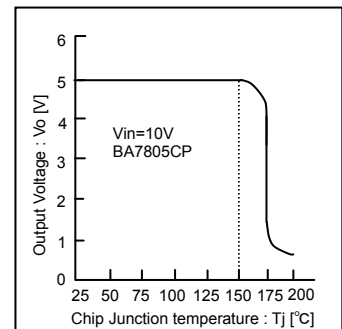

(3) Safety operation area control circuit

It controls the output current in inverse proportion ratio to voltage difference (input-output). When voltage difference becomes bigger, the IC will be destroyed in rush current. It protects the IC by controlling the current ability according to the voltage level.

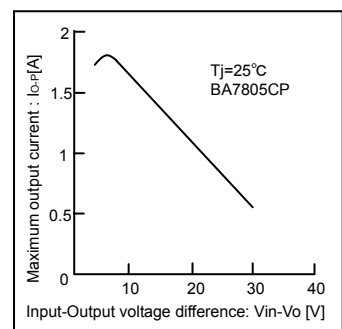

● Thermal design

Refer to the following thermal derating curves (Fig. 25, 26), when using in the status of Ta=25°C or more.

The characteristic of IC is greatly related to the operating temperature.

When it is used in over maximum junction temperature, the elements inside IC might become weaker and be destroyed. It is recommended to take into consideration thermal of IC.

Note that the temperatures are in the allowed temperature limits and operated within Pd.

It is necessary to operate it at junction temperature Tjmax or less to prevent IC from the thermal destruction.

Please operate IC within permissible loss Pd because the junction temperature Tj might become considerably a high temperature even if ambient temperature Ta is normal temperature (25°C).

Power consumption Pc(W) may be expressed by the equation shown below:

$$Pc = (V_{in} - V_o) \times I_o + V_{in} \times I_b$$

$$\text{permissible loss } Pd \geq Pc$$

$$I_o \leq \frac{Pd - V_{in} \times I_b}{V_{in} - V_o}$$

Vin : Input Voltage

Vo : Output Voltage

Io : Output Current

Ib : Bias current

Maximum Output current IoMAX can be calculated in thermal design.

• Calculation example

Ex.1) Ta=85°C, Vin =7.5V, Vo=5.0V

$$I_o \leq \frac{1.04 - 7.5 \times 4.5m}{7.5 - 5.0}$$

$$I_o \leq 400mA$$

Using TO220CP-3 alone
 $\theta_{ja} = 62.5^\circ\text{C/W} \rightarrow 16\text{mW}/^\circ\text{C}$
 Pd=1.04W at 85°C

Be sure to use this IC within a power dissipation at the range of operating temperature.

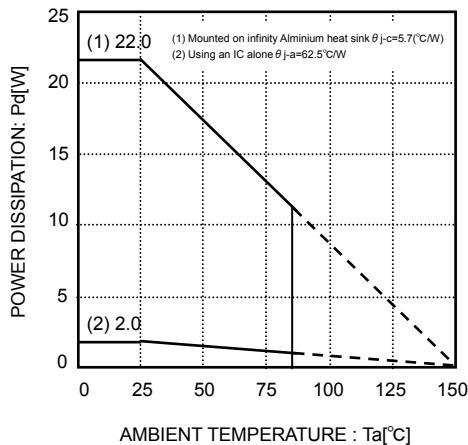

Fig.25 Thermal derating curve (TO220CP-3)

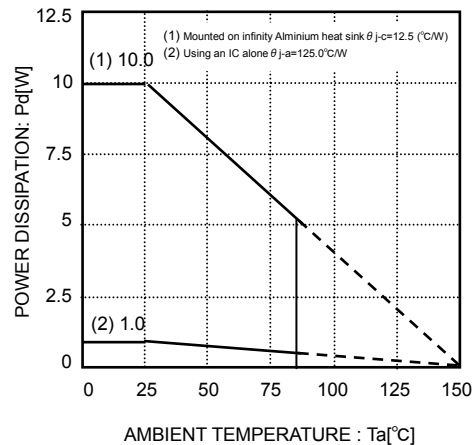

Fig.26 Thermal derating curve (TO252-3)

● Terminal Setting and Cautions

• INPUT

It is recommended that a capacitor (about 0.33uF) be inserted between INPUT and COMMON.

The value of capacitor is designed suitable for the actual application.

• OUTPUT

It is recommended that a capacitor (about 0.1uF) be inserted between OUTPUT and COMMON.

A tantalum capacitor can also be used for this pin because insufficient capacitors may cause oscillation by a temperature change.

• COMMON

Keep the no voltage drop between Ground level of set board and IC.

When there is the voltage difference, setting voltage becomes inaccuracy and unstable.

It is recommended to connect by wide, short pattern, and lower the impedance.

● Note For Use

(1) Absolute Maximum Ratings

While utmost care is taken to quality control of this product, any application that may exceed some of the absolute maximum ratings including the voltage applied and the operating temperature range may result in breakage. If broken, short-mode or open-mode may not be identified. So if it is expected to encounter with special mode that may exceed the absolute maximum ratings, it is requested to take necessary safety measures physically including insertion of fuses.

(2) Ground voltage

Make setting of the potential of the GND terminal so that it will be maintained at the minimum in any operating state. Furthermore, check to be sure no terminals are at a potential lower than the GND voltage including an actual electric transient.

(3) Thermal design

When you do the kind of use which exceeds Pd, It may be happened to deteriorating IC original quality such as decrease of electric current ability with chip temperature rise. Do not exceed the power dissipation (Pd) of the package specification rating under actual operation, and please design enough temperature margins.

(4) Short-circuiting between terminals, and mismounting

When mounting to pc board, care must be taken to avoid mistake in its orientation and alignment. Failure to do so may result in IC breakdown. Short-circuiting due to foreign matters entered between output terminals, or between output and power supply or GND may also cause breakdown.

(5) Operation in Strong electromagnetic field

Be noted that using the IC in the strong electromagnetic radiation can cause operation failures.

(6) Inspection with the IC set to a pc board

If a capacitor must be connected to the pin of lower impedance during inspection with the IC set to a pc board, the capacitor must be discharged after each process to avoid stress to the IC. For electrostatic protection, provide proper grounding to assembling processes with special care taken in handling and storage. When connecting to jigs in the inspection process, be sure to turn OFF the power supply before it is connected and removed.

(7) Input to IC terminals

This is a monolithic IC with P⁺ isolation between P-substrate and each element as illustrated below. This P-layer and the N-layer of each element form a P-N junction, and various parasitic element are formed.

If a resistor is joined to a transistor terminal as shown in Fig 28.

- P-N junction works as a parasitic diode if the following relationship is satisfied; GND > Terminal A (at resistor side), or GND > Terminal B (at transistor side); and
- If GND > Terminal B (at NPN transistor side),

a parasitic NPN transistor is activated by N-layer of other element adjacent to the above-mentioned parasitic diode.

The structure of the IC inevitably forms parasitic elements, the activation of which may cause interference among circuits, and/or malfunctions contributing to breakdown. It is therefore requested to take care not to use the device in such manner that the voltage lower than GND (at P-substrate) may be applied to the input terminal, which may result in activation of parasitic elements.

(8) Ground wiring pattern

If small-signal GND and large-current GND are provided, It will be recommended to separate the large-current GND pattern from the small-signal GND pattern and establish a single ground at the reference point of the set PCB so that resistance to the wiring pattern and voltage fluctuations due to a large current will cause no fluctuations in voltages of the small-signal GND. Pay attention not to cause fluctuations in the GND wiring pattern of external parts as well.

(9) Thermal shutdown circuit

A temperature control circuit is built in the IC to prevent the damage due to overheat.

Therefore, the output is turned off when the thermal circuit works and is turned on when the temperature goes down to the specified level.

But, built-in the IC a temperature control circuit to protect itself, and avoid the design used the thermal protection.

(10) Over current protection circuit

The over-current protection circuits are built in at output, according to their respective current outputs and prevent the IC from being damaged when the load is short-circuited or over-current. But, these protection circuits are effective for preventing destruction by unexpected accident. When it's in continuous protection circuit moving period don't use please. And for ability, because this chip has minus characteristic, be careful for heat plan.

(11) There is a possibility to damage an internal circuit or the element when Vin and the voltage of each terminal reverse in the application.

For instance, Vin is short-circuited to GND etc. with the charge charged to an external capacitor. Please use the capacitor of the output terminal with 1000μF or less. Moreover, the Vin series is recommended to insert the diode of the by-pass the diode of the backflow prevention or between each terminal and Vin.

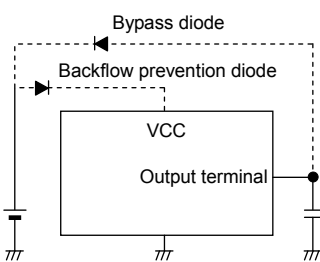

Fig.27 Bypass Diode

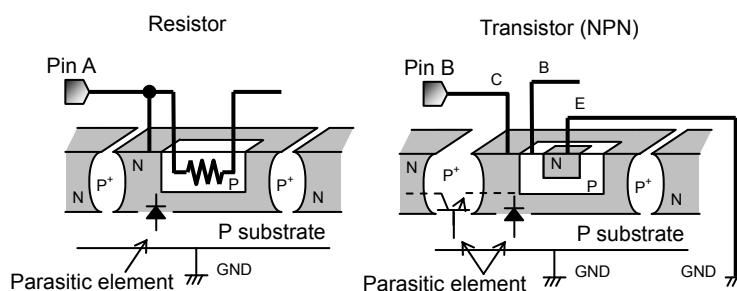
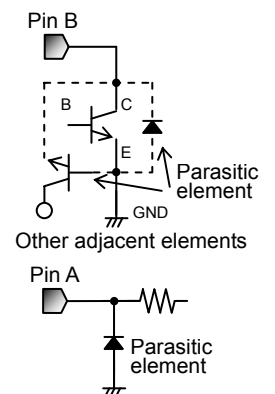
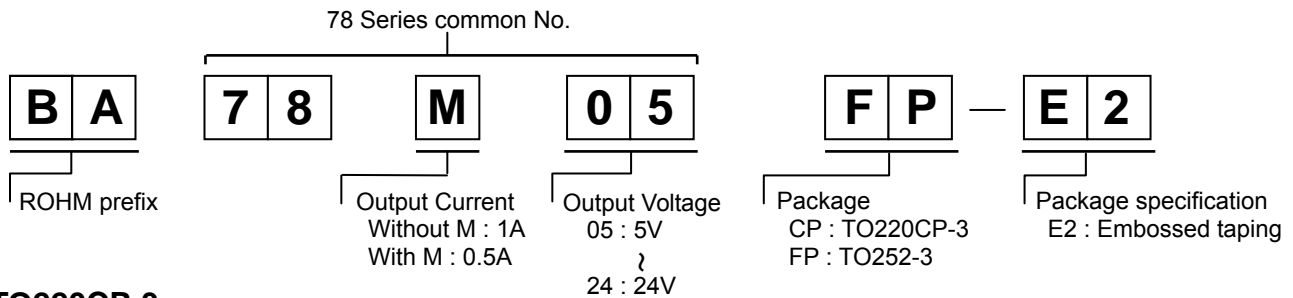

Fig.28 Simplified structure of monoristic IC



● Ordering part number



TO220CP-3

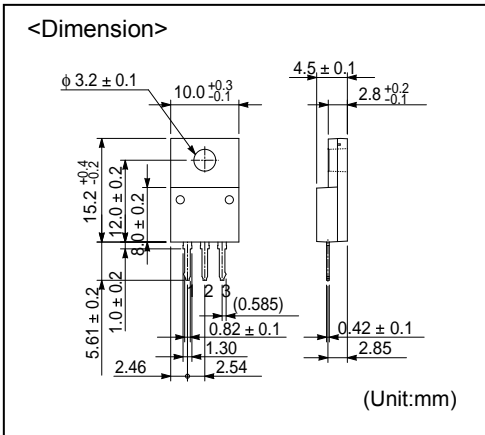

<Tape and Reel information >

| | |
|-------------------|---|
| Tape | Embossed carrier tape |
| Quantity | 500pcs |
| Direction Of feed | E2 (The direction is the 1pin of product is at the upper left when you hold reel on the left hand and you pull out the tape on the right hand) |

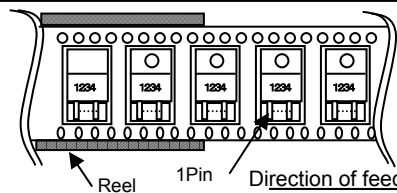

※When you order , please order in times the amount of package quantity.

TO252-3

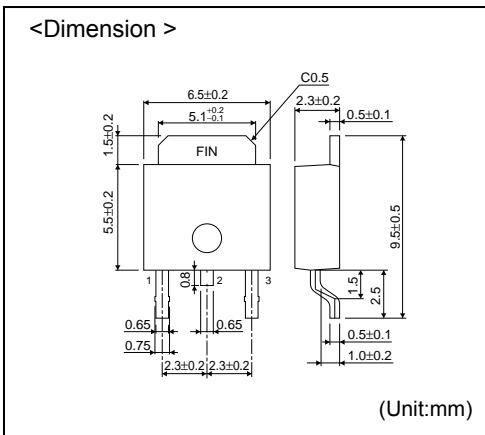

< Tape and Reel information >

| | |
|-------------------|---|
| Tape | Embossed carrier tape |
| Quantity | 2000pcs |
| Direction Of feed | E2 (The direction is the 1pin of product is at the upper left when you hold reel on the left hand and you pull out the tape on the right hand) |

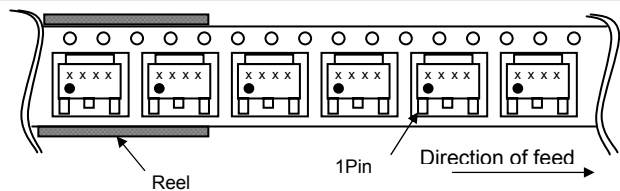

※When you order , please order in times the amount of package quantity.

- The contents described herein are correct as of September, 2008
- The contents described herein are subject to change without notice. For updates of the latest information, please contact and confirm with ROHM CO.,LTD.
- Any part of this application note must not be duplicated or copied without our permission.
- Application circuit diagrams and circuit constants contained herein are shown as examples of standard use and operation. Please pay careful attention to the peripheral conditions when designing circuits and deciding upon circuit constants in the set.
- Any data, including, but not limited to application circuit diagrams and information, described herein are intended only as illustrations of such devices and not as the specifications for such devices. ROHM CO.,LTD. disclaims any warranty that any use of such devices shall be free from infringement of any third party's intellectual property rights or other proprietary rights, and further, assumes no liability of whatsoever nature in the event of any such infringement, or arising from or connected with or related to the use of such devices.
- Upon the sale of any such devices, other than for buyer's right to use such devices itself, resale or otherwise dispose of the same, implied right or license to practice or commercially exploit any intellectual property rights or other proprietary rights owned or controlled by ROHM CO., LTD. is granted to any such buyer.
- The products described herein utilize silicon as the main material.
- The products described herein are not designed to be X ray proof.

The products listed in this catalog are designed to be used with ordinary electronic equipment or devices (such as audio visual equipment, office-automation equipment, communications devices, electrical appliances and electronic toys). Should you intend to use these products with equipment or devices which require an extremely high level of reliability and the malfunction of which would directly endanger human life (such as medical instruments, transportation equipment, aerospace machinery, nuclear-reactor controllers, fuel controllers and other safety devices), please be sure to consult with our sales representative in advance.

Contact us for further information about the products.

| | |
|---|--|
| <p>San Diego TEL: +1-858-625-3630 FAX: +1-858-625-3670</p> <p>Atlanta TEL: +1-770-754-5972 FAX: +1-770-754-0691</p> <p>Boston TEL: +1-978-371-0382 FAX: +1-928-438-7164</p> <p>Chicago TEL: +1-847-368-1006 FAX: +1-847-368-1008</p> <p>Dallas TEL: +1-469-287-5366 FAX: +1-469-362-7973</p> <p>Denver TEL: +1-303-708-0908 FAX: +1-303-708-0858</p> <p>Detroit TEL: +1-248-348-9920 FAX: +1-248-348-9942</p> <p>Nashville TEL: +1-615-620-6700 FAX: +1-615-620-6702</p> <p>Mexico TEL: +52-33-3123-2001 FAX: +52-33-3123-2002</p> <p>Düsseldorf TEL: +49-2154-9210 FAX: +49-2154-921400</p> <p>Munich TEL: +49-8999-216168 FAX: +49-8999-216176</p> <p>Stuttgart TEL: +49-711-7272-370 FAX: +49-711-7272-3720</p> <p>France TEL: +33-1-5697-3060 FAX: +33-1-5697-3080</p> <p>United Kingdom TEL: +44-1-908-306700 FAX: +44-1-908-235788</p> <p>Denmark TEL: +45-3694-4739 FAX: +45-3694-4789</p> <p>Esopo TEL: +358-9725-54491 FAX: +358-9-7255-4499</p> <p>Salo TEL: +358-2-7332234 FAX: +358-2-7332237</p> <p>Oulu TEL: +358-8-5372930 FAX: +358-8-5372931</p> <p>Barcelona TEL: +34-9375-24320 FAX: +34-9375-24410</p> <p>Hungary TEL: +36-1-4719338 FAX: +36-1-4719339</p> <p>Poland TEL: +48-22-575213 FAX: +48-22-5757001</p> <p>Russia TEL: +7-495-739-4174 FAX: +7-495-739-4174</p> <p>Seoul TEL: +82-2-8182-700 FAX: +82-2-8182-715</p> <p>Masan TEL: +82-55-240-6234 FAX: +82-55-240-6236</p> <p>Dalian TEL: +86-411-8230-8549 FAX: +86-411-8230-8537</p> <p>Beijing TEL: +86-10-8525-2483 FAX: +86-10-8525-2489</p> | <p>Tianjin TEL: +86-22-23029181 FAX: +86-22-23029183</p> <p>Shanghai TEL: +86-21-6279-2727 FAX: +86-21-6247-2066</p> <p>Hangzhou TEL: +86-571-87658072 FAX: +86-571-87658071</p> <p>Nanjing TEL: +86-25-8689-0015 FAX: +86-25-8689-0393</p> <p>Ningbo TEL: +86-574-87654201 FAX: +86-574-87654208</p> <p>Qingdao TEL: +86-532-5779-312 FAX: +86-532-5779-653</p> <p>Suzhou TEL: +86-512-6807-1300 FAX: +86-512-6807-2300</p> <p>Wuxi TEL: +86-510-82702693 FAX: +86-510-82702992</p> <p>Shenzhen TEL: +86-755-8307-3008 FAX: +86-755-8307-3003</p> <p>Dongguan TEL: +86-769-8393-3320 FAX: +86-769-8398-4140</p> <p>Fuzhou TEL: +86-591-8801-8698 FAX: +86-591-8801-8690</p> <p>Guangzhou TEL: +86-20-3878-8100 FAX: +86-20-3825-5965</p> <p>Huizhou TEL: +86-752-205-1054 FAX: +86-752-205-1059</p> <p>Xiamen TEL: +86-592-238-5705 FAX: +86-592-239-8380</p> <p>Zhuhai TEL: +86-756-3232-480 FAX: +86-756-3232-460</p> <p>Hong Kong TEL: +852-2-740-6262 FAX: +852-2-375-8971</p> <p>Taipei TEL: +886-2-2500-6956 FAX: +886-2-2503-2869</p> <p>Kaohsiung TEL: +886-7-237-0881 FAX: +886-7-238-7332</p> <p>Singapore TEL: +65-6332-2322 FAX: +65-6332-5662</p> <p>Philippines TEL: +63-2-807-6872 FAX: +63-2-809-1422</p> <p>Thailand TEL: +66-2-254-4890 FAX: +66-2-256-6334</p> <p>Kuala Lumpur TEL: +60-3-7958-8355 FAX: +60-3-7958-8377</p> <p>Penang TEL: +60-4-2286453 FAX: +60-4-2286452</p> <p>Kyoto TEL: +81-75-365-1218 FAX: +81-75-365-1228</p> <p>Yokohama TEL: +81-45-476-2290 FAX: +81-45-476-2295</p> |
|---|--|

Excellence in Electronics



ROHM CO., LTD.

21 Saiin Mizosaki-cho, Ukyo-ku, Kyoto
615-8585, Japan
TEL: +81-75-311-2121 FAX: +81-75-315-0172
URL: <http://www.rohm.com>

Published by
KTC LSI Development Headquarters
LSI Business Promotion Group

Notes

No copying or reproduction of this document, in part or in whole, is permitted without the consent of ROHM CO.,LTD.

The content specified herein is subject to change for improvement without notice.

The content specified herein is for the purpose of introducing ROHM's products (hereinafter "Products"). If you wish to use any such Product, please be sure to refer to the specifications, which can be obtained from ROHM upon request.

Examples of application circuits, circuit constants and any other information contained herein illustrate the standard usage and operations of the Products. The peripheral conditions must be taken into account when designing circuits for mass production.

Great care was taken in ensuring the accuracy of the information specified in this document. However, should you incur any damage arising from any inaccuracy or misprint of such information, ROHM shall bear no responsibility for such damage.

The technical information specified herein is intended only to show the typical functions of and examples of application circuits for the Products. ROHM does not grant you, explicitly or implicitly, any license to use or exercise intellectual property or other rights held by ROHM and other parties. ROHM shall bear no responsibility whatsoever for any dispute arising from the use of such technical information.

The Products specified in this document are intended to be used with general-use electronic equipment or devices (such as audio visual equipment, office-automation equipment, communication devices, electronic appliances and amusement devices).

The Products are not designed to be radiation tolerant.

While ROHM always makes efforts to enhance the quality and reliability of its Products, a Product may fail or malfunction for a variety of reasons.

Please be sure to implement in your equipment using the Products safety measures to guard against the possibility of physical injury, fire or any other damage caused in the event of the failure of any Product, such as derating, redundancy, fire control and fail-safe designs. ROHM shall bear no responsibility whatsoever for your use of any Product outside of the prescribed scope or not in accordance with the instruction manual.

The Products are not designed or manufactured to be used with any equipment, device or system which requires an extremely high level of reliability the failure or malfunction of which may result in a direct threat to human life or create a risk of human injury (such as a medical instrument, transportation equipment, aerospace machinery, nuclear-reactor controller, fuel-controller or other safety device). ROHM shall bear no responsibility in any way for use of any of the Products for the above special purposes. If a Product is intended to be used for any such special purpose, please contact a ROHM sales representative before purchasing.

If you intend to export or ship overseas any Product or technology specified herein that may be controlled under the Foreign Exchange and the Foreign Trade Law, you will be required to obtain a license or permit under the Law.

Thank you for your accessing to ROHM product informations.

More detail product informations and catalogs are available, please contact your nearest sales office.

ROHM Customer Support System

THE AMERICAS / EUROPE / ASIA / JAPAN

www.rohm.com

Contact us : webmaster@rohm.co.jp