



3.3V 1M x 18 Flow-through synchronous SRAM

Features

- Organization: 1,048,576 words x18 bits
- Fast clock to data access: 8.5/10 ns
- Fast \overline{OE} access time: 3.4/3.8 ns
- Fully synchronous flow-through operation
- Asynchronous output enable control
- Available 100-pin TQFP and 165-ball BGA packages
- Individual byte write and global write
- Multiple chip enables for easy expansion
- 3.3 V core power supply
- 2.5 V or 3.3V I/O operation with separate V_{DDQ}
- Linear or interleaved burst control
- Snooze mode for reduced power-standby
- Boundary scan using IEEE 1149.1 JTAG function
- NTD™¹ flow-through architecture available (AS7C331MNTD18A, AS7C33512NTD32A/AS7C33512NTD36A)

¹ NTD™ is a trademark of Alliance Semiconductor Corporation. All trademarks mentioned in this document are the property of their respective owners

Logic block diagram

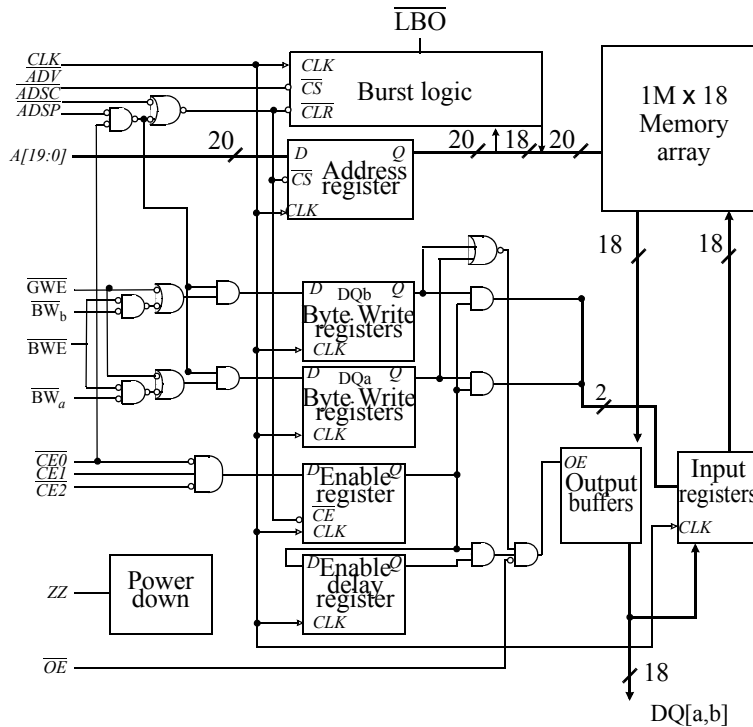

Selection guide

	-85	-10	Units
Minimum cycle time	10	12	ns
Maximum clock access time	8.5	10	ns
Maximum operating current	250	230	mA
Maximum standby current	85	75	mA
Maximum CMOS standby current (DC)	40	40	mA



Pin and ball designations



Pin configuration for 100-pin TQFP

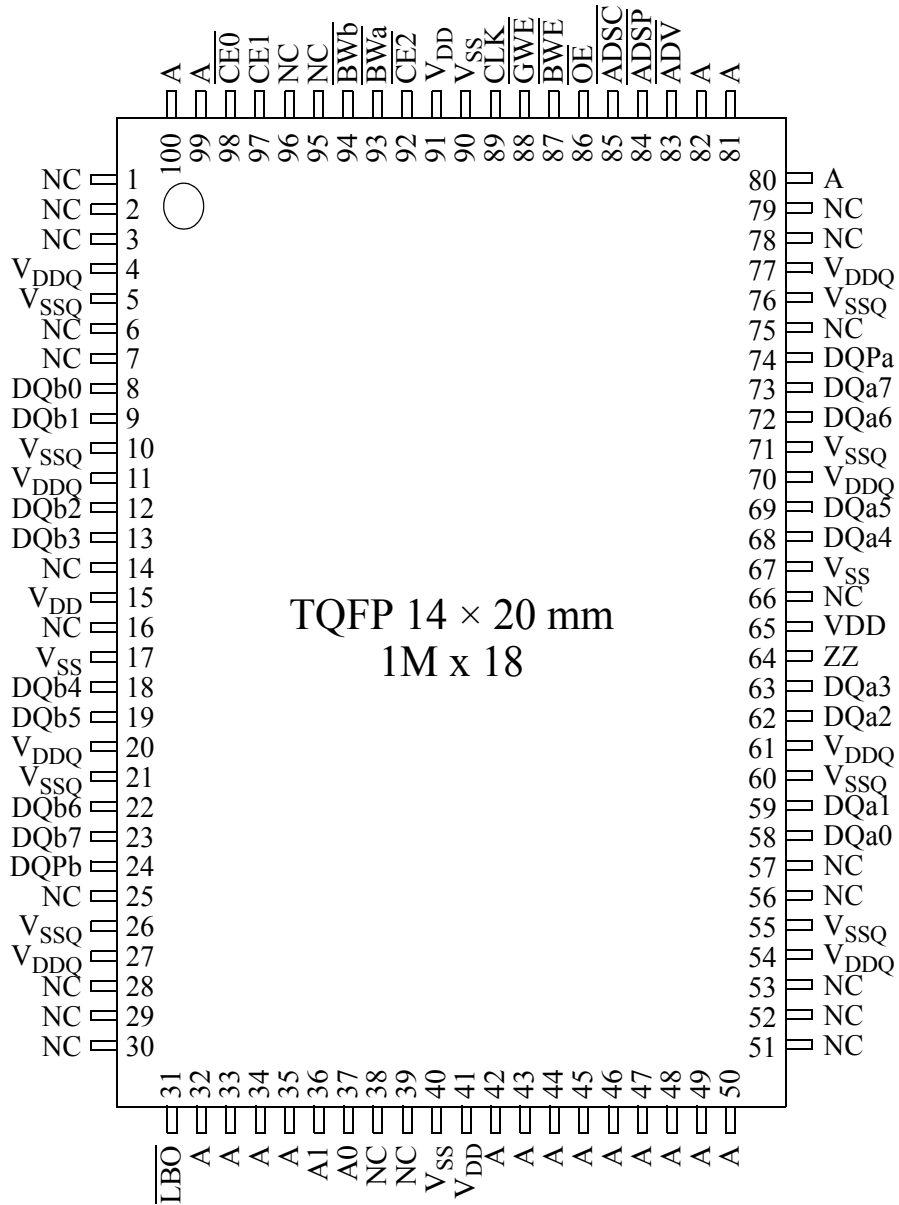



Ball assignments for 165-ball BGA

	1	2	3	4	5	6	7	8	9	10	11
A	NC	A	$\overline{\text{CE0}}$	$\overline{\text{BWb}}$	NC	$\overline{\text{CE2}}$	$\overline{\text{BWE}}$	$\overline{\text{ADSC}}$	$\overline{\text{ADV}}$	A	A
B	NC	A	CE1	NC	$\overline{\text{BWa}}$	CLK	$\overline{\text{GWE}}$	$\overline{\text{OE}}$	$\overline{\text{ADSP}}$	A	NC
C	NC	NC	VDDQ	VSS	VSS	VSS	VSS	VSS	VDDQ	NC	DQP _a
D	NC	DQ _b	VDDQ	VDD	VSS	VSS	VSS	VDD	VDDQ	NC	DQ _a
E	NC	DQ _b	VDDQ	VDD	VSS	VSS	VSS	VDD	VDDQ	NC	DQ _a
F	NC	DQ _b	VDDQ	VDD	VSS	VSS	VSS	VDD	VDDQ	NC	DQ _a
G	NC	DQ _b	VDDQ	VDD	VSS	VSS	VSS	VDD	VDDQ	NC	DQ _a
H	NC	NC	NC	VDD	VSS	VSS	VSS	VDD	NC	NC	ZZ
J	DQ _b	NC	VDDQ	VDD	VSS	VSS	VSS	VDD	VDDQ	DQ _a	NC
K	DQ _b	NC	VDDQ	VDD	VSS	VSS	VSS	VDD	VDDQ	DQ _a	NC
L	DQ _b	NC	VDDQ	VDD	VSS	VSS	VSS	VDD	VDDQ	DQ _a	NC
M	DQ _b	NC	VDDQ	VDD	VSS	VSS	VSS	VDD	VDDQ	DQ _a	NC
N	DQP _b	NC	VDDQ	VSS	NC	A	NC	VSS	VDDQ	NC	NC
P	NC	NC	A	A	TDI	A1 ¹	TDO	A	A	A	A
R	$\overline{\text{LBO}}$	NC	A	A	TMS	A0 ¹	TCK	A	A	A	A

¹ A0 and A1 are the two least significant bits (LSB) of the address field and set the internal burst counter if burst is desired.



Functional description

The AS7C331MFT18A is a high-performance CMOS 16-Mbit synchronous Static Random Access Memory (SRAM) device organized as 1,048,576 words x18 bits.

Fast cycle times of 10/12 ns with clock access times (t_{CD}) of 8.5/10 ns. Three chip enable (\overline{CE}) inputs permit easy memory expansion. Burst operation is initiated in one of two ways: the controller address strobe (\overline{ADSC}), or the processor address strobe (\overline{ADSP}). The burst advance pin (\overline{ADV}) allows subsequent internally generated burst addresses.

Read cycles are initiated with \overline{ADSP} (regardless of \overline{WE} and \overline{ADSC}) using the new external address clocked into the on-chip address register when \overline{ADSP} is sampled LOW, the chip enables are sampled active, and the output buffer is enabled with \overline{OE} . In a read operation, the data accessed by the current address registered in the address registers by the positive edge of CLK is carried to the data-out buffers. \overline{ADV} is ignored on the clock edge that samples \overline{ADSP} asserted, but it is sampled on all subsequent clock edges. Address is incremented internally for the next access of the burst when \overline{ADV} is sampled LOW and both address strobes are HIGH. Burst mode is selectable with the \overline{LBO} input. With \overline{LBO} unconnected or driven HIGH, burst operations use an interleaved count sequence. With \overline{LBO} driven LOW, the device uses a linear count sequence.

Write cycles are performed by disabling the output buffers with \overline{OE} and asserting a write command. A global write enable \overline{GWE} writes all 18 bits regardless of the state of individual $\overline{BW[a,b]}$ inputs. Alternately, when \overline{GWE} is HIGH, one or more bytes may be written by asserting \overline{BWE} and the appropriate individual byte \overline{BWn} signals.

\overline{BWn} is ignored on the clock edge that samples \overline{ADSP} LOW, but it is sampled on all subsequent clock edges. Output buffers are disabled when \overline{BWn} is sampled LOW, regardless of \overline{OE} . Data is clocked into the data input register when \overline{BWn} is sampled LOW. Address is incremented internally to the next burst address if \overline{BWn} and \overline{ADV} are sampled LOW.

Read or write cycles may also be initiated with \overline{ADSC} instead of \overline{ADSP} . The differences between cycles initiated with \overline{ADSC} and \overline{ADSP} follow.

\overline{ADSP} must be sampled HIGH when \overline{ADSC} is sampled LOW to initiate a cycle with \overline{ADSC} .

\overline{WE} signals are sampled on the clock edge that samples \overline{ADSC} LOW (and \overline{ADSP} HIGH).

Master chip enable $\overline{CE0}$ blocks \overline{ADSP} , but not \overline{ADSC} .

The AS7C331MFT18A family operates from a core 3.3V power supply. I/Os use a separate power supply that can operate at 2.5V or 3.3V. These devices are available in a 100-pin TQFP and 165-ball BGA.

TQFP and BGA capacitance

Parameter	Symbol	Test conditions	Min	Max	Unit
Input capacitance	C_{IN}	$V_{IN} = 0V$	-	5	pF
I/O capacitance	$C_{I/O}$	$V_{IN} = V_{OUT}$	-	7	pF

TQFP and BGA thermal resistance

Description	Symbol	Typical	Units	Conditions
Thermal resistance (junction to ambient) ¹	1 layer	θ_{JA}	40	$^{\circ}C/W$
	4 layer	θ_{JA}	22	$^{\circ}C/W$
Thermal resistance (junction to top of case) ¹	θ_{JC}	8	$^{\circ}C/W$	Test conditions follow standard test methods and procedures for measuring thermal impedance, per EIA/JESD51

¹ This parameter is sampled.



Signal descriptions

Signal	I/O	Properties	Description
CLK	I	CLOCK	Clock. All inputs except OE, ZZ, and LBO are synchronous to this clock.
A, A0, A1	I	SYNC	Address. Sampled when all chip enables are active and when ADSC or ADSP are asserted.
DQ[a,b]	I/O	SYNC	Data. Driven as output when the chip is enabled and when OE is active.
$\overline{CE0}$	I	SYNC	Master chip enable. Sampled on clock edges when ADSP or ADSC is active. When $\overline{CE0}$ is inactive, ADSP is blocked. Refer to the "Synchronous truth table" for more information.
CE1, $\overline{CE2}$	I	SYNC	Synchronous chip enables. Active high and active LOW, respectively. Sampled on clock edges when ADSC is active or when $\overline{CE0}$ and ADSP are active.
\overline{ADSP}	I	SYNC	Address strobe processor. Asserted LOW to load a new bus address or to enter standby mode.
\overline{ADSC}	I	SYNC	Address strobe controller. Asserted LOW to load a new address or to enter standby mode.
\overline{ADV}	I	SYNC	Advance. Asserted LOW to continue burst read/write.
\overline{GWE}	I	SYNC	Global write enable. Asserted LOW to write all 32/36 and 18 bits. When HIGH, BWE and BW[a,b] control write enable.
\overline{BWE}	I	SYNC	Byte write enable. Asserted LOW with \overline{GWE} HIGH to enable effect of BW[a,b] inputs.
$\overline{BW[a,b]}$	I	SYNC	Write enables. Used to control write of individual bytes when \overline{GWE} is HIGH and \overline{BWE} is LOW. If any of $\overline{BW[a,b]}$ is active with \overline{GWE} HIGH and \overline{BWE} LOW, the cycle is a write cycle. If all $\overline{BW[AB]}$ are inactive, the cycle is a read cycle.
\overline{OE}	I	ASYNCR	Asynchronous output enable. I/O pins are driven when \overline{OE} is active and the chip is in read mode.
\overline{LBO}	I	STATIC	Selects Burst mode. When tied to V_{DD} or left floating, device follows interleaved Burst order. When driven LOW, device follows linear Burst order. <i>This signal is internally pulled HIGH.</i>
TDO	O	SYNC	Serial data-out to the JTAG circuit. Delivers data on the negative edge of TCK (BGA only).
TDI	I	SYNC	Serial data-in to the JTAG circuit. Sampled on the rising edge of TCK (BGA only).
TMS	I	SYNC	This pin controls the Test Access Port state machine. Sampled on the rising edge of TCK (BGA only).
TCK	O	SYNC	Serial data-out to the JTAG circuit. Delivers data on the negative edge of TCK (BGA only).
ZZ	I	ASYNCR	Sleep. Places device in low power mode; data is retained. Connect to GND if unused.
NC	-	-	No connects

Write enable truth table (per byte)

Function	\overline{GWE}	\overline{BWE}	\overline{BWa}	\overline{BWb}
Write all bytes (a, b)	L	X	X	X
	H	L	L	L
Write byte a	H	L	L	H
Write byte b	H	L	H	L
Read	H	H	X	X
	H	L	H	H

Key: X = don't care; L = low; H = high; \overline{BWE} , \overline{BWn} = internal write signal



Burst sequence table

Interleaved burst address					Linear burst address				
	A1 A0	A1 A0	A1 A0	A1 A0		A1 A0	A1 A0	A1 A0	A1 A0
1 st Address	0 0	0 1	1 0	1 1	1 st Address	0 0	0 1	1 0	1 1
2 nd Address	0 1	0 0	1 1	1 0	2 nd Address	0 1	1 0	1 1	0 0
3 rd Address	1 0	1 1	0 0	0 1	3 rd Address	1 0	1 1	0 0	0 1
4 th Address	1 1	1 0	0 1	0 0	4 th Address	1 1	1 0	0 1	1 0

Synchronous truth table

$\overline{CE0}^1$	CE1	$\overline{CE2}$	\overline{ADSP}	\overline{ADSC}	\overline{ADV}	$\overline{WRITE}^{[2]}$	\overline{OE}	Address accessed	CLK	Operation	DQ
H	X	X	X	L	X	X	X	NA	L to H	Deselect	Hi-Z
L	L	X	L	X	X	X	X	NA	L to H	Deselect	Hi-Z
L	L	X	H	L	X	X	X	NA	L to H	Deselect	Hi-Z
L	X	H	L	X	X	X	X	NA	L to H	Deselect	Hi-Z
L	X	H	H	L	X	X	X	NA	L to H	Deselect	Hi-Z
L	H	L	L	X	X	X	L	External	L to H	Begin read	Q
L	H	L	L	X	X	X	H	External	L to H	Begin read	Hi-Z
L	H	L	H	L	X	H	L	External	L to H	Begin read	Q
L	H	L	H	L	X	H	H	External	L to H	Begin read	Hi-Z
X	X	X	H	H	L	H	L	Next	L to H	Continue read	Q
X	X	X	H	H	L	H	H	Next	L to H	Continue read	Hi-Z
X	X	X	H	H	H	H	L	Current	L to H	Suspend read	Q
X	X	X	H	H	H	H	H	Current	L to H	Suspend read	Hi-Z
H	X	X	X	H	L	H	L	Next	L to H	Continue read	Q
H	X	X	X	H	L	H	H	Next	L to H	Continue read	Hi-Z
H	X	X	X	H	H	H	L	Current	L to H	Suspend read	Q
H	X	X	X	H	H	H	H	Current	L to H	Suspend read	Hi-Z
L	H	L	H	L	X	L	X	External	L to H	Begin write	D ³
X	X	X	H	H	L	L	X	Next	L to H	Continue write	D
H	X	X	X	H	L	L	X	Next	L to H	Continue write	D
X	X	X	H	H	H	L	X	Current	L to H	Suspend write	D
H	X	X	X	H	H	L	X	Current	L to H	Suspend write	D

1 X = don't care, L = low, H = high

2 For \overline{WRITE} , L means any one or more byte write enable signals (\overline{BWA} , \overline{BWB} , \overline{BWC} or \overline{BWD}) and \overline{BWE} are LOW or \overline{GWE} is LOW. \overline{WRITE} = HIGH for all \overline{BWx} , \overline{BWE} , \overline{GWE} HIGH. See "Write enable truth table (per byte)," on page 6 for more information.

3 For write operation following a READ, \overline{OE} must be HIGH before the input data set up time and held HIGH throughout the input hold time



Absolute maximum ratings

Parameter	Symbol	Min	Max	Unit
Power supply voltage relative to GND	V_{DD}, V_{DDQ}	-0.5	+4.6	V
Input voltage relative to GND (input pins)	V_{IN}	-0.5	$V_{DD} + 0.5$	V
Input voltage relative to GND (I/O pins)	V_{IN}	-0.5	$V_{DDQ} + 0.5$	V
Power dissipation	P_D	-	1.8	W
DC output current	I_{OUT}	-	20 mA	mA
Storage temperature (plastic)	T_{stg}	-65	+150	°C
Temperature under bias	T_{bias}	-65	+135	°C

Note: Stresses greater than those listed in this table may cause permanent damage to the device. This is a stress rating only, and functional operation of the device at these or any other conditions outside those indicated in the operational sections of this specification is not implied. Exposure to absolute maximum rating conditions may affect reliability.

Recommended operating conditions at 3.3V I/O

Parameter	Symbol	Min	Nominal	Max	Unit
Supply voltage for inputs	V_{DD}	3.135	3.3	3.465	V
Supply voltage for I/O	V_{DDQ}	3.135	3.3	3.465	V
Ground supply	V_{SS}	0	0	0	V

Recommended operating conditions at 2.5V I/O

Parameter	Symbol	Min	Nominal	Max	Unit
Supply voltage for inputs	V_{DD}	3.135	3.3	3.465	V
Supply voltage for I/O	V_{DDQ}	2.375	2.5	2.625	V
Ground supply	V_{SS}	0	0	0	V

DC electrical characteristics for 3.3V I/O operation

Parameter	Sym	Conditions	Min	Max	Unit
Input leakage current ¹	$ I_{LI} $	$V_{DD} = \text{Max}, 0V \leq V_{IN} \leq V_{DD}$	-2	2	μA
Output leakage current	$ I_{LO} $	$OE \geq V_{IH}, V_{DD} = \text{Max}, 0V \leq V_{OUT} \leq V_{DDQ}$	-2	2	μA
Input high (logic 1) voltage	V_{IH}	Address and control pins	2	$V_{DD}+0.3$	V
		I/O pins	2	$V_{DDQ}+0.3$	
Input low (logic 0) voltage	V_{IL}	Address and control pins	-0.3*	0.8	V
		I/O pins	-0.5*	0.8	
Output high voltage	V_{OH}	$I_{OH} = -4 \text{ mA}, V_{DDQ} = 3.135\text{V}$	2.4	-	V
Output low voltage	V_{OL}	$I_{OL} = 8 \text{ mA}, V_{DDQ} = 3.465\text{V}$	-	0.4	V

¹ $\overline{LB0}$, and ZZ pins and the 165 BGA JTAG pins (TMS, TDI, and TCK) have an internal pull-up or pull-down, and input leakage = $\pm 10 \mu\text{A}$.



DC electrical characteristics for 2.5V I/O operation

Parameter	Sym	Conditions	Min	Max	Unit
Input leakage current	$ I_{LI} $	$V_{DD} = \text{Max}, 0V \leq V_{IN} \leq V_{DD}$	-2	2	μA
Output leakage current	$ I_{LO} $	$OE \geq V_{IH}, V_{DD} = \text{Max}, 0V \leq V_{OUT} \leq V_{DDQ}$	-2	2	μA
Input high (logic 1) voltage	V_{IH}	Address and control pins	1.7	$V_{DD}+0.3$	V
		I/O pins	1.7	$V_{DDQ}+0.3$	V
Input low (logic 0) voltage	V_{IL}	Address and control pins	-0.3*	0.7	V
		I/O pins	-0.3*	0.7	V
Output high voltage	V_{OH}	$I_{OH} = -4 \text{ mA}, V_{DDQ} = 2.375V$	1.7	-	V
Output low voltage	V_{OL}	$I_{OL} = 8 \text{ mA}, V_{DDQ} = 2.625V$	-	0.7	V

* V_{IL} min = -1.5 for pulse width less than $0.2 \times t_{CYC}$

I_{DD} operating conditions and maximum limits

Parameter	Sym	Conditions	-85	-10	Unit
Operating power supply current ¹	I_{CC}	$\overline{CE0} = V_{IL}, CE1 = V_{IH}, \overline{CE2} = V_{IL}, f = f_{Max}, I_{OUT} = 0 \text{ mA}$	250	230	mA
Standby power supply current	I_{SB}	Deselected, $f = f_{Max}, ZZ \leq V_{IL}$	90	80	mA
	I_{SB1}	Deselected, $f = 0, ZZ \leq 0.2V$, all $V_{IN} \leq 0.2V$ or $\geq V_{DD} - 0.2V$	40	40	
	I_{SB2}	Deselected, $f = f_{Max}, ZZ \geq V_{DD} - 0.2V$, all $V_{IN} \leq V_{IL}$ or $\geq V_{IH}$	40	40	

¹ I_{CC} given with no output loading. I_{CC} increases with faster cycle times and greater output loading.



Timing characteristics over operating range

Parameter	Sym	-85		-10		Unit	Notes ¹
		Min	Max	Min	Max		
Cycle time	t _{CYC}	10	–	12	–	ns	
Clock access time	t _{CD}	–	8.5	–	10	ns	
Output enable low to data valid	t _{OE}	–	3.5	–	3.8	ns	
Clock high to output low Z	t _{LZC}	0	–	0	–	ns	2,3,4
Data output invalid from clock high	t _{OH}	3.0	–	3.0	–	ns	2
Output enable low to output low Z	t _{LZOE}	0	–	0	–	ns	2,3,4
Output enable high to output high Z	t _{HZOE}	–	3.5	–	3.8	ns	2,3,4
Clock high to output high Z	t _{HZC}	–	3.5	–	3.8	ns	2,3,4
Output enable high to invalid output	t _{OHOE}	0	–	0	–	ns	
Clock high pulse width	t _{CH}	2.4	–	2.4	–	ns	5
Clock low pulse width	t _{CL}	2.3	–	2.4	–	ns	5
Address setup to clock high	t _{AS}	1.5	–	1.5	–	ns	6
Data setup to clock high	t _{DS}	1.5	–	1.5	–	ns	6
Write setup to clock high	t _{WS}	1.5	–	1.5	–	ns	6,7
Chip select setup to clock high	t _{CSS}	1.5	–	1.5	–	ns	6,8
Address hold from clock high	t _{AH}	0.5	–	0.5	–	ns	6
Data hold from clock high	t _{DH}	0.5	–	0.5	–	ns	6
Write hold from clock high	t _{WH}	0.5	–	0.5	–	ns	6,7
Chip select hold from clock high	t _{CSH}	0.5	–	0.5	–	ns	6,8
$\overline{\text{ADV}}$ setup to clock high	t _{ADVS}	1.5	–	1.5	–	ns	6
$\overline{\text{ADSP}}$ setup to clock high	t _{ADSPS}	1.5	–	1.5	–	ns	6
$\overline{\text{ADSC}}$ setup to clock high	t _{ADSCS}	1.5	–	1.5	–	ns	6
$\overline{\text{ADV}}$ hold from clock high	t _{ADVH}	0.5	–	0.5	–	ns	6
$\overline{\text{ADSP}}$ hold from clock high	t _{ADSPH}	0.5	–	0.5	–	ns	6
$\overline{\text{ADSC}}$ hold from clock high	t _{ADSCH}	0.5	–	0.5	–	ns	6

¹ See “Notes” on page 21.



IEEE 1149.1 serial boundary scan (JTAG)

The SRAM incorporates a serial boundary scan test access port (TAP). The port operates in accordance with IEEE Standard 1149.1-1990 but does not have the set of functions required for full 1149.1 compliance. The inclusion of these functions would place an added delay in the critical speed path of the SRAM. The TAP controller functionality does not conflict with the operation of other devices using 1149.1 fully compliant TAPs. It uses JEDEC-standard 2.5V I/O logic levels. The SRAM contains a TAP controller, instruction register, boundary scan register, bypass register, and ID register.

Disabling the JTAG feature

If the JTAG function is not being implemented, TCK should be tied to VSS, TMS and TDI can be left unconnected. At power-up, the device will come up in a reset state which will not interfere with the operation of the device. TDO should be left unconnected.

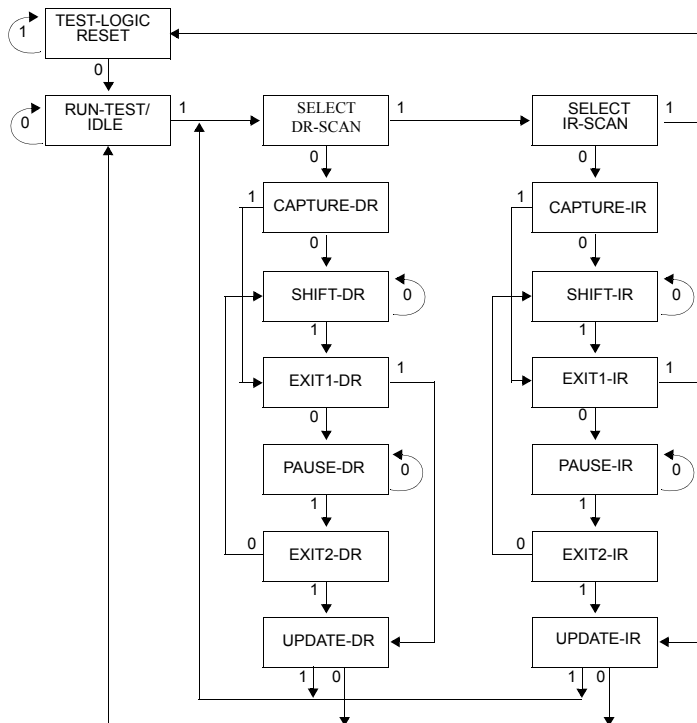

Note: The 0 or 1 next to each state represents the value of TMS at the rising edge of TCK.

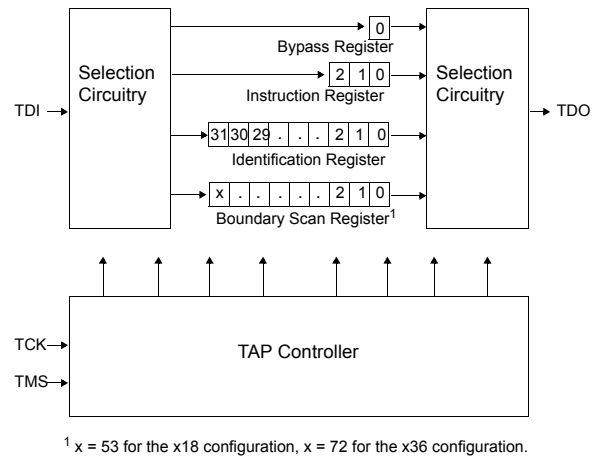

Test access port (TAP)

Test clock (TCK)

The test clock is used with only the TAP controller. All inputs are captured on the rising edge of TCK. All outputs are driven from the falling edge of TCK.

Test mode select (TMS)

The TAP controller receives commands from TMS input. It is sampled on the rising edge of TCK. You can leave this pin/ball unconnected if the TAP is not used. The pin/ball is pulled up internally, resulting in a logic high level.

Test data-in (TDI)

The TDI pin/ball serially inputs information into the registers and can be connected to the input of any of the registers. The register between TDI and TDO is chosen by the instruction that is loaded into the TAP instruction register. For information on loading the instruction register, see the TAP Controller State Diagram. TDI is internally pulled up and can be unconnected if the TAP is unused in an application. TDI is connected to the most significant bit (MSB) of any register. (See the TAP Controller Block Diagram.)



Test data-out (TDO)

The TDO output pin/ball serially clocks data-out from the registers. The output is active depending upon the current state of the TAP state machine. The output changes on the falling edge of TCK. TDO is connected to the least significant bit (LSB) of any register. (See the TAP Controller State Diagram.)

Performing a TAP RESET

You can perform a RESET by forcing TMS high (V_{DD}) for five rising edges of TCK. This RESET does not affect the operation of the SRAM and can be performed while the SRAM is operating.

TAP registers

Registers are connected between the TDI and TDO pins/balls. They allow data to be scanned into and out of the SRAM test circuitry. Only one register can be selected at a time through the instruction register. Data is serially loaded into the TDI pin/ball on the rising edge of TCK. Data is output on the TDO pin/ball on the falling edge of TCK.

Instruction register

You can serially load three-bit instructions into the instruction register. The register is loaded when it is placed between the TDI and TDO pins/balls as shown in the TAP Controller Block Diagram. The instruction register is loaded with the IDCODE instruction at power up and also if the controller is placed in a reset state, as described in the previous section.

When the TAP controller is in the Capture-IR state, the two least significant bits are loaded with a binary “01” pattern to allow for fault isolation of the board-level series test data path.

Bypass register

To save time when serially shifting data through registers, it is sometimes advantageous to skip certain chips. The bypass register is a single-bit register that can be placed between the TDI and TDO pins/balls. This allows data to be shifted through the SRAM with minimal delay. The bypass register is set low (V_{ss}) when the BYPASS instruction is executed.

Boundary scan register

The boundary scan register is connected to all the input and bidirectional pins/balls on the SRAM. The x36 configuration has a 72-bit-long register and the x18 configuration has a 53-bit-long register.

The boundary scan register is loaded with the contents of the RAM I/O ring when the TAP controller is in the Capture-DR state and is then placed between the TDI and TDO pins/balls when the controller is moved to the Shift-DR state. The EXTEST, SAMPLE/RELOAD, and SAMPLE Z instructions can be used to capture the contents of the I/O ring.

The boundary scan order table shows the order in which the bits are connected. Each bit corresponds to one of the bumps on the SRAM package. The most significant bit (MSB) of the register is connected to TDI, and the least significant bit (LSB) is connected to TDO.

Identification (ID) register

The ID register has a vendor code and other information described in the Identification Register Definitions table. The ID register is loaded with a vendor-specific, 32-bit code during the Capture-DR state when the IDCODE command is loaded in the instruction register. The IDCODE is hardwired into the SRAM and can be shifted out when the TAP controller is in the Shift-DR state.

TAP instruction set

Eight different instructions are possible with the 3-bit instruction register. All combinations are listed in the Instruction Codes table. Three of these instructions are reserved and should not be used.



Note that the TAP controller used in this SRAM is not fully compliant to the 1149.1 convention because some of the mandatory 1149.1 instructions are not fully implemented. The TAP controller cannot be used to load address, data, or control signals into the SRAM and cannot preload the I/O buffers. The SRAM does not implement the 1149.1 commands EXTEST or INTEST or the PRELOAD portion of SAMPLE/PRELOAD. Instead, it performs a capture of the I/O ring when these instructions are executed.

Instructions are loaded into the TAP controller during the Shift-IR state when the instruction register is placed between TDI and TDO. During this state, instructions are shifted through the instruction register through the TDI and TDO pins/balls. To execute the instruction once it is shifted in, the TAP controller needs to be moved into the Update-IR state.

EXTEST

The EXTEST instruction, which executes whenever the instruction register is loaded with all 0s, is not implemented in this SRAM TAP controller. The TAP controller, however, does recognize an all-0 instruction. When an EXTEST instruction is loaded into the instruction register, the SRAM responds as if a SAMPLE/PRELOAD instruction has been loaded. Unlike the SAMPLE/PRELOAD instruction, EXTEST places the SRAM outputs in a high-Z state. EXTEST is a mandatory 1149.1 instruction. This device, therefore, is not compliant with 1149.1.

IDCODE

The IDCODE instruction is loaded into the instruction register upon power-up or whenever the TAP controller is given a test logic reset state. The IDCODE instruction causes a vendor-specific, 32-bit code to be loaded into the instruction register. It also places the instruction register between the TDI and TDO pins/balls and allows the IDCODE to be shifted out of the device when the TAP controller enters the Shift-DR state.

SAMPLE Z

The SAMPLE Z instruction causes the boundary scan register to be connected between the TDI and TDO pins/balls when the TAP controller is in a Shift-DR state. It also places all SRAM outputs into a high-Z state.

SAMPLE/PRELOAD

When the SAMPLE/PRELOAD instruction is loaded into the instruction register and the TAP controller is in the Capture-DR state, a snapshot of data on the inputs and bidirectional pins/balls is captured in the boundary scan register. Note that the SAMPLE/PRELOAD is a 1149.1 mandatory instruction, but the PRELOAD portion of this instruction is not implemented in this device. The TAP controller, therefore, is not fully 1149.1 compliant.

Be aware that the TAP controller clock can operate only at a frequency up to 10 Mhz, while the SRAM clock operates more than an order of magnitude faster. Because there is a large difference in the clock frequencies, it is possible that during the Capture-DR state, an input or output can undergo a transition. The TAP may then try to capture a signal while in transition (metastable state). This will not harm the device, but there is no guarantee as to the value that will be captured. Repeatable results may not be possible.

To guarantee that the boundary scan register captures the correct value of a signal, the SRAM signal must be stabilized long enough to meet the TAP controller's capture setup plus hold time (t_{CS} plus t_{CH}). The SRAM clock input might not be captured correctly if there is no way in a design to stop (or slow) the clock during a SAMPLE/PRELOAD instruction. If this is an issue, it is possible to capture all other signals and ignore the value of the CK and CK# captured in the boundary scan register. Once the data is captured, it is possible to shift out the data by putting the TAP into the Shift-DR state. This places the boundary scan register between the TDI and TDO pins.

Note that since the PRELOAD part of the command is not implemented, putting the TAP to the Update-DR state while performing a SAMPLE/PRELOAD instruction will have the same effect as the Pause-DR command.

BYPASS

The advantage of the BYPASS instruction is that it shortens the boundary scan path when multiple devices are connected together on a board. When the BYPASS instruction is loaded in the instruction register and the TAP is placed in a Shift-DR state, the bypass register is placed between TDI and TDO.



Reserved

Do not use a reserved instruction. These instructions are not implemented but are reserved for future use.

TAP timing diagram

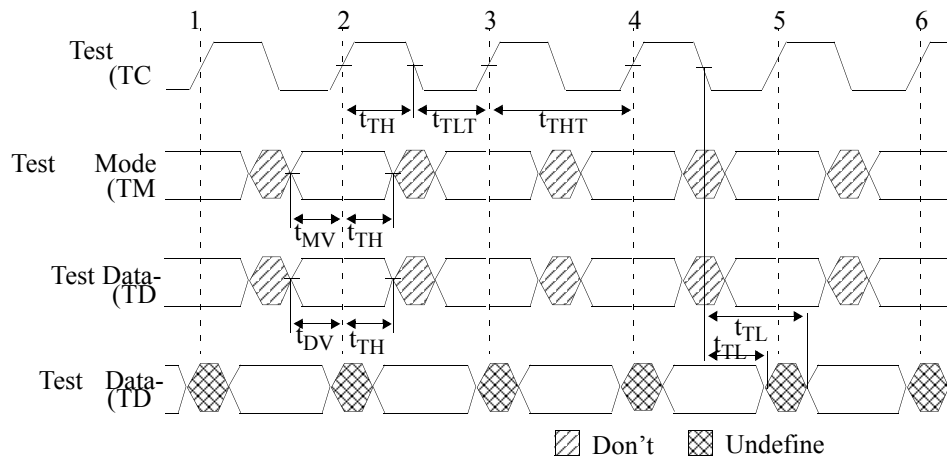

TAP AC electrical characteristics

For notes 1 and 2, $+10^{\circ}\text{C} \leq T_J \leq +110^{\circ}\text{C}$ and $+2.4\text{V} \leq V_{DD} \leq +2.6\text{V}$.

Description	Symbol	Min	Max	Units
Clock				
Clock cycle time	t_{THTH}	100		ns
Clock frequency	f_{TF}		10	MHz
Clock high time	t_{THTL}	40		ns
Clock low time	t_{TLTH}	40		ns
Output Times				
TCK low to TDO unknown	t_{TLOX}	0		ns
TCK low to TDO valid	t_{TLOV}		20	ns
TDI valid to TCK high	t_{DVTH}	10		ns
TCK high to TDI invalid	t_{THDX}	10		ns
Setup Times				
TMS setup	t_{MVTH}	10		ns
Capture setup	t_{CS}^1	10		ns
Hold Times				
TMS hold	t_{THMX}	10		ns
Capture hold	t_{CH}^1	10		ns

¹ t_{CS} and t_{CH} refer to the setup and hold time requirements of latching data from the boundary scan register.

² Test conditions are specified using the load in the figure TAP AC output load equivalent.



TAP AC test conditions

Input pulse levels. V_{SS} to 2.5V
 Input rise and fall times. 1 ns
 Input timing reference levels. 1.25V
 Output reference levels. 1.25V
 Test load termination supply voltage. . . . 1.25V

TAP AC output load equivalent

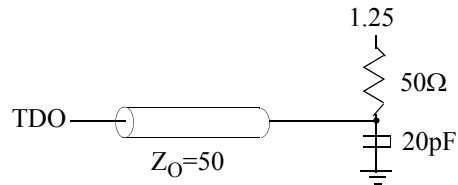

3.3V V_{DD} , TAP DC electrical characteristics and operating conditions

($+10^{\circ}\text{C} \leq T_J \leq +110^{\circ}\text{C}$ and $+3.135\text{V} \leq V_{DD} \leq +3.465\text{V}$ unless otherwise noted)

Description	Conditions	Symbol	Min	Max	Units	Notes
Input high (logic 1) voltage		V_{IH}	2.0	$V_{DD} + 0.3$	V	1, 2
Input low (logic 0) voltage		V_{IL}	-0.3	0.8	V	1, 2
Input leakage current	$0\text{V} \leq V_{IN} \leq V_{DD}$	IL_1	-5.0	5.0	μA	
Output leakage current	Outputs disabled, $0\text{V} \leq V_{IN} \leq V_{DDQ}(\text{DQx})$	IL_O	-5.0	5.0	μA	
Output low voltage	$I_{OLC} = 100\mu\text{A}$	V_{OL1}		0.7	V	1
Output low voltage	$I_{OLT} = 2\text{mA}$	V_{OL2}		0.8	V	1
Output high voltage	$I_{OHS} = -100\mu\text{A}$	V_{OH1}	2.9		V	1
Output high voltage	$I_{OHT} = -2\text{mA}$	V_{OH2}	2.0		V	1

2.5V V_{DD} , TAP DC electrical characteristics and operating conditions

($+10^{\circ}\text{C} \leq T_J \leq +110^{\circ}\text{C}$ and $+2.4\text{V} \leq V_{DD} \leq +2.6\text{V}$ unless otherwise noted)

Description	Conditions	Symbol	Min	Max	Units	Notes
Input high (logic 1) voltage		V_{IH}	1.7	$V_{DD} + 0.3$	V	1, 2
Input low (logic 0) voltage		V_{IL}	-0.3	0.7	V	1, 2
Input leakage current	$0\text{V} \leq V_{IN} \leq V_{DD}$	IL_1	-5.0	5.0	μA	
Output leakage current	Outputs disabled, $0\text{V} \leq V_{IN} \leq V_{DDQ}(\text{DQx})$	IL_O	-5.0	5.0	μA	
Output low voltage	$I_{OLC} = 100\mu\text{A}$	V_{OL1}		0.2	V	1
Output low voltage	$I_{OLT} = 2\text{mA}$	V_{OL2}		0.7	V	1
Output high voltage	$I_{OHS} = -100\mu\text{A}$	V_{OH1}	2.1		V	1
Output high voltage	$I_{OHT} = -2\text{mA}$	V_{OH2}	1.7		V	1

1. All voltage referenced to $V_{SS}(\text{GND})$.

2. Overshoot: $V_{IH}(\text{AC}) \leq V_{DD} + 1.5\text{V}$ for $t \leq t_{KHKH}/2$

Undershoot: $V_{IL}(\text{AC}) \geq -0.5$ for $t \leq t_{KHKH}/2$

Power-up: $V_{IH} \leq +2.6\text{V}$ and $V_{DD} \leq 2.4\text{V}$ and $V_{DDQ} \leq 1.4\text{V}$ for $t \leq 200\text{ms}$

During normal operation, V_{DDQ} must not exceed V_{DD} . Control input signals (such as $\overline{\text{LD}}$, $\text{R}/\overline{\text{W}}$, etc.) may not have pulsed widths less than $t_{KHKL}(\text{Min})$ or operate at frequencies exceeding $f_{KF}(\text{Max})$.



Identification register definitions

Instruction field	1M x 18	Description
Revision number (31:28)	xxxx	Reserved for version number.
Device depth (27:23)	xxxxx	Defines the depth of 1Mb words.
Device width (22:18)	xxxxx	Defines the width of x18 bits.
Device ID (17:12)	xxxxxx	Reserved for future use.
JEDEC ID code (11:1)	00001010010	Allows unique identification of SRAM vendor.
ID register presence indicator (0)	1	Indicates the presence of an ID register.

Scan register sizes

Register name	Bit size	
Instruction	3	
Bypass	1	
ID	32	
Boundary scan	x18:53	x36:72

Instruction codes

Instruction	Code	Description
EXTEST	000	Captures I/O ring contents. Places the boundary scan register between TDI and TDO. Forces all SRAM outputs to high-Z state. This instruction is not 1149.1-compliant.
IDCODE	001	Loads the ID register with the vendor ID code and places the register between TDI and TDO. This operation does not affect SRAM operations.
SAMPLE Z	010	Captures I/O ring contents. Places the boundary scan register between TDI and TDO. Forces all SRAM output drivers to a high-Z state.
Reserved	011	Do not use. This instruction is reserved for future use.
SAMPLE/ PRELOAD	100	Captures I/O ring contents. Places the boundary scan register between TDI and TDO. Does not affect SRAM operation. This instruction does not implement 1149.1 preload function and is therefore not 1149.1-compliant.
Reserved	101	Do not use. This instruction is reserved for future use.
Reserved	110	Do not use. This instruction is reserved for future use.
BYPASS	111	Places the bypass register between TDI and TDO. This operation does not affect SRAM operations.



165-ball BGA boundary exit order (x18)

Bit #s	Signal Name	Ball ID
1	SA0	6R
2	SA1	6P
3	SA	4P
4	SA	4R
5	SA	3R
6	SA	3P
7	LBO	1R
8	DQPb	1N
9	DQb	1M
10	DQb	1L
11	DQb	1K
12	DQb	1J
13	NC ¹	1H
14	DQb	2G
15	DQb	2F
16	DQb	2E
17	DQb	2D
18	SA	2B
19	SA	2A
20	CE0	3A
21	CE1	3B
22	BWb	4A
23	BWa	5B
24	CE2	6A
25	CLK	6B
26	GWE	7B
27	BWE	7A

Bit #s	Signal Name	Ball ID
28	OE	8B
29	ADSC	8A
30	ADSP	9B
31	ADV	9A
32	SA	10B
33	SA	10A
34	SA	11A
35	DQPa	11C
36	DQa	11D
37	DQa	11E
38	DQa	11F
39	DQa	11G
40	ZZ	11H
41	DQa	10J
42	DQa	10K
43	DQa	10L
44	DQa	10M
45	SA	11R
46	SA	10R
47	SA	10P
48	SA	9P
49	SA	9R
50	SA	8R
51	SA	8P
52	SA	6N
53	SA	11P

¹ NC is don't care



Key to switching waveforms

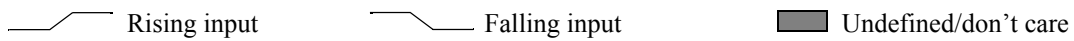

Timing waveform of read cycle

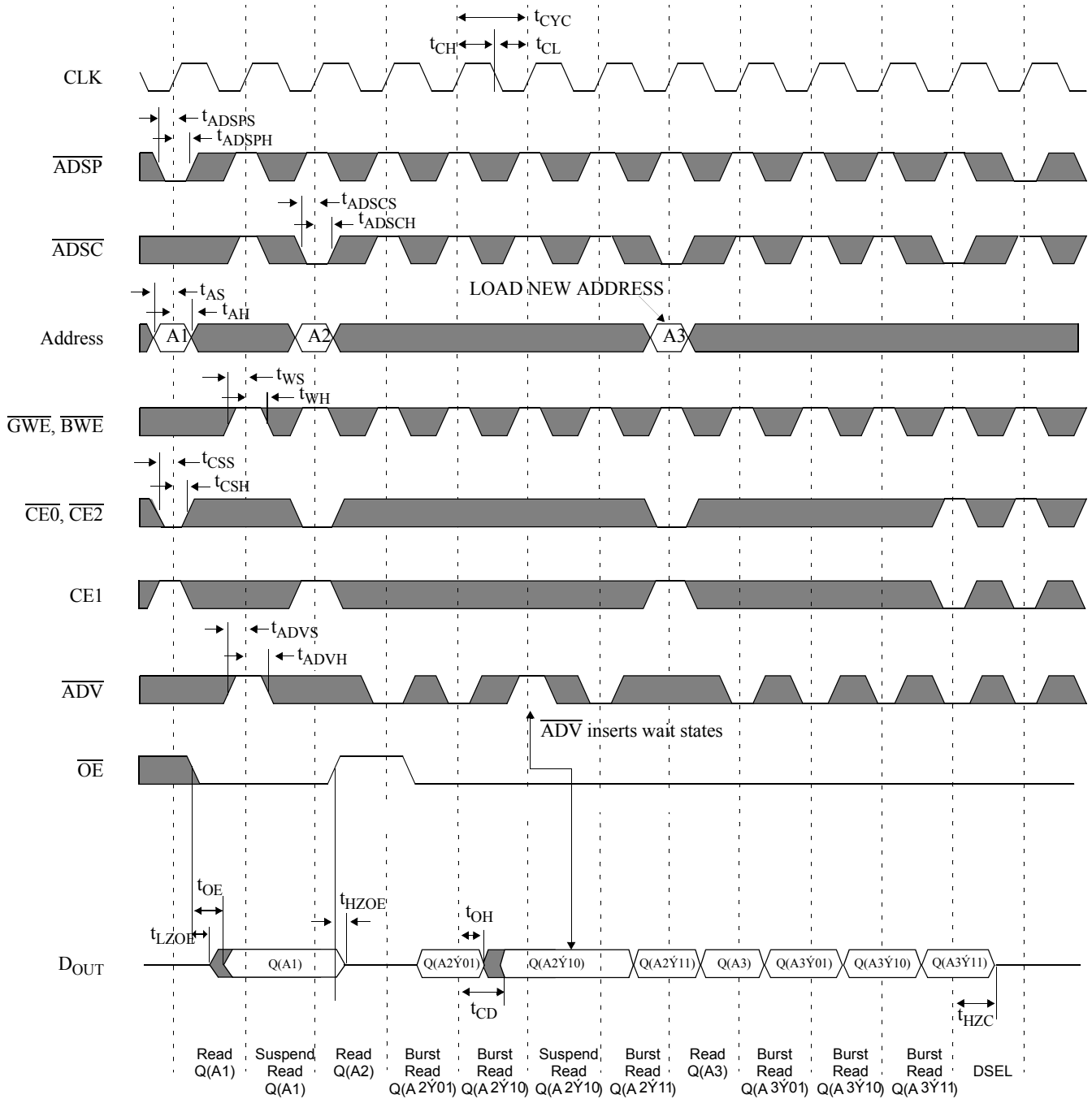

Note: $\dot{Y} = \text{XOR}$ when $\overline{\text{LBO}} = \text{high/no connect}$; $\dot{Y} = \text{ADD}$ when $\overline{\text{LBO}} = \text{low}$.
 $\overline{\text{BW}}[a:b]$ is don't care.



Timing waveform of write cycle

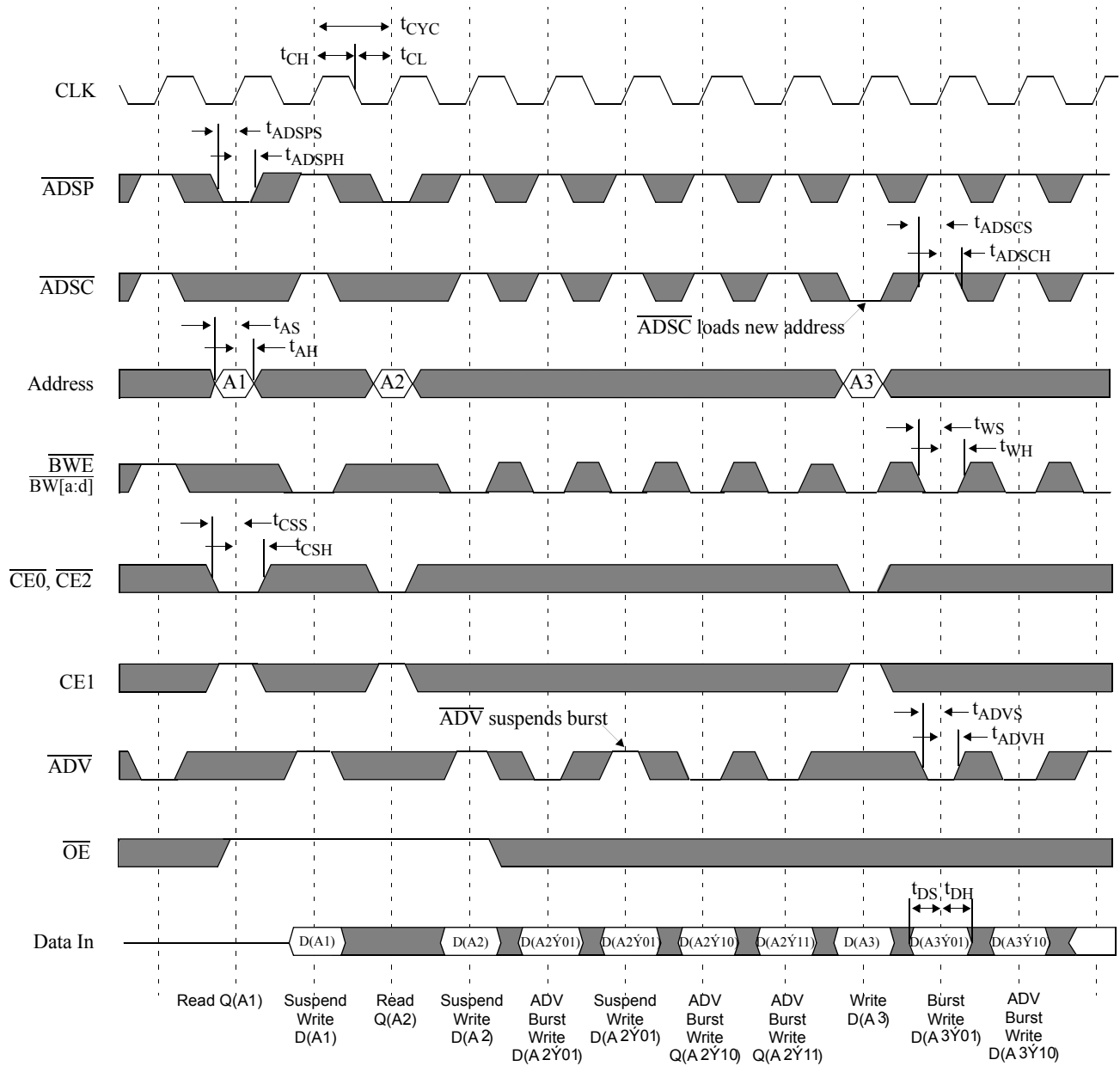

Note: \dot{Y} = XOR when \overline{LBO} = high/no connect; \dot{Y} = ADD when \overline{LBO} = low.



Timing waveform of read/write cycle

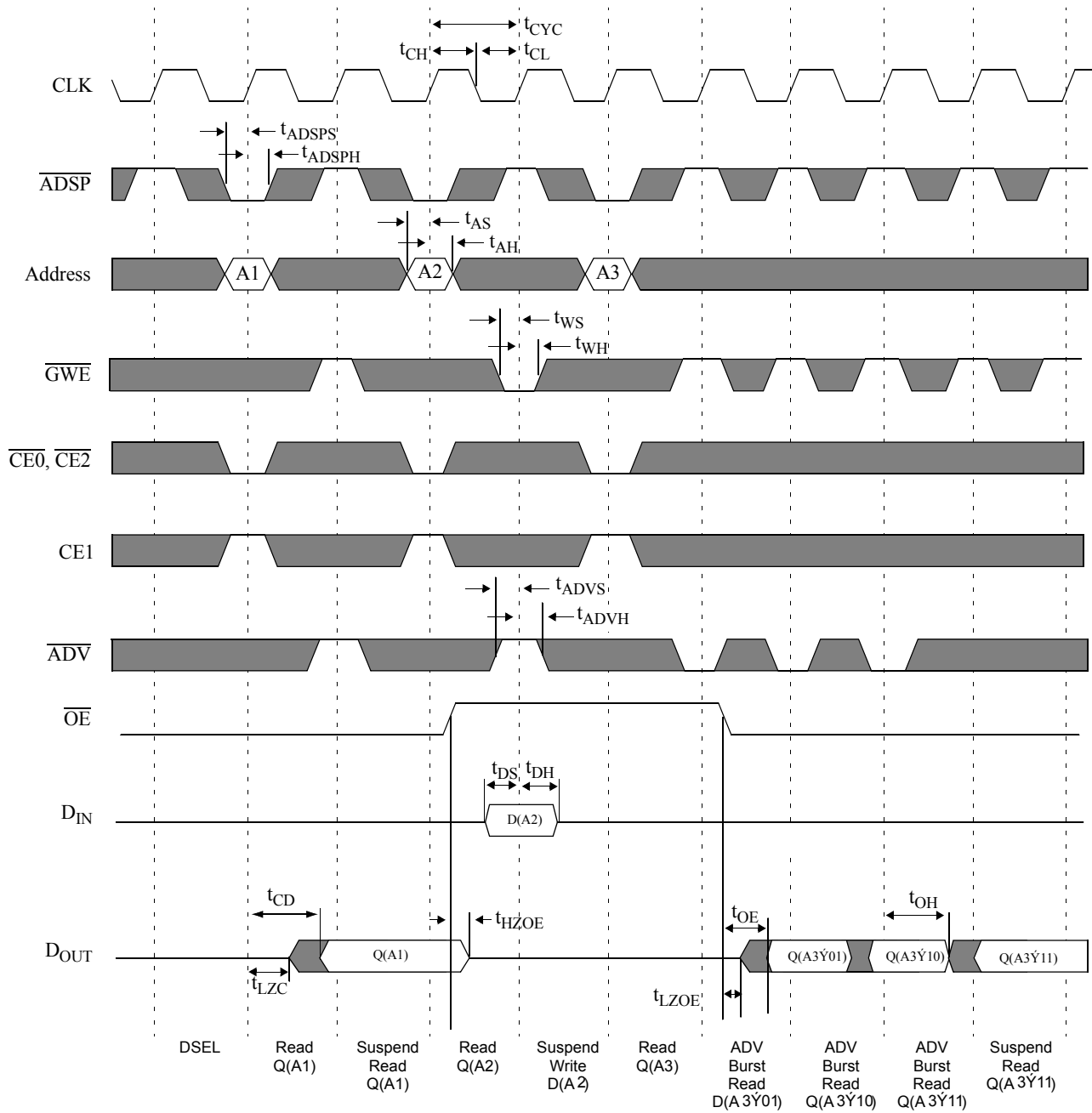

Note: \hat{Y} = XOR when $\overline{LB0}$ = high/no connect; \hat{Y} = ADD when $\overline{LB0}$ = low.



AC test conditions

- Output load: For t_{LZC} , t_{LZOE} , t_{HZOE} , t_{HZC} , see Figure C. For all others, see Figure B.
- Input pulse level: GND to 3V. See Figure A.
- Input rise and fall time (measured at 0.3V and 2.7V): 2 ns. See Figure A.
- Input and output timing reference levels: 1.5V.

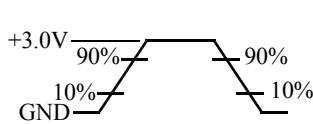

Figure A: Input waveform

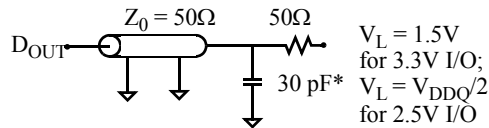

Figure B: Output load (A)

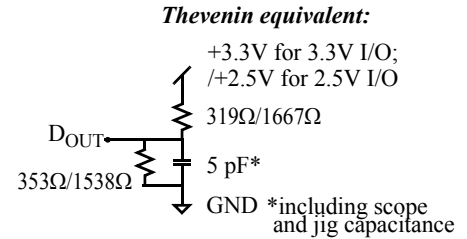

Figure C: Output load(B)

Notes

- 1 For test conditions, see “AC Test Conditions”, Figures A, B, and C.
- 2 This parameter is measured with output load condition in Figure C.
- 3 This parameter is sampled but not 100% tested.
- 4 t_{HZOE} is less than t_{LZOE} , and t_{HZC} is less than t_{LZC} at any given temperature and voltage.
- 5 t_{CH} is measured as high above V_{IH} , and t_{CL} is measured as low below V_{IL} .
- 6 This is a synchronous device. All addresses must meet the specified setup and hold times for all rising edges of CLK. All other synchronous inputs must meet the setup and hold times for all rising edges of CLK when chip is enabled.
- 7 Write refers to \overline{GWE} , \overline{BWE} , and $\overline{BW}[a,b]$.
- 8 Chip select refers to $\overline{CE0}$, CE1, and CE2.



Package dimensions

100-pin TQFP (quad flat pack)

	TQFP	
	Min	Max
A1	0.05	0.15
A2	1.35	1.45
b	0.22	0.38
c	0.09	0.20
D	13.90	14.10
E	19.90	20.10
e	0.65 nominal	
Hd	15.85	16.15
He	21.80	22.20
L	0.45	0.75
L1	1.00 nominal	
α	0°	7°
Dimensions in millimeters		

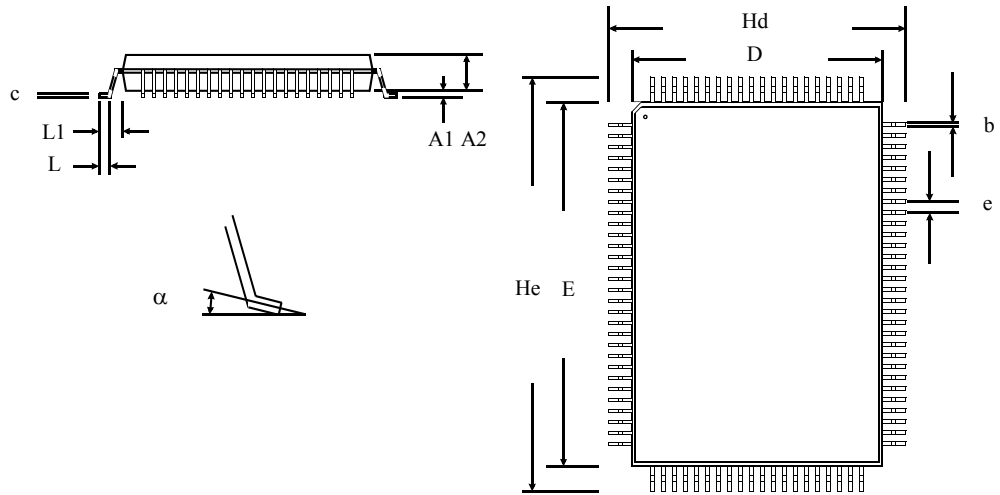

165-ball BGA (ball grid array)

All measurements are in mm.

	Min	Typ	Max
A		1.00	
B	14.90	15.00	15.10
C		14.00	
D	12.90	13.00	13.10
E		10.00	
F		0.26	
G	0.30	0.35	0.40
H			1.20
I	0.40	0.45	0.50

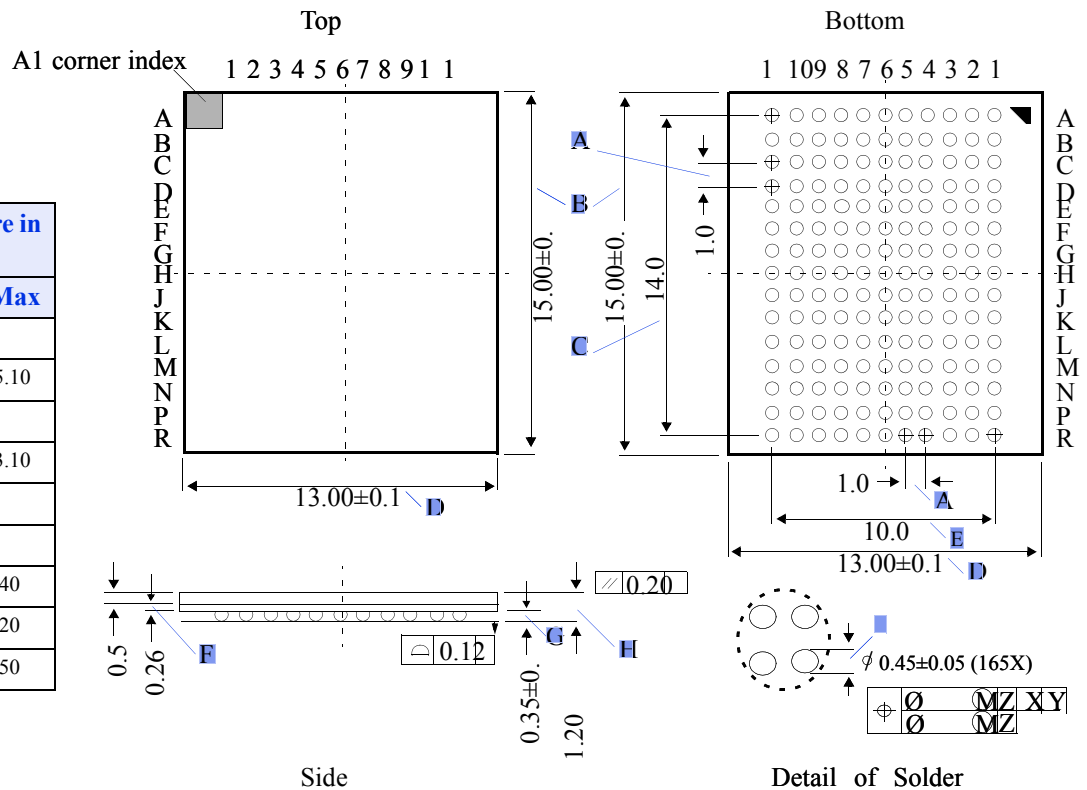



Ordering information

Package & Width	-85	-10
TQFP x18	AS7C331MFT18A-85TQC	AS7C331MFT18A-10TQC
	AS7C331MFT18A-85TQI	AS7C331MFT18A-10TQI
BGA x18	AS7C331MFT18A-85BC	AS7C331MFT18A-10BC
	AS7C331MFT18A-85BI	AS7C331MFT18A-10BI

Note: Add suffix 'N' to the above part numbers for Lead Free Parts (Ex. AS7C331MFT18A-85TQCN)

Part numbering guide

AS7C	33	1M	FT	18	A	-XX	TQ or B	C/I	X
1	2	3	4	5	6	7	8	9	10

- Alliance Semiconductor SRAM prefix
- Operating voltage: 33 = 3.3V
- Organization: 1M
- Flow-through mode
- Organization: 18 = x18
- Production version: A = first production version
- Clock speed
- Package type: TQ = TQFP; B = BGA
- Operating temperature: C = commercial (0° C to 70° C); I = industrial (-40° C to 85° C)
- N = Lead free part



Alliance Semiconductor Corporation
2575, Augustine Drive,
Santa Clara, CA 95054
Tel: 408 - 855 - 4900
Fax: 408 - 855 - 4999
www.alsc.com

Copyright © Alliance Semiconductor
All Rights Reserved
Part Number:AS7C331MFT18A
Document Version: v 1.0

© Copyright 2003 Alliance Semiconductor Corporation. All rights reserved. Our three-point logo, our name and Intelliwatt are trademarks or registered trademarks of Alliance. All other brand and product names may be the trademarks of their respective companies. Alliance reserves the right to make changes to this document and its products at any time without notice. Alliance assumes no responsibility for any errors that may appear in this document. The data contained herein represents Alliance's best data and/or estimates at the time of issuance. Alliance reserves the right to change or correct this data at any time, without notice. If the product described herein is under development, significant changes to these specifications are possible. The information in this product data sheet is intended to be general descriptive information for potential customers and users, and is not intended to operate as, or provide, any guarantee or warrantee to any user or customer. Alliance does not assume any responsibility or liability arising out of the application or use of any product described herein, and disclaims any express or implied warranties related to the sale and/or use of Alliance products including liability or warranties related to fitness for a particular purpose, merchantability, or infringement of any intellectual property rights, except as express agreed to in Alliance's Terms and Conditions of Sale (which are available from Alliance). All sales of Alliance products are made exclusively according to Alliance's Terms and Conditions of Sale. The purchase of products from Alliance does not convey a license under any patent rights, copyrights; mask works rights, trademarks, or any other intellectual property rights of Alliance or third parties. Alliance does not authorize its products for use as critical components in life-supporting systems where a malfunction or failure may reasonably be expected to result in significant injury to the user, and the inclusion of Alliance products in such life-supporting systems implies that the manufacturer assumes all risk of such use and agrees to indemnify Alliance against all claims arising from such use.