



Package: SOT-89



Product Description

RFMD's CXE-1089Z is a high performance 75Ω pHEMT MMIC low-noise amplifier utilizing a Darlington configuration with active bias. The active bias network provides stable current over temperature and process threshold voltage variations. The CXE-1089Z amplifier operates linearly from +3.3V_{DC}, +4.75V_{DC}, or +5V_{DC} power supplies.

Features

- Flat Gain: 13 dB +/- 0.4 dB, 50 MHz to 1000 MHz
- Excellent Return Loss: > 15.5 dB
- Low Distortion: CTB = -82 dBc, CSO = -66 dBc
- Operates from Single, Fixed +3.3V_{DC}, +4.75V_{DC}, or +5V_{DC} Supply
- On-Chip Active Bias Network

Applications

- CATV Set Top Box / Tuners
- CATV Drop Amplifiers
- Optical Rx/Tx
- FTTH Video Solutions

Optimum Technology Matching® Applied

- GaAs HBT
- GaAs MESFET
- InGaP HBT
- SiGe BiCMOS
- Si BiCMOS
- SiGe HBT
- GaAs pHEMT
- Si CMOS
- Si BJT
- GaN HEMT
- InP HBT
- RF MEMS
- LDMOS

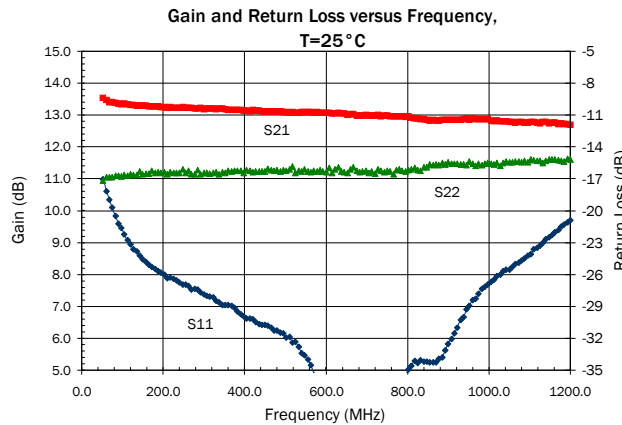

Parameter	Specification			Unit	Condition
	Min.	Typ.	Max.		
Small Signal Gain		13.0		dB	500MHz
Gain Flatness		+/-0.4		dB	50MHz to 1000MHz
Output Power at 1dB Compression		18.5		dBm	500MHz
Output Third Order Intercept Point		38.5		dBm	500MHz
CSO		-66.0		dBc	55.25 MHz to 745.25 MHz, 110Ch, Flat Tilt, 15 dBmV Input
CTB		-82.0		dBc	55.25 MHz to 745.25 MHz, 110Ch, Flat Tilt, 15 dBmV Input
XMOD		-78.0		dBc	55.25 MHz to 745.25 MHz, 110Ch, Flat Tilt, 15 dBmV Input
Input Return Loss, Worst Case		16.5		dB	50MHz to 1000MHz
Output Return Loss, Worst Case		15.5		dB	50MHz to 1000MHz
Noise Figure		3.0		dB	500MHz
Device Operating Voltage		5.00	5.25	V	
Device Operating Current		110.0		mA	Quiescent
Thermal Resistance		57.5		°C/W	Junction-to-case

Test Conditions: V_D = 5V, I_D = 110mA Typ, OIP₃ Tone Spacing = 1MHz, P_{OUT} per tone = 8dBm, T_L = 25°C, Z_S = Z_L = 75Ω, Tested with App Circuit

Parameter	Specification			Unit	Condition
	Min.	Typ.	Max.		
Small Signal Gain		12.9		dB	500MHz
Gain Flatness		+/-0.4		dB	50MHz to 1000MHz
Output Power at 1dB Compression		17.2		dBm	500MHz
Output Third Order Intercept Point		37.8		dBm	500MHz
CSO		-61		dBc	55.25 MHz to 547.25 MHz, 79Ch, NTSC, Flat Tilt, +15.5 dBmV Input
CTB		-79		dBc	55.25 MHz to 547.25 MHz, 79Ch, NTSC, Flat Tilt, +15.5 dBmV Input
Input Return Loss, Worst Case		16.4		dB	50 MHz to 1000 MHz, -40 °C to +85 °C
Output Return Loss, Worst Case		17.5		dB	50 MHz to 1000 MHz, -40 °C to +85 °C
Noise Figure		2.9		dB	500MHz
Device Operating Voltage		4.75	4.9	V _{DC}	
Device Operating Current		106		mA	Quiescent

Test Conditions: V_D=+4.75V_{DC}, I_D=106mA, Typ. OIP3 Tone Spacing=1MHz, P_{OUT} per tone=+8dBm
 T=+25 °C, Z_S=Z_L=75Ω, Tested with +5V_{DC} Applications Circuit

Parameter	Specification			Unit	Condition
	Min.	Typ.	Max.		
Small Signal Gain		12.7		dB	500MHz
Gain Flatness		+/-0.4		dB	50MHz to 1000MHz
Output Power at 1dB Compression		14.2		dBm	500MHz
Output Third Order Intercept Point		35.4		dBm	500MHz
CSO		-56		dBc	55.25 MHz to 547.25 MHz, 79Ch, NTSC, Flat Tilt, +15.5 dBmV Input
CTB		-78		dBc	55.25 MHz to 547.25 MHz, 79Ch, NTSC, Flat Tilt, +15.5 dBmV Input
Input Return Loss, Worst Case		16.4		dB	50 MHz to 1000 MHz, -40 °C to +85 °C
Output Return Loss, Worst Case		17.5		dB	50 MHz to 1000 MHz, -40 °C to +85 °C
Noise Figure		2.8		dB	500MHz
Device Operating Voltage		3.3	3.5	V _{DC}	
Device Operating Current		75		mA	Quiescent

Test Conditions: V_D=+3.3V_{DC}, I_D=75mA, Typ. OIP3 Tone Spacing=1MHz, P_{OUT} per tone=+8dBm
 T=+25 °C, Z_S=Z_L=75Ω, Tested with +5V_{DC} Applications Circuit

Absolute Maximum Ratings

Parameter	Rating	Unit
Device Current (I _D)	125	mA
Device Voltage (V _D)	5.5	V
Power Dissipation	690	mW
RF Input Power* (See Note)	23	dBm
Junction Temperature (T _J)	+150	°C
Operating Temperature Range (T _L)	-40 to +85	°C
Storage Temperature Range	-65 to +150	°C
ESD Rating - Human Body Model (HBM)	Class 1A	
Moisture Sensitivity Level	MSL 2	

*Note: Load condition, 10:1 VSWR

Operation of this device beyond any one of these limits may cause permanent damage. For reliable continuous operation, the device voltage and current must not exceed the maximum operating values specified in the table on page one.

Bias conditions should also satisfy the following expression:

$$I_D V_D < (T_J - T_{L}) / R_{TH, J-I}$$

$$T_L = T_{LEAD}$$



Caution! ESD sensitive device.

Exceeding any one or a combination of the Absolute Maximum Rating conditions may cause permanent damage to the device. Extended application of Absolute Maximum Rating conditions to the device may reduce device reliability. Specified typical performance or functional operation of the device under Absolute Maximum Rating conditions is not implied.

RoHS status based on EU Directive 2002/95/EC (at time of this document revision).

The information in this publication is believed to be accurate and reliable. However, no responsibility is assumed by RF Micro Devices, Inc. ("RFMD") for its use, nor for any infringement of patents, or other rights of third parties, resulting from its use. No license is granted by implication or otherwise under any patent or patent rights of RFMD. RFMD reserves the right to change component circuitry, recommended application circuitry and specifications at any time without prior notice.

Parameters	Units	Frequency (MHz)					
		50	250	550	750	850	1050
Small Signal Gain	dB	13.5	13.2	13.1	13.0	12.8	12.8
Output Power at 1dB Compression	dBm	16.6	17.2	18.6	18.9	19.1	19.5
Output Third Order Intercept Point	dBm	37.5	38.5	38.5	37.5	37.5	37.5
Output Second Order Intercept Point	dBm	63.5	64.5	62.5	60.5	55.5	54.5
Input Return Loss	dB	-17.5	-27.5	-33.5	-38.5	-34.5	-25.5
Reverse Isolation	dB	-17.5	-17.5	-17.5	-17.5	-17.5	-17.5
Output Return Loss	dB	-17.5	-16.5	-16.5	-16.5	-15.5	-15.5
Noise Figure	dB	3.5	2.5	2.5	2.5	2.5	2.5

Test Conditions: $V_D=5V$ $I_D=110mA$ Typ. OIP_3, OIP_2 Tone Spacing=1MHz, P_{OUT} per tone=8dBm
 $T_L=25^\circ C$ $Z_S=Z_L=75\Omega$ Tested with App Circuit

Current versus Voltage ($R_{BIAS}=Open$)

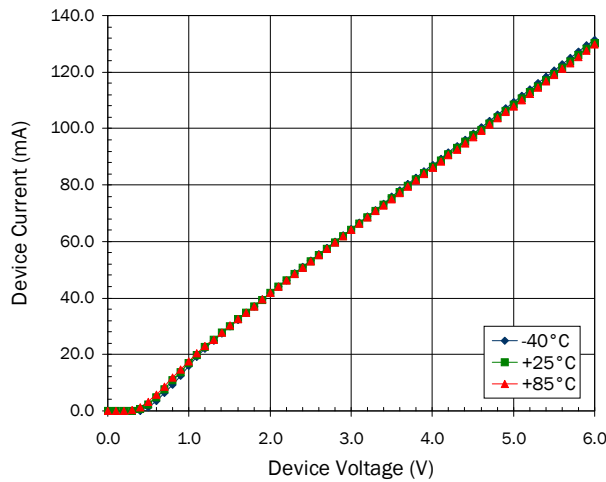

Application Circuit Performance ($V_D = 5V$, $I_D = 110mA$, $R_{BIAS} = \text{open}$)

S11 versus Frequency

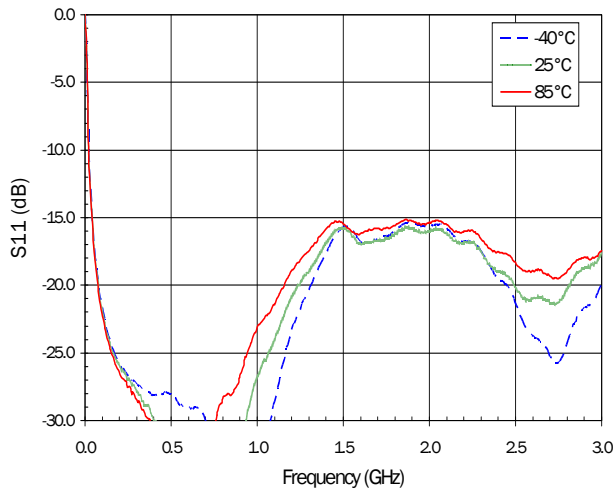

S21 versus Frequency

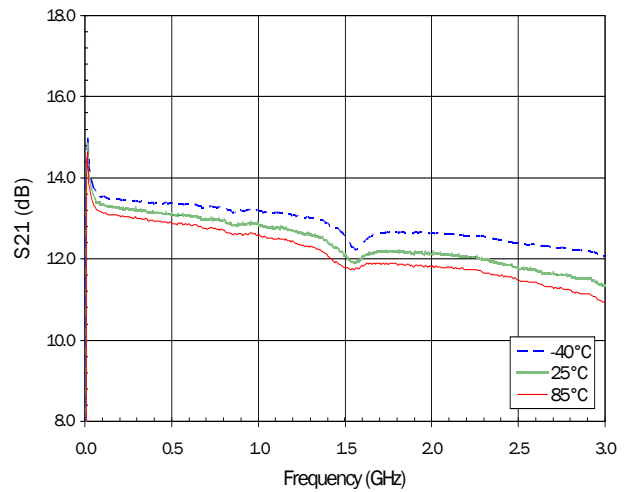

S12 versus Frequency

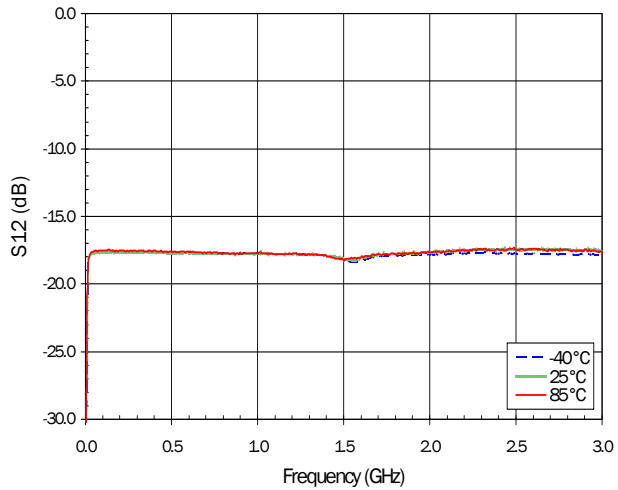

S22 versus Frequency

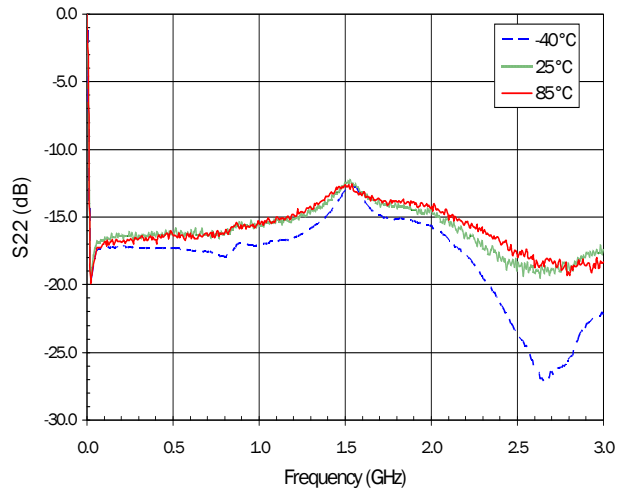

Application Circuit Performance ($V_D=5V$, $I_D=110mA$, $R_{BIAS}=open$)

NF versus Frequency

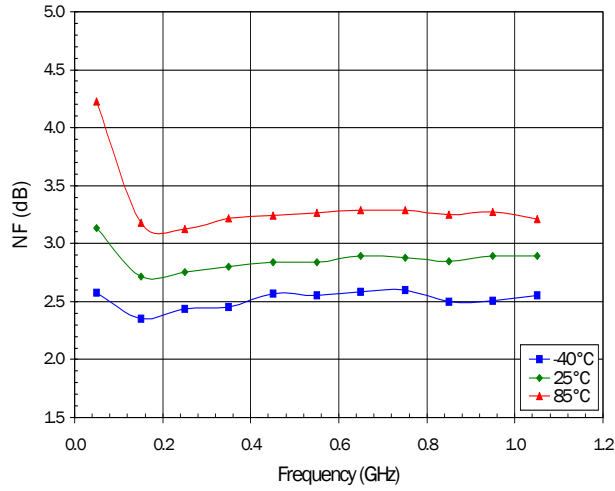

P_{1dB} versus Frequency

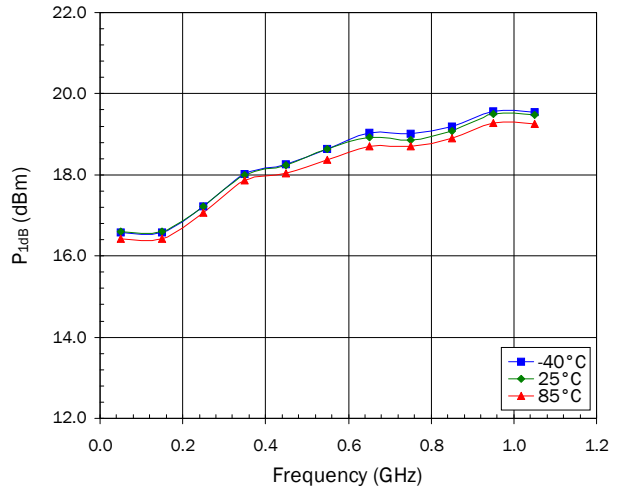

OIP_3 (8dBm/tone, 1MHz spacing)

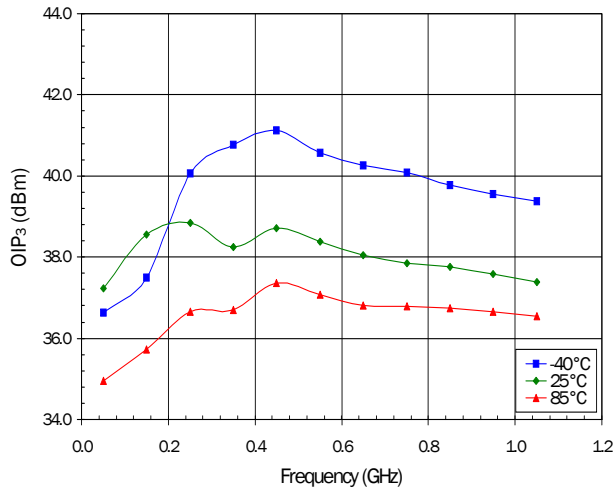

OIP_2 (8dBm/tone, 1MHz spacing)

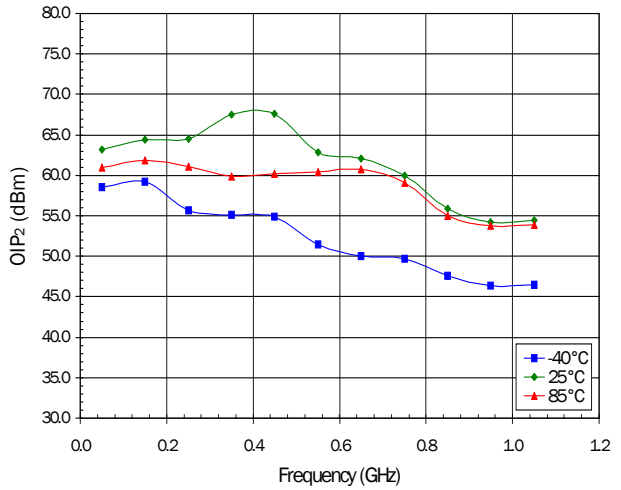

Composite Performance - Application Circuit: ($V_D=5V$, $I_D=110mA$, 110Ch. Flat Tilt, $R_{BIAS}=Open$)

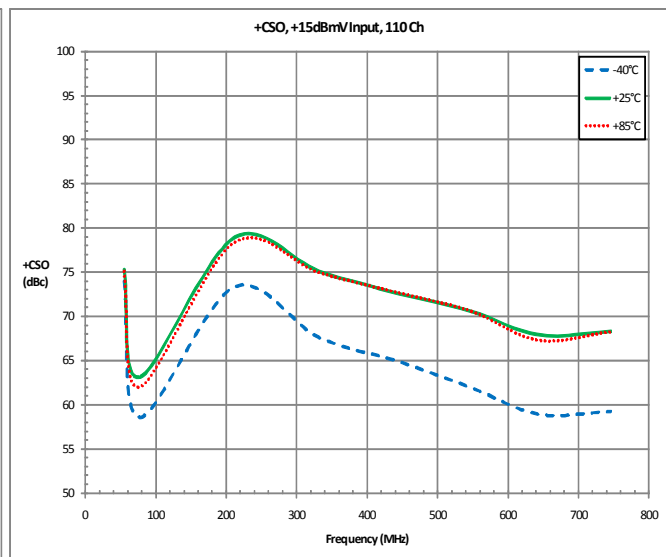
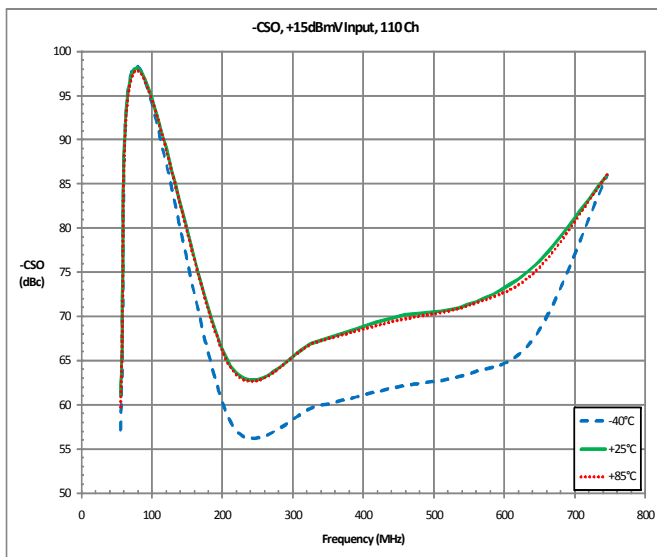
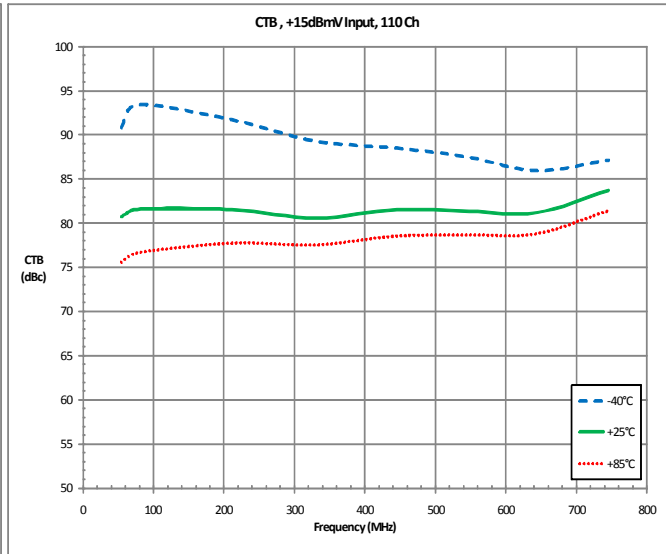
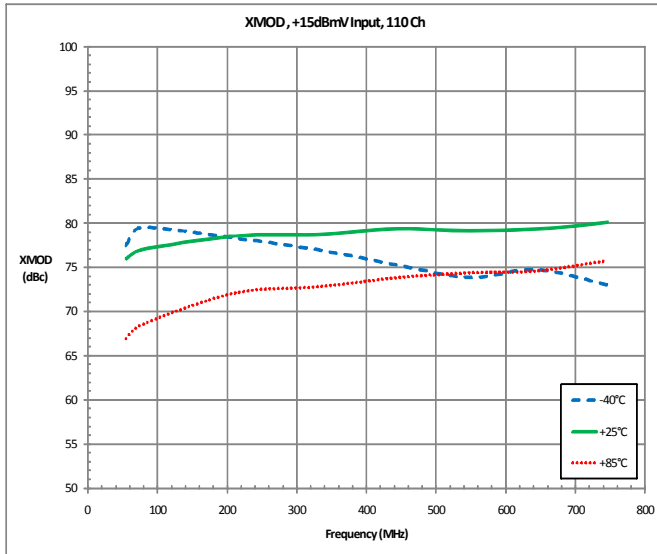

Application Circuit Performance versus Device Current (varying R_{BIAS}) $V_D=5.0V$, $T=+25^\circ C$

S11 versus Frequency

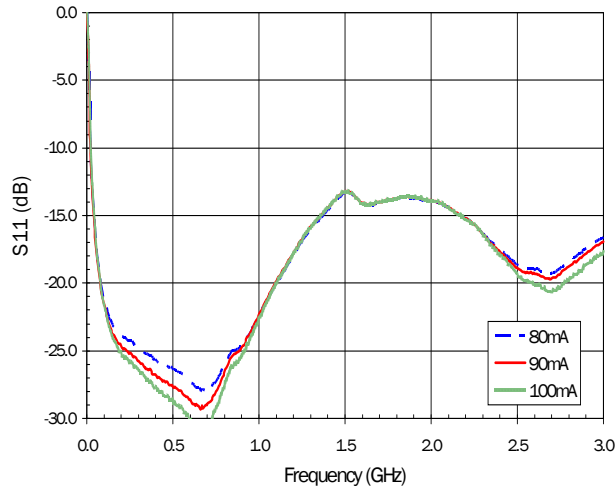

S21 versus Frequency

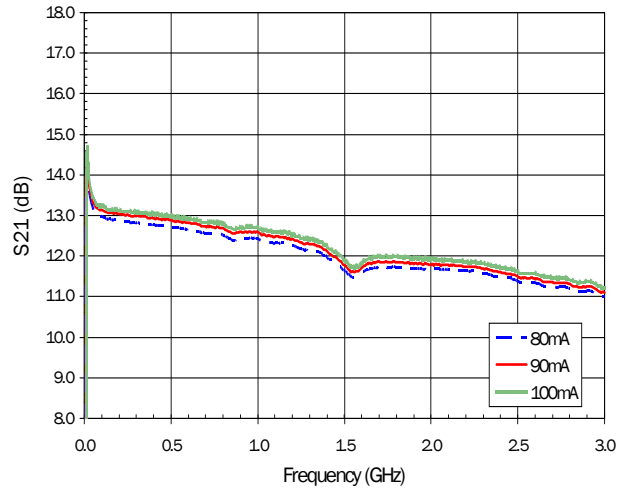

S12 versus Frequency

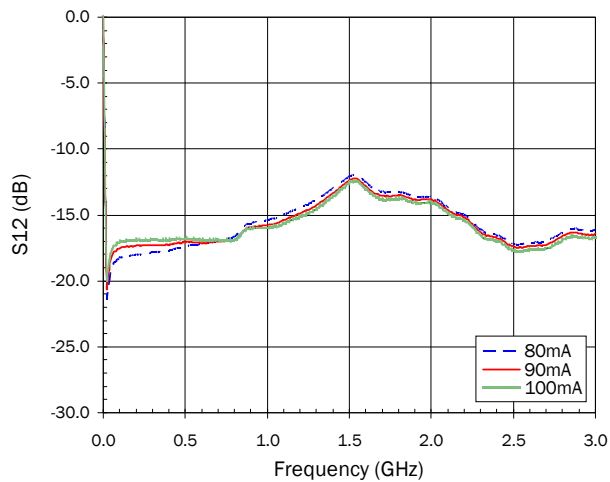

S22 versus Frequency

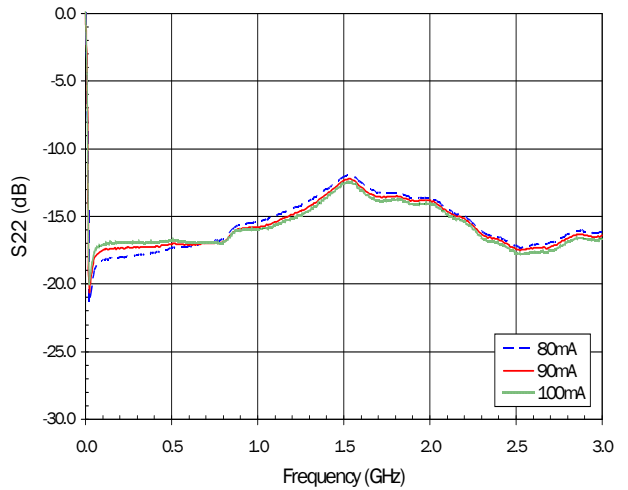

Application Circuit Performance versus Device Current (R_{BIAS}) $V_D=5.0V$, $T=+25^\circ C$

NF versus Frequency

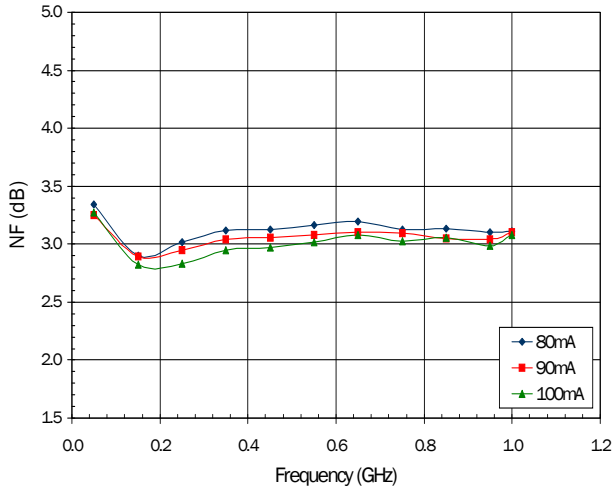

P_{1dB} versus Frequency

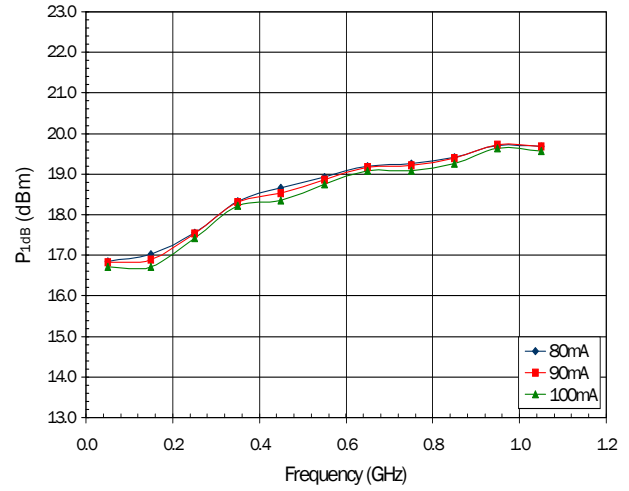

OIP_3 versus Frequency (8dBm/tone, 1MHz spacing)

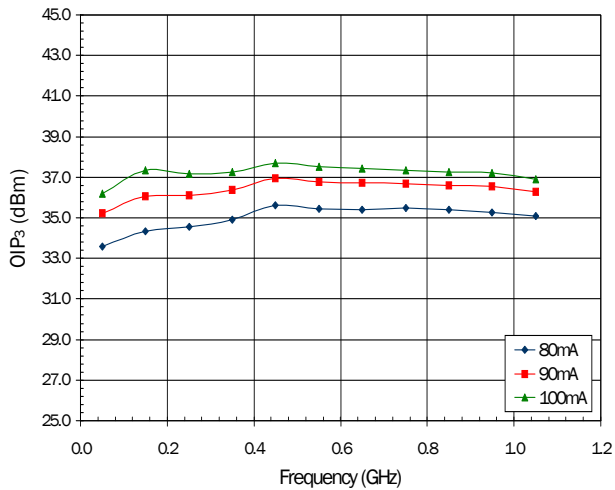

OIP_2 versus Frequency (8dBm/tone, 1MHz spacing)

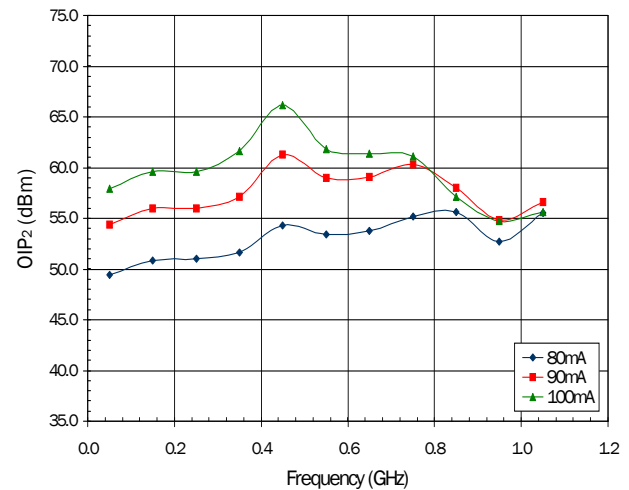

Application Circuit Performance versus Device Current (R_{BIAS}) $V_D=5.0V$, $T=+25^\circ C$

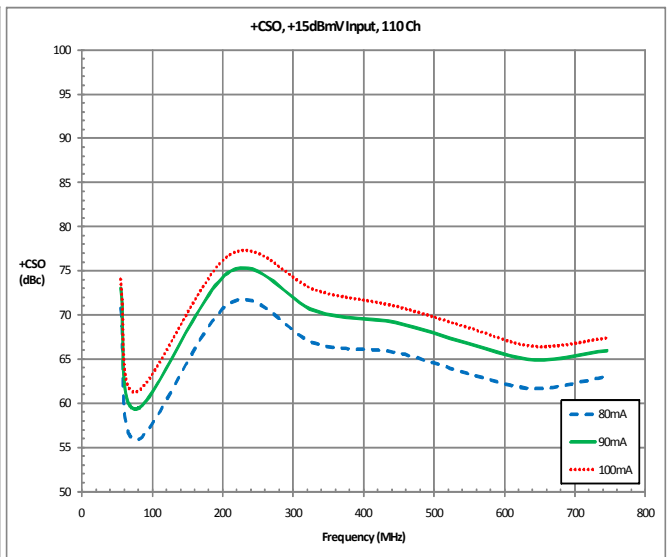
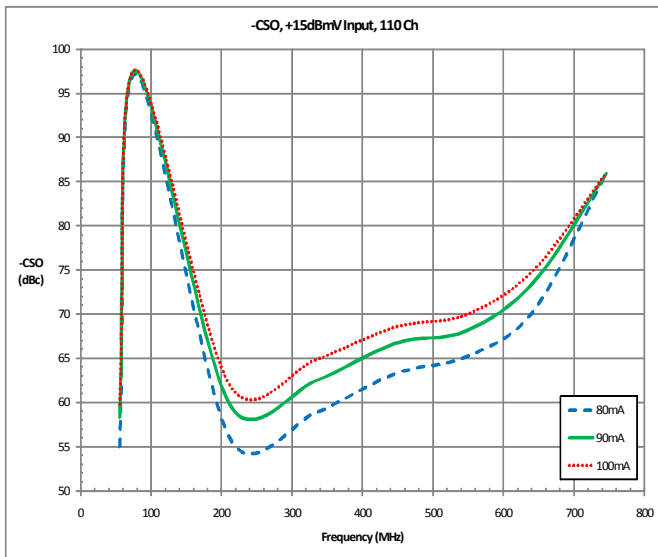
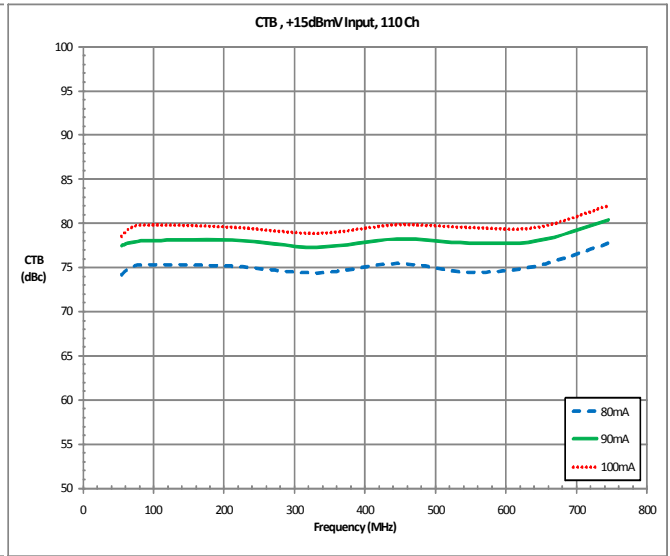
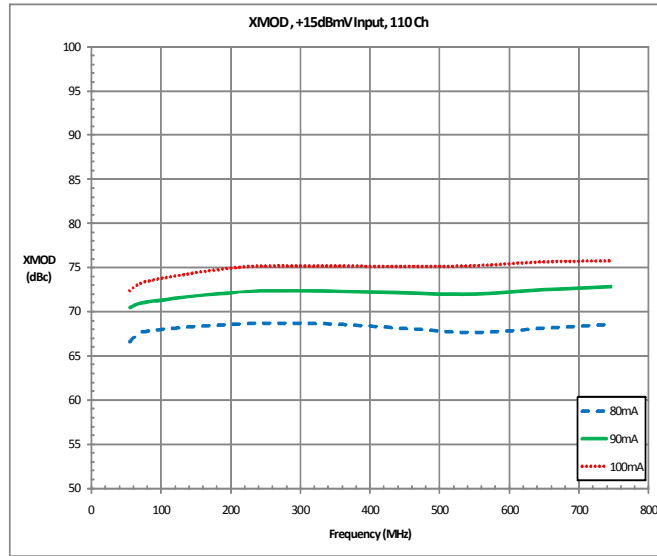

Application Schematic

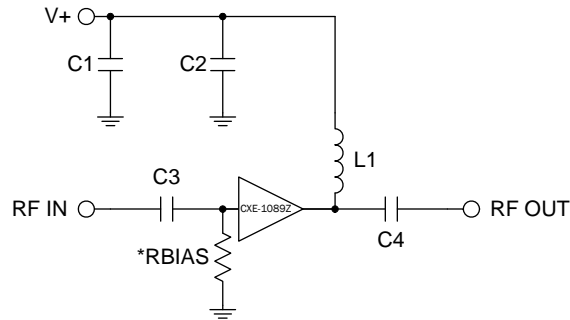

Application Circuit Element Values

Reference Designator	Frequency (MHz) 50 to 1200
F-connectors	
C1, C3, C4	1000pF 0603 size
C2	100pF 0603 size
L1	1.2uH 1008LS size
*R _{BIAS}	See table below

*Optional shunt resistor can be used to lower device current. Performance degradation may occur.

R _{BIAS}	Device Current (V _D = 5.0V)
1.3kΩ	80mA
2.4kΩ	90mA
4.7kΩ	100mA
open	110mA

Evaluation Board Layout and Bill of Materials

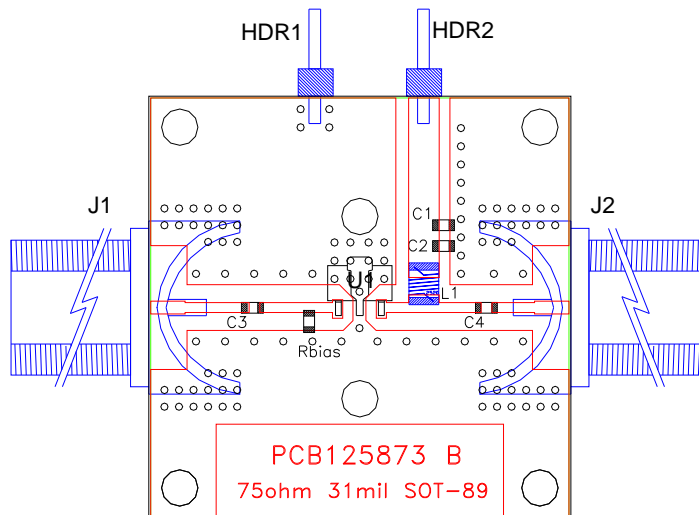

Mounting Instructions

1. Solder the copper pad on the backside of the device package to the ground plane.
2. Use a large ground pad area with many plated through-holes as shown.
3. We recommend 1 or 2 ounce copper. Measurements for this data sheet were made on a 31mil thick GTEK board with 1 ounce copper on both sides.

Pin	Function	Description
1	RFIN	RF input pin. This pin requires the use of an external DC blocking capacitor chosen for the frequency of operation.
2, 4	GND	Connection to ground. Use via holes as close as possible to the ground leads to minimize inductance.
3	RFOUT/BIAS	RF output and bias pin. DC voltage is present on this pin, therefore a DC blocking capacitor is necessary for proper operation.

Package Marking

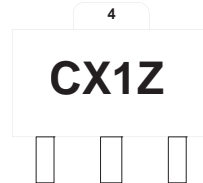

Alternate marking "CXE1089Z" on line one with Trace Code on line two.

Recommended Land Pattern Drawings

Dimensions shown in inches [mm]

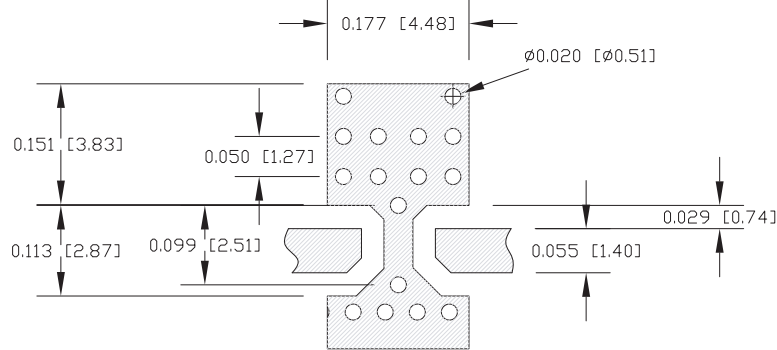

Package Drawing

Dimensions in inches (millimeters)

Refer to drawing posted at www.rfmd.com for tolerances.

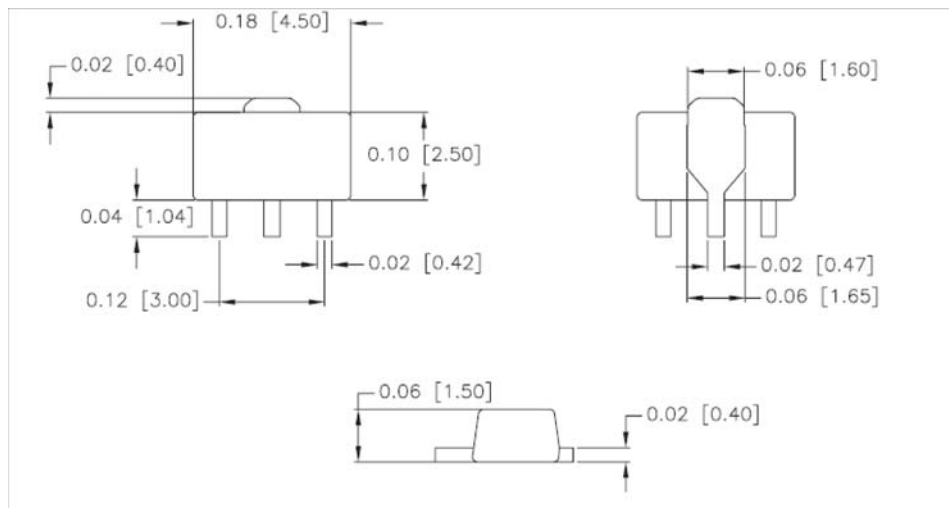

Ordering Information

Part Number	Description	Reel Size	Devices/Reel
CXE-1089ZSB	5 pcs Sample Bag	N/A	N/A
CXE-1089ZSQ	25 pcs Sample Bag	N/A	N/A
CXE-1089ZSR	50MHz to 1200MHz 75Ω pHEMT MMIC LNA	7"	100 pcs
CXE-1089Z	50MHz to 1200MHz 75Ω pHEMT MMIC LNA	7"	1000 pcs
CXE1089PCK-EVB1	75Ω Evaluation Board & 5 Loose Pieces	N/A	N/A