

Features

- Diffused Junction
- Low Forward Voltage Drop
- High Current Capability
- High Reliability
- High Surge Current Capability

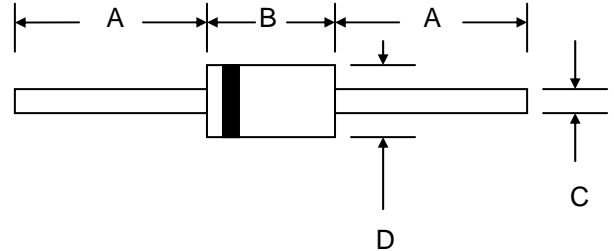

Mechanical Data

- Case: DO-15, Molded Plastic
- Terminals: Plated Leads Solderable per MIL-STD-202, Method 208
- Polarity: Cathode Band
- Weight: 0.40 grams (approx.)
- Mounting Position: Any
- Marking: Type Number
- **Lead Free: For RoHS / Lead Free Version, Add "-LF" Suffix to Part Number, See Page 4**

DO-15		
Dim	Min	Max
A	25.4	—
B	5.50	7.62
C	0.71	0.864
D	2.60	3.60
All Dimensions in mm		

Maximum Ratings and Electrical Characteristics @T_A=25°C unless otherwise specified

Single Phase, half wave, 60Hz, resistive or inductive load.
For capacitive load, derate current by 20%.

Characteristic	Symbol	FR151	FR152	FR153	FR154	FR155	FR156	FR157	Unit
Peak Repetitive Reverse Voltage	V _{RRM}	50	100	200	400	600	800	1000	V
Working Peak Reverse Voltage	V _{RWM}								
DC Blocking Voltage	V _R								
RMS Reverse Voltage	V _{R(RMS)}	35	70	140	280	420	560	700	V
Average Rectified Output Current (Note 1) @T _A = 55°C	I _O	1.5							A
Non-Repetitive Peak Forward Surge Current 8.3ms Single Half Sine-Wave Superimposed on Rated Load (JEDEC Method)	I _{FSM}	60							A
Forward Voltage @I _F = 1.5A	V _{FM}	1.2							V
Peak Reverse Current @T _A = 25°C At Rated DC Blocking Voltage @T _A = 100°C	I _{RM}	5.0 100							μA
Reverse Recovery Time (Note 2)	t _{rr}	150				250	500		nS
Typical Junction Capacitance (Note 3)	C _J	30							pF
Typical Thermal Resistance Junction to Ambient (Note 1)	R _{JA}	45							°C/W
Typical Thermal Resistance Junction to Lead (Note 1)	R _{JL}	20							
Operating Temperature Range	T _J	-65 to +125							°C
Storage Temperature Range	T _{STG}	-65 to +150							°C

- Note: 1. Leads maintained at ambient temperature at a distance of 9.5mm from the case.
2. Measured with I_F = 0.5A, I_R = 1.0A, I_{RR} = 0.25A.
3. Measured at 1.0 MHz and Applied Reverse Voltage of 4.0V D.C.

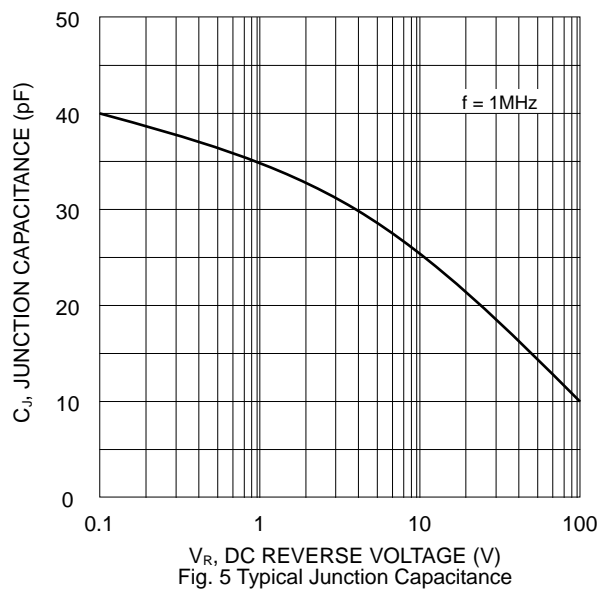
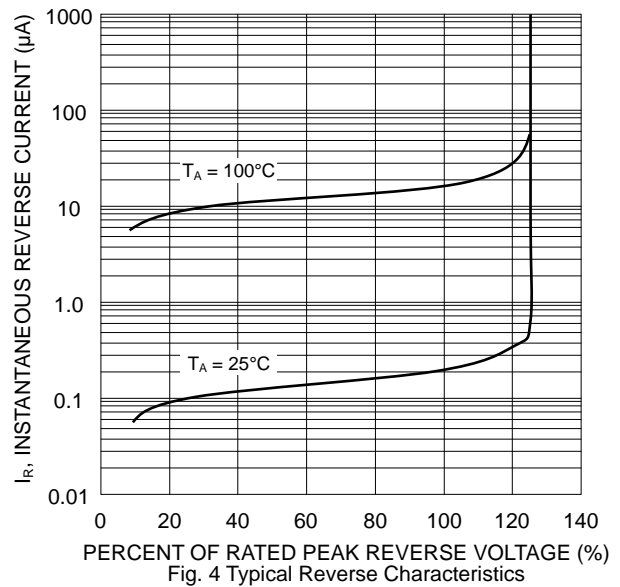
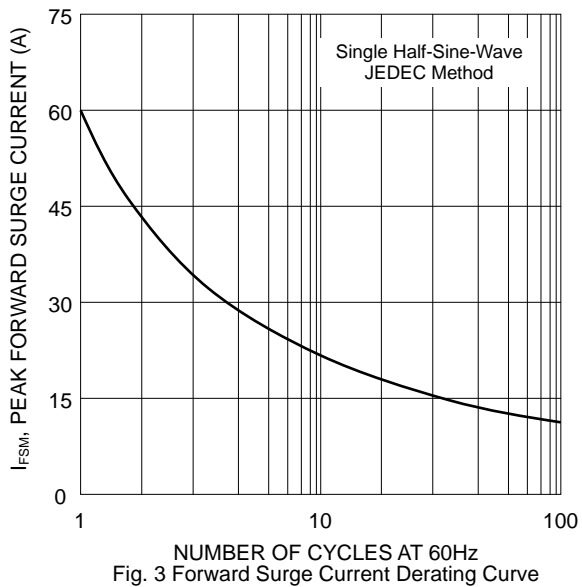
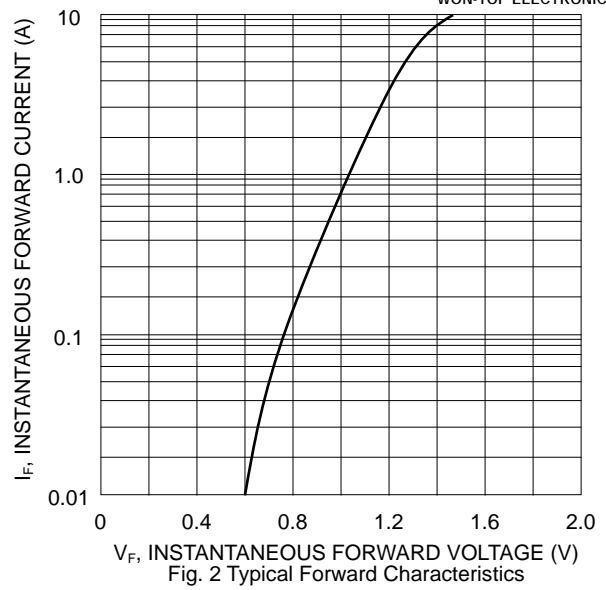
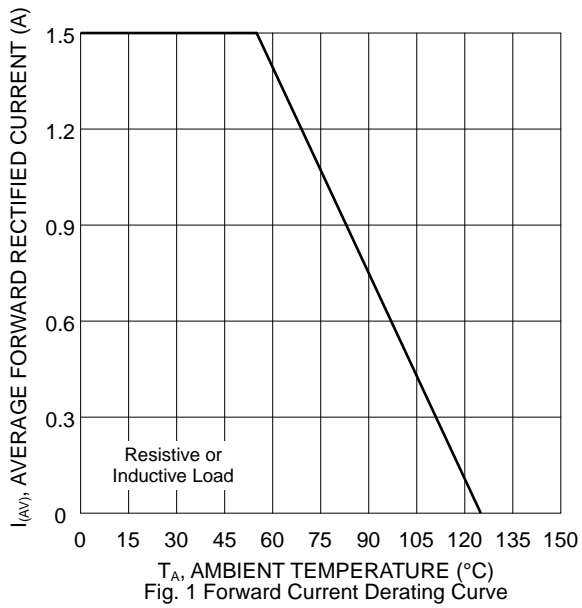

MARKING INFORMATION

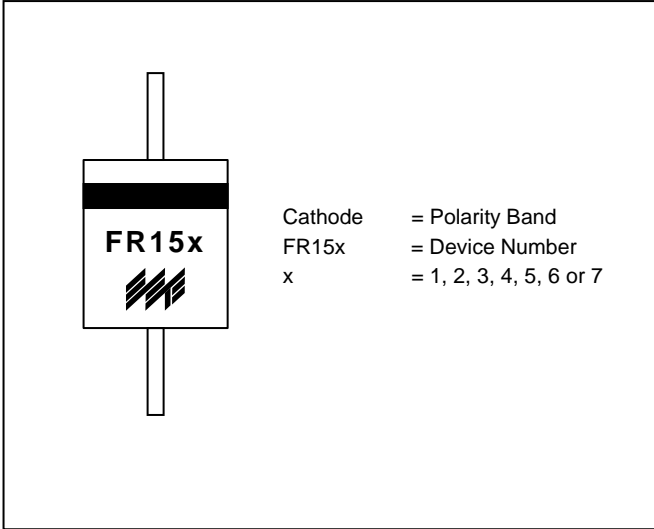

TAPING SPECIFICATIONS

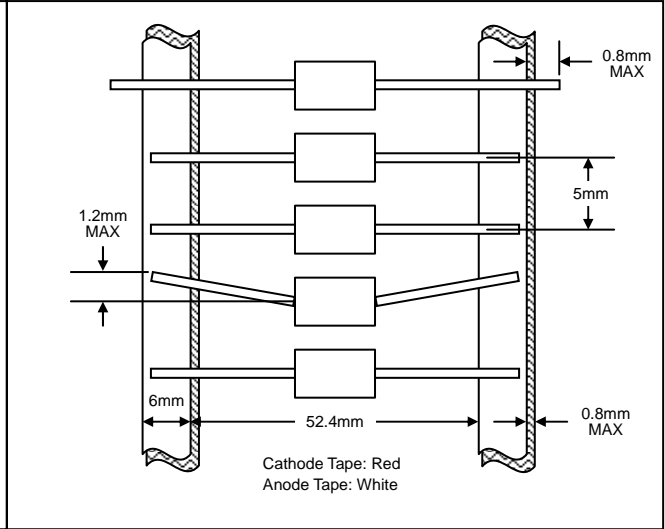

PACKAGING INFORMATION

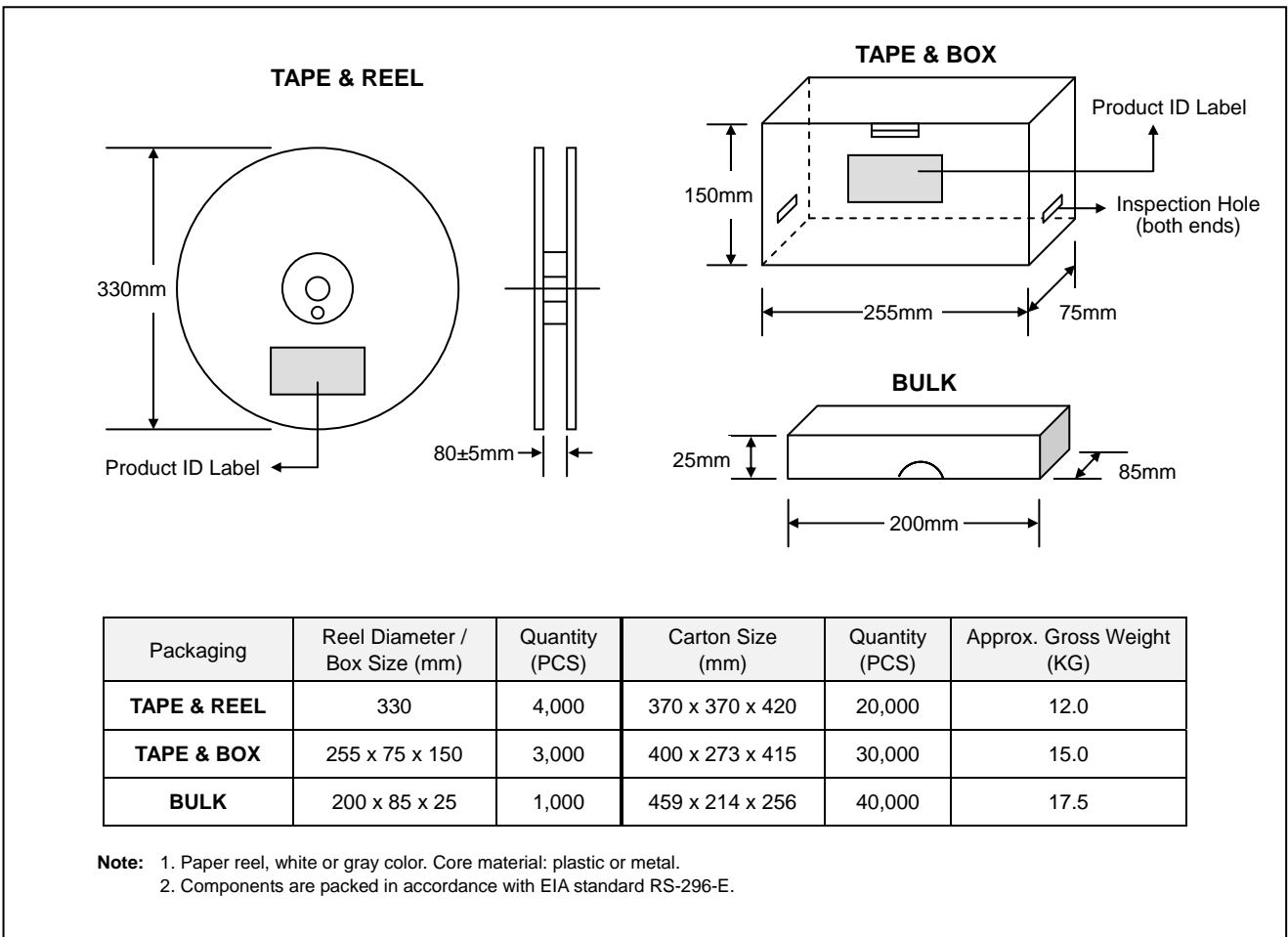

ORDERING INFORMATION

Product No.	Package Type	Shipping Quantity
FR15x-T3	DO-15	4000/Tape & Reel
FR15x-TB	DO-15	3000/Tape & Box
FR15x	DO-15	1000 Units/Box

1. Products listed in **bold** are WTE **Preferred** devices.
2. Shipping quantity given is for minimum packing quantity only. For minimum order quantity, please consult the Sales Department.
3. **To order RoHS / Lead Free version (with Lead Free finish), add "-LF" suffix to part number above. For example, FR151-TB-LF.**

WON-TOP ELECTRONICS and  are registered trademarks of Won-Top Electronics Co., Ltd (WTE). WTE has checked all information carefully and believes it to be correct and accurate. However, WTE cannot assume any responsibility for inaccuracies. Furthermore, this information does not give the purchaser of semiconductor devices any license under patent rights to manufacturer. WTE reserves the right to change any or all information herein without further notice.

WARNING: DO NOT USE IN LIFE SUPPORT EQUIPMENT. WTE power semiconductor products are not authorized for use as critical components in life support devices or systems without the express written approval.

Won-Top Electronics Co., Ltd.
No. 44 Yu Kang North 3rd Road,
Chine Chen Dist., Kaohsiung 806, Taiwan
Phone: 886-7-822-5408 or 886-7-822-5410
Fax: 886-7-822-5417
Email: sales@wontop.com
Internet: http://www.wontop.com

We power your everyday.