

Micropower No R_{SENSE} Constant Frequency Step-Down DC/DC Controller

FEATURES

- No Current Sense Resistor Required
- 40 μ A No-Load Quiescent Current
- High Output Currents Easily Achieved
- Internal Soft-Start Ramps V_{OUT}
- Wide V_{IN} Range: 2.75V to 9.8V
- Low Dropout: 100% Duty Cycle
- Constant Frequency 550kHz Operation
- Low Ripple Burst Mode[®] Operation at Light Load
- Output Voltage as Low as 0.8V
- $\pm 1.5\%$ Voltage Reference Accuracy
- Current Mode Operation for Excellent Line and Load Transient Response
- Only 8 μ A Supply Current in Shutdown
- Low Profile 8-Lead SOT-23 (1mm) and (3mm \times 2mm) DFN (0.75mm) Packages

APPLICATIONS

- 1- or 2-Cell Li-Ion Battery-Powered Applications
- Wireless Devices
- Portable Computers
- Distributed Power Systems

DESCRIPTION

The LTC[®]3772 is a constant frequency current mode step-down DC/DC controller in a low profile 8-lead SOT-23 (ThinSOT[™]) and a 3mm \times 2mm DFN package. The No R_{SENSE} [™] architecture eliminates the need for a current sense resistor, improving efficiency and saving board space.

The LTC3772 automatically switches into Burst Mode operation at light loads to increase efficiency at low output current. It consumes only 40 μ A of quiescent current under a no-load condition.

The LTC3772 incorporates an undervoltage lockout feature that shuts down the device when the input voltage falls below 2V. To maximize the runtime from a battery source, the external P-channel MOSFET is turned on continuously in dropout (100% duty cycle). High switching frequency of 550kHz allows the use of a small inductor and capacitors. An internal soft-start smoothly ramps the output voltage from zero to its regulation point.

LTC, LTC and LT are registered trademarks of Linear Technology Corporation. Burst Mode is a registered trademark of Linear Technology Corporation. ThinSOT and No R_{SENSE} are trademarks of Linear Technology Corporation. All other trademarks are the property of their respective owners.

TYPICAL APPLICATION

550kHz Micropower Step-Down DC/DC Converter

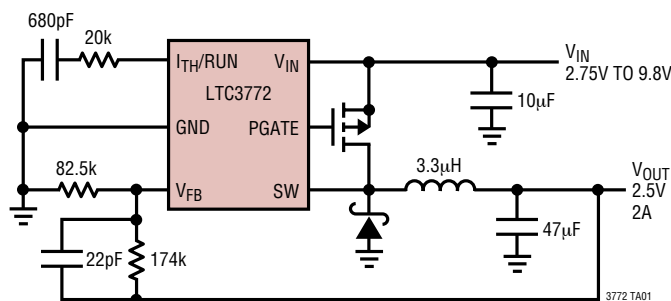

Efficiency and Power Loss vs Load Current

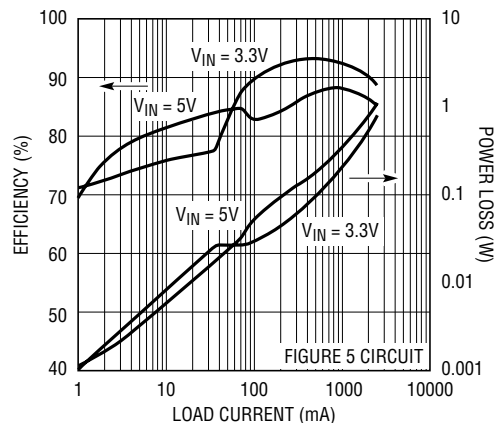

3772 TA01b

ABSOLUTE MAXIMUM RATINGS

(Note 1)

Input Supply Voltage (V_{IN}) -0.3V to 10V
 IPRG, PGATE Voltages -0.3V to ($V_{IN} + 0.3V$)
 V_{FB} , I_{TH}/RUN Voltages -0.3V to 2.4V
 SW Voltage -2V to ($V_{IN} + 1V$) or 10V Maximum
 PGATE Peak Output Current (<10 μ s) 1A

Operating Temperature Range (Note 2) .. -40°C to 85°C
 Junction Temperature (Note 3) 125°C
 Storage Temperature Range -65°C to 125°C
 Lead Temperature (Soldering, 10 sec)
 TSOT-23 300°C

PACKAGE/ORDER INFORMATION

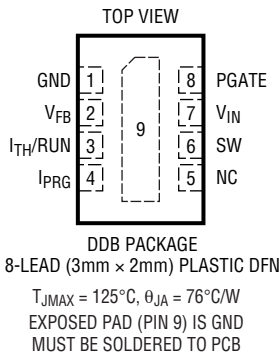
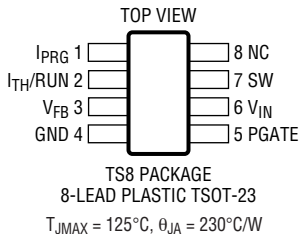
 <p>TOP VIEW</p> <p>GND 1, 2, 3, 4; PGATE 8; V_{IN} 7; SW 6; NC 5; V_{FB} 2; I_{TH}/RUN 3; IPRG 4; 9</p> <p>DDB PACKAGE 8-LEAD (3mm x 2mm) PLASTIC DFN</p> <p>$T_{JMAX} = 125^{\circ}C$, $\theta_{JA} = 76^{\circ}C/W$ EXPOSED PAD (PIN 9) IS GND MUST BE SOLDERED TO PCB</p>	ORDER PART NUMBER	 <p>TOP VIEW</p> <p>IPRG 1, 8 NC; I_{TH}/RUN 2, 7 SW; V_{FB} 3, 6 V_{IN}; GND 4, 5 PGATE</p> <p>TS8 PACKAGE 8-LEAD PLASTIC TSOT-23</p> <p>$T_{JMAX} = 125^{\circ}C$, $\theta_{JA} = 230^{\circ}C/W$</p>	ORDER PART NUMBER
	LTC3772EDDB		LTC3772ETS8
	DDB8 PART MARKING		TS8 PART MARKING
	LBNR		LTBNQ

Consult LTC Marketing for parts specified with wider operating temperature ranges.

ELECTRICAL CHARACTERISTICS

The ● indicates specifications which apply over the full operating temperature range, otherwise specifications are at $T_A = 25^{\circ}C$. $V_{IN} = 4.2V$ unless otherwise noted. (Note 2)

PARAMETER	CONDITIONS	MIN	TYP	MAX	UNITS
Input Voltage Range		● 2.75		9.8	V
Input DC Supply Current	(Note 4)				
Normal Operation	$V_{I_{TH}/RUN} = 1.3V$		250	375	μA
SLEEP Mode			40	60	μA
Shutdown	$V_{I_{TH}/RUN} = 0V$		8	20	μA
UVLO	$V_{IN} < UVLO$ Threshold - 100mV		1	5	μA
Undervoltage Lockout (UVLO) Threshold	V_{IN} Rising	● 2.0	2.0	2.75	V
	V_{IN} Falling	● 1.85	1.85	2.60	V
Start-Up Current Source	$V_{I_{TH}/RUN} = 0V$	0.7	1.2	1.7	μA
Shutdown Threshold (at I_{TH}/RUN)	$V_{I_{TH}/RUN}$ Rising	● 0.3	0.6	0.95	V
Regulated Feedback Voltage	$0^{\circ}C \leq T_A \leq 85^{\circ}C$ (Note 5)	● 0.788	0.800	0.812	V
	$-40^{\circ}C \leq T_A \leq 85^{\circ}C$ (Note 5)	● 0.780	0.800	0.812	V
Feedback Voltage Line Regulation	$2.75V \leq V_{IN} \leq 9.8V$ (Note 5)		0.08	0.2	mV/V
Feedback Voltage Load Regulation	$I_{TH}/RUN = 1.6V$ (Note 5)		0.2		%
	$I_{TH}/RUN = 1V$ (Note 5)		-0.2		%

ELECTRICAL CHARACTERISTICS

The ● indicates specifications which apply over the full operating temperature range, otherwise specifications are at $T_A = 25^\circ\text{C}$. $V_{IN} = 4.2\text{V}$ unless otherwise noted. (Note 2)

PARAMETER	CONDITIONS	MIN	TYP	MAX	UNITS
V_{FB} Input Current	(Note 5)	-10	2	10	nA
Overshoot Protect Threshold	Measured at V_{FB}	0.850	0.880	0.910	V
Overshoot Protect Hysteresis			40		mV
Oscillator Frequency					
Normal Operation	$V_{FB} = 0.8\text{V}$	500	550	650	kHz
Output Short Circuit	$V_{FB} = 0\text{V}$		200		kHz
Gate Drive Rise Time	$C_{LOAD} = 3000\text{pF}$		40		ns
Gate Drive Fall Time	$C_{LOAD} = 3000\text{pF}$		40		ns
Peak Current Sense Voltage	$I_{PRG} = \text{GND}$ (Note 6)	● 90	105	120	mV
	$I_{PRG} = \text{Floating}$	● 160	175	190	mV
	$I_{PRG} = V_{IN}$	● 228	245	262	mV
Default Soft-Start Time			0.6		ms

Note 1: Absolute Maximum Ratings are those values beyond which the life of a device may be impaired.

Note 2: The LTC3772ETS8/LTC3772EDDB are guaranteed to meet specifications from 0°C to 70°C . Specifications over the -40°C to 85°C operating temperature range are assured by design, characterization and correlation with statistical process controls.

Note 3: T_J is calculated from the ambient temperature T_A and power dissipation P_D according to the following formula:

$$T_J = T_A + (P_D \cdot \theta_{JA} \text{ } ^\circ\text{C/W})$$

Note 4: Dynamic supply current is higher due to the gate charge being delivered at the switching frequency.

Note 5: The LTC3772 are tested in a feedback loop that servos V_{FB} to the output of the error amplifier while maintaining I_{TH}/RUN at the midpoint of the current limit range.

Note 6: Peak current sense voltage is reduced dependent on duty cycle as given in Figure 1.

TYPICAL PERFORMANCE CHARACTERISTICS

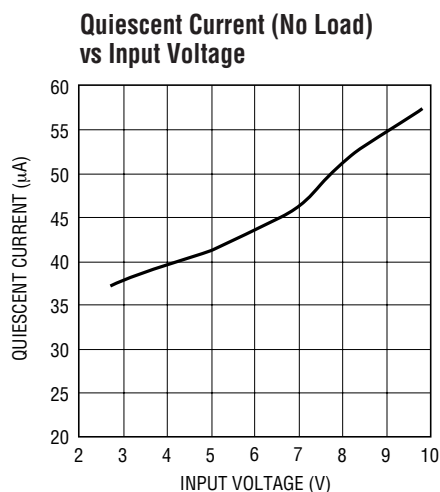

3772 G01

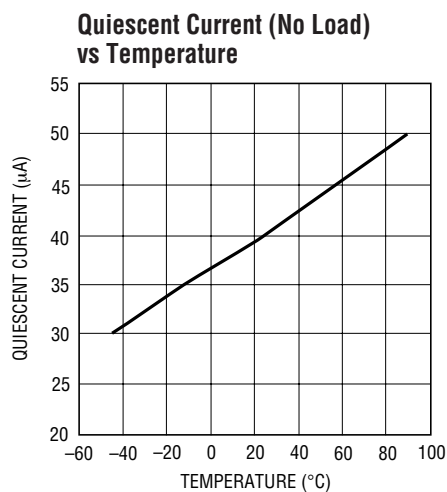

3772 G02

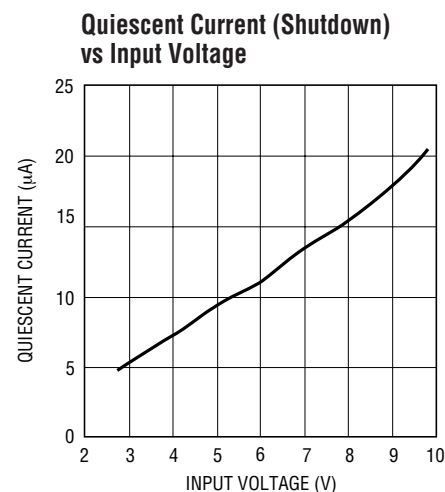

3772 G03

TYPICAL PERFORMANCE CHARACTERISTICS

Quiescent Current (Shutdown) vs Temperature

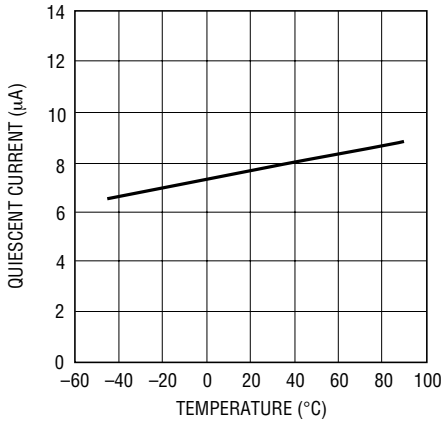

3772 G04

Shutdown Threshold vs Temperature

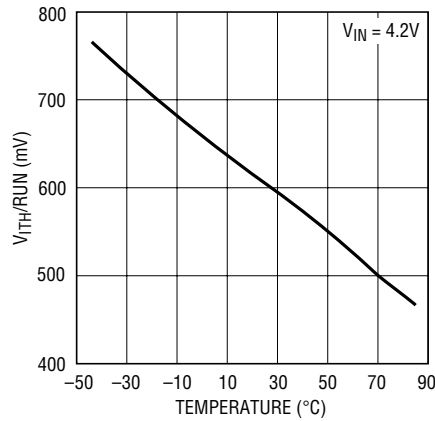

3772 G05

Regulated Feedback Voltage vs Temperature

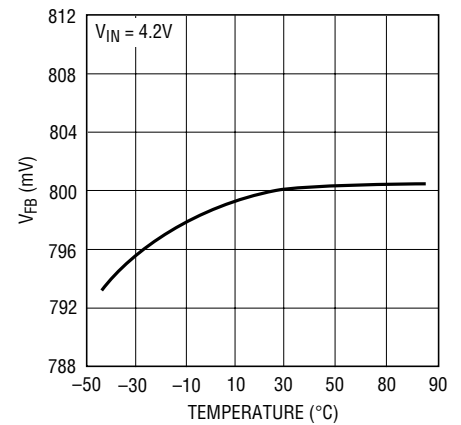

3772 G06

Regulated Feedback Voltage vs Input Voltage

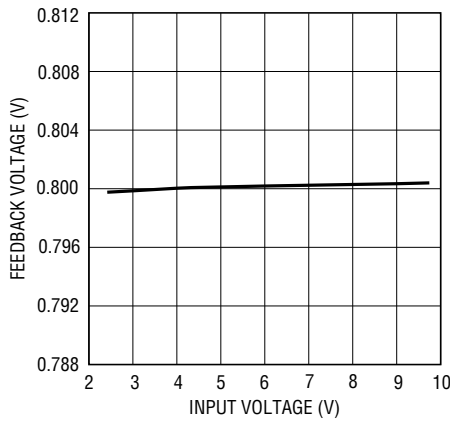

3772 G07

Oscillator Frequency vs Temperature

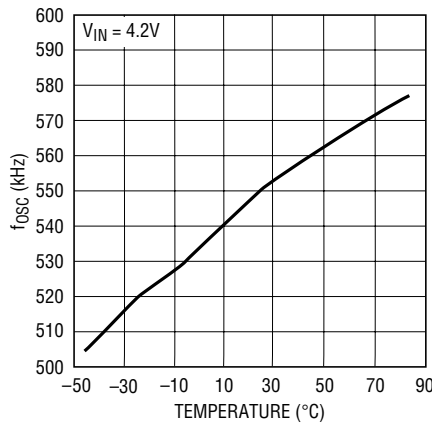

3772 G08

Oscillator Frequency vs Input Voltage

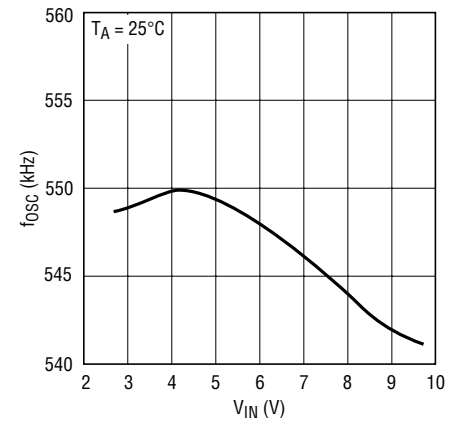

3772 G09

I_{TH}/RUN Start-Up Current vs Temperature

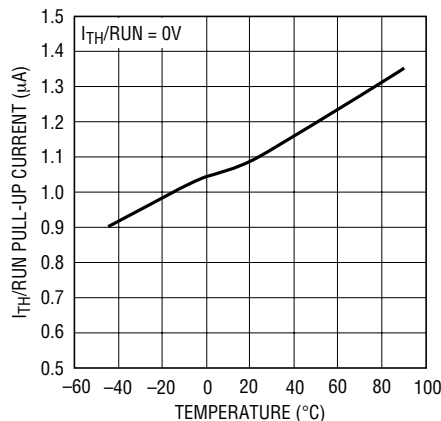

3772 FG10

I_{TH}/RUN Start-Up Current vs Input Voltage

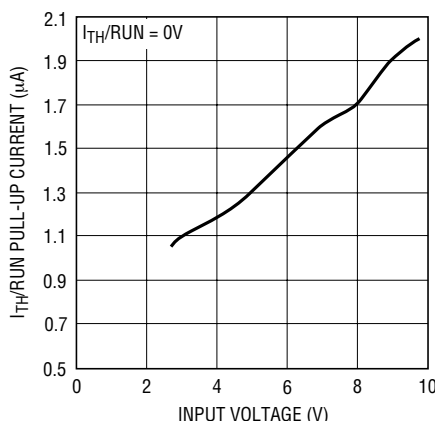

3772 G11

Undervoltage Lockout Thresholds vs Temperature

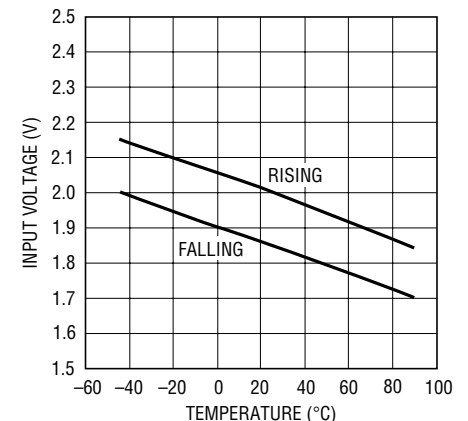

3772 G12

TYPICAL PERFORMANCE CHARACTERISTICS

Maximum Current Sense Threshold vs Temperature

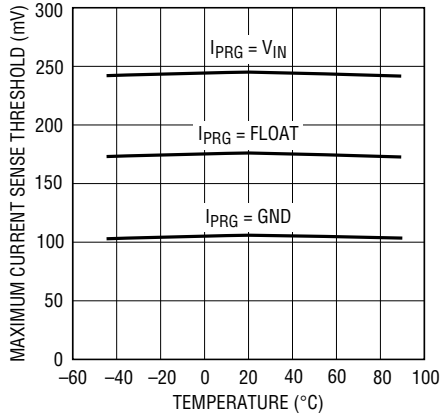

3772 G13

Soft-Start Time vs Temperature

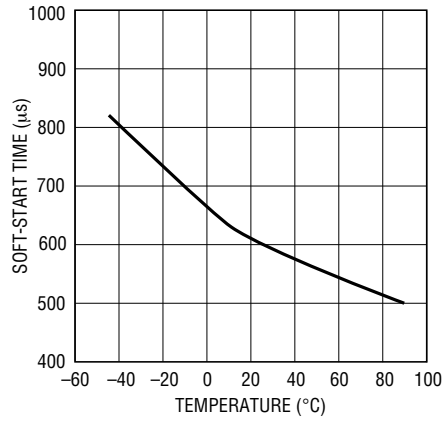

3772 G14

Foldback Frequency vs Temperature

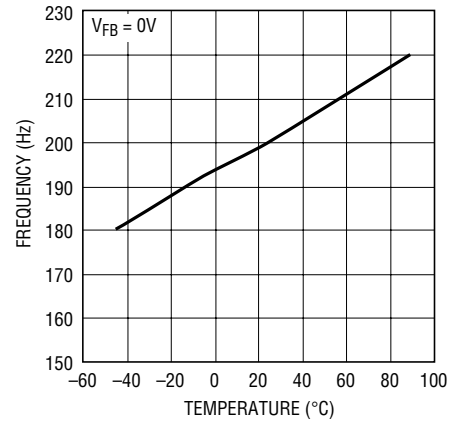

3772 G15

Efficiency vs Load Current

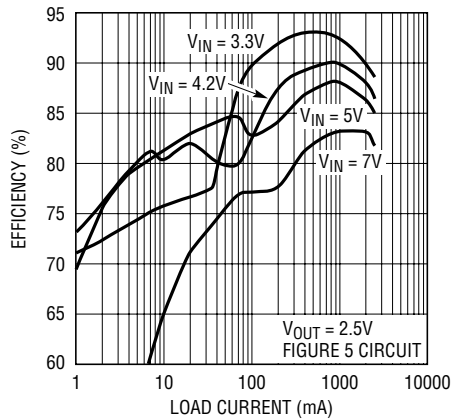

3772 G16

Efficiency vs Load Current

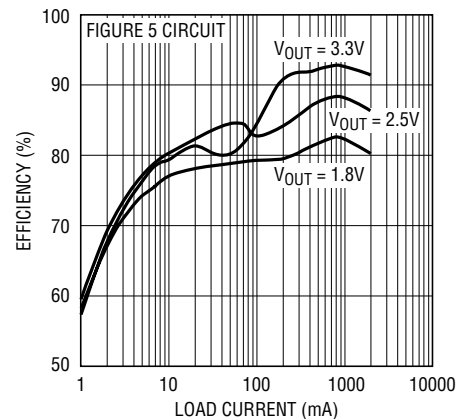

3772 G17

Start-Up

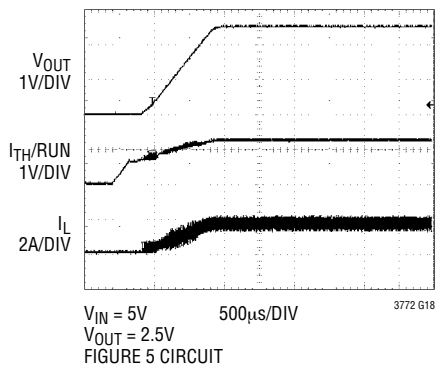

Load Step

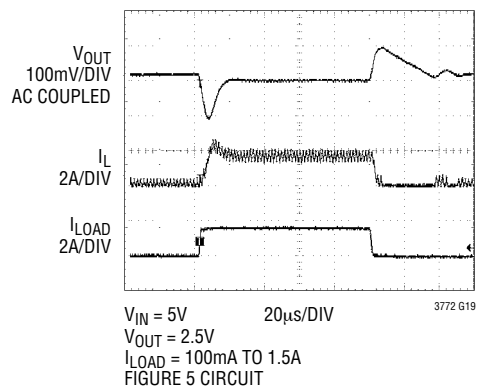

PIN FUNCTIONS (DDB/TS8)

GND (Pin 1/Pin 4): Ground Pin.

V_{FB} (Pin 2/Pin 3): Receives the feedback voltage from an external resistor divider across the output.

I_{TH}/RUN (Pin 3/Pin 2): This pin performs two functions. It serves as the error amplifier compensation point as well as the run control input. Nominal voltage range for this pin is 0.7V to 1.9V. Forcing this pin below 0.6V causes the device to be shut down. In shutdown, all functions are disabled and the PGATE pin is held high.

I_{PRG} (Pin 4/Pin 1): Current Sense Limit Pin. Three-state pin selects maximum peak sense voltage threshold. The pin selects the maximum voltage drop across the external P-channel MOSFET. Tie to V_{IN}, GND or float to select 245mV, 105mV or 175mV respectively.

NC (Pin 5/Pin 8): No Connection Required.

SW (Pin 6/Pin 7): Switch Node Connection to Inductor and Current Sense Input Pin. Normally, the external P-channel MOSFET's drain is connected to this pin.

V_{IN} (Pin 7/Pin 6): Supply and Current Sense Input Pin. This pin must be closely decoupled to GND (Pin 4). Normally the external P-channel MOSFET's source is connected to this pin.

PGATE (Pin 8/Pin 5): Gate Drive for the External P-Channel MOSFET. This pin swings from 0V to V_{IN}.

Exposed Pad (Pin 9, DDB Only): The Exposed Pad is ground and must be soldered to the PCB for electrical connection and optimum thermal performance.

FUNCTIONAL DIAGRAM

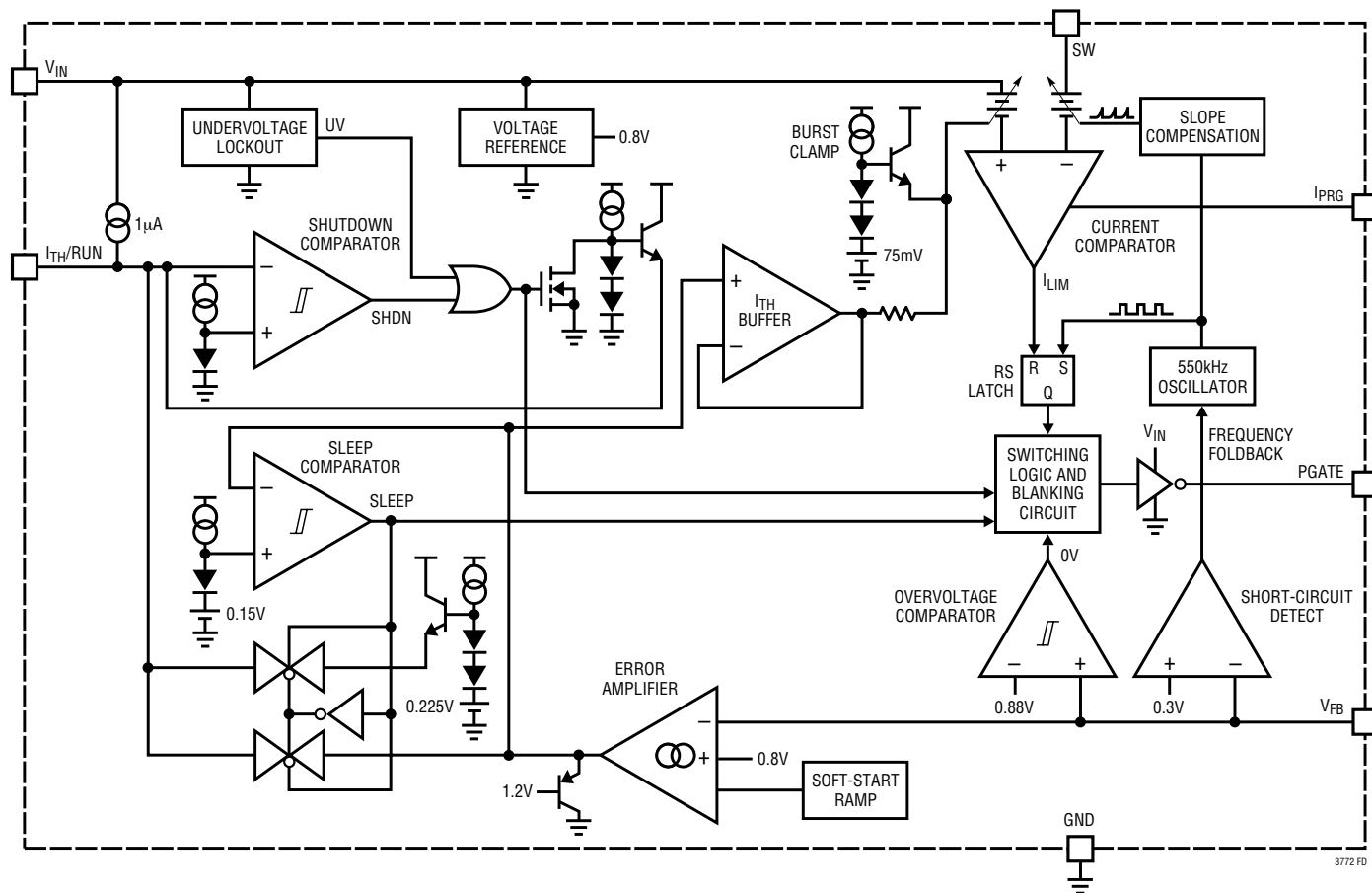

3772 FD

OPERATION (Refer to the Functional Diagram)

Main Control Loop (Normal Operation)

The LTC3772 is a constant frequency current mode step-down switching regulator controller. During normal operation, the external P-channel MOSFET is turned on each cycle when the oscillator sets the RS latch and turned off when the current comparator resets the latch. The peak inductor current at which the current comparator trips is controlled by the voltage on the I_{TH}/RUN pin, which is the output of the error amplifier. The negative input to the error amplifier is the output feedback voltage V_{FB} , which is generated by an external resistor divider connected between V_{OUT} and ground. When the load current increases, it causes a slight decrease in V_{FB} relative to the 0.8V reference, which in turn causes the I_{TH}/RUN voltage to increase until the average inductor current matches the new load current.

The main control loop is shut down by pulling the I_{TH}/RUN pin to ground. Releasing the I_{TH}/RUN pin allows an internal $1\mu A$ current source to charge up the external compensation network. When the I_{TH}/RUN pin voltage reaches approximately 0.6V, the main control loop is enabled and the I_{TH}/RUN voltage is pulled up by a clamp to its zero current level of approximately one diode voltage drop (0.7V). As the external compensation network continues to charge up, the corresponding peak inductor current level follows, allowing normal operation. The maximum peak inductor current attainable is set by a clamp on the I_{TH}/RUN pin at 1.2V above the zero current level (approximately 1.9V).

Burst Mode Operation

The LTC3772 incorporates Burst Mode operation at low load currents ($<10\%$ of I_{MAX}). In this mode, an internal clamp sets the peak current of the inductor at a level corresponding to an I_{TH}/RUN voltage 0.925V, even though the actual I_{TH}/RUN voltage is lower. When the inductor's average current is greater than the load requirement, the voltage at the I_{TH}/RUN pin will drop. When the I_{TH}/RUN voltage falls to 0.85V, the sleep comparator will trip, turning off the external MOSFET. In sleep, the input DC supply current to the IC is reduced to $40\mu A$ from $250\mu A$ in normal

operation. With the switch held off, average inductor current will decay to zero and the load will eventually cause the error amplifier output to start drifting higher. When the error amplifier output rises to 0.87V, the sleep comparator will untrip and normal operation will resume. The next oscillator cycle will turn the external MOSFET on and the switching cycle will repeat.

Dropout Operation

When the input supply voltage decreases towards the output voltage, the rate of change of inductor current during the on cycle decreases. This reduction means that at some input-output differential, the external P-channel MOSFET will remain on for more than one oscillator cycle (start dropping off-cycles) since the inductor current has not ramped up to the threshold set by the error amplifier. Further reduction in input supply voltage will eventually cause the external P-channel MOSFET to be turned on 100%; i.e., DC. The output voltage will then be determined by the input voltage minus the voltage drop across the sense resistor, the MOSFET and the inductor.

Undervoltage Lockout Protection

To prevent operation of the external P-channel MOSFET with insufficient gate drive, an undervoltage lockout circuit is incorporated into the LTC3772. When the input supply voltage drops below approximately 2V, the P-channel MOSFET and all internal circuitry other than the undervoltage block itself are turned off. Input supply current in undervoltage is approximately $1\mu A$.

Short-Circuit Protection

If the output is shorted to ground, the frequency of the oscillator is folded back from 550kHz to approximately 200kHz while maintaining the same minimum on time. This lower frequency allows the inductor current to safely discharge, thereby preventing current runaway. After the short is removed, the oscillator frequency will gradually increase back to 550kHz as V_{FB} rises through 0.3V on its way back to 0.8V.

OPERATION (Refer to the Functional Diagram)

Overvoltage Protection

If V_{FB} exceeds its regulation point of 0.8V by more than 10% for any reason, such as an output short-circuit to a higher voltage, the overvoltage comparator will hold the external P-channel MOSFET off. This comparator has a typical hysteresis of 40mV.

Peak Current Sense Voltage Selection and Slope Compensation (I_{PRG} Pins)

When a controller is operating below 20% duty cycle, the peak current sense voltage (between the SENSE⁺ and SW pins) allowed across the external P-channel MOSFET is determined by:

$$\Delta V_{SENSE(MAX)} = \frac{A(V_{ITH} - 0.7V)}{10} - 0.015$$

where A is a constant determined by the state of the I_{PRG} pins. Floating the I_{PRG} pin selects $A = 1.58$; tying I_{PRG} to V_{IN} selects $A = 2.2$; tying I_{PRG} to SGND selects $A = 0.97$. The maximum value of V_{ITH} is typically about 1.98V, so the maximum sense voltage allowed across the external P-channel MOSFET is 175mV, 100mV or 250mV for the three respective states of the I_{PRG} pin.

However, once the controller's duty cycle exceeds 20%, slope compensation begins and effectively reduces the peak sense voltage by a scale factor given by the curve in Figure 1.

The peak inductor current is determined by the peak sense voltage and the on-resistance of the external P-channel MOSFET:

$$I_{PEAK} = \frac{\Delta V_{SENSE(MAX)}}{R_{DS(ON)}}$$

Soft-Start

The start-up of V_{OUT} is controlled by the LTC3772 internal soft-start. During soft-start, the error amplifier EAMP compares the feedback signal V_{FB} to the internal soft-start ramp (instead of the 0.8V reference), which rises linearly from 0V to 0.8V in about 0.6ms. This allows the output voltage to rise smoothly from 0V to its final value, while maintaining control of the inductor current. After the soft-start is timed out, it is disabled until the part is put in shutdown again or the input supply is cycled.

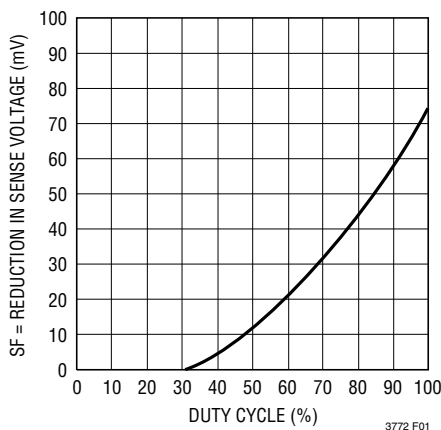

Figure 1. Reduction in Sense Voltage Due to Slope Compensation vs Duty Cycle

APPLICATIONS INFORMATION

The basic LTC3772 application circuit is shown on the front page of this data sheet. External component selection is driven by the load requirement and begins with the selection of the power MOSFET inductor and the output diode. These are selected followed by the input bypass capacitor C_{IN} and output bypass capacitor C_{OUT} .

Power MOSFET Selection

An external P-channel power MOSFET must be selected for use with the LTC3772. The main selection criteria for the power MOSFET are the threshold voltage $V_{GS(TH)}$ and the “on” resistance $R_{DS(ON)}$, reverse transfer capacitance C_{RSS} and total gate charge.

Since the LTC3772 is designed for operation down to low input voltages, a sublogic level threshold MOSFET ($R_{DS(ON)}$ guaranteed at $V_{GS} = 2.5V$) is required for applications that work close to this voltage. When these MOSFETs are used, make sure that the input supply to the LTC3772 is less than the absolute maximum V_{GS} rating.

The P-channel MOSFET’s on-resistance is chosen based on the required load current. The maximum average output load current $I_{OUT(MAX)}$ is equal to the peak inductor current minus half the peak-to-peak ripple current I_{RIPPLE} . The LTC3772’s current comparator monitors the drain-to-source voltage V_{DS} of the P-channel MOSFET, which is sensed between the V_{IN} and SW pins. The peak inductor current is limited by the current threshold, set by the voltage on the I_{TH} pin of the current comparator. The voltage on the I_{TH} pin is internally clamped, which limits the maximum current sense threshold $\Delta V_{SENSE(MAX)}$ to approximately 175mV when I_{PRG} is floating (100mV when I_{PRG} is tied low; 250mV when I_{PRG} is tied high).

The output current that the LTC3772 can provide is given by:

$$I_{OUT(MAX)} = \frac{\Delta V_{SENSE(MAX)}}{R_{DS(ON)}} - \frac{I_{RIPPLE}}{2}$$

A reasonable starting point is setting ripple current I_{RIPPLE} to be 40% of $I_{OUT(MAX)}$. Rearranging the above equation yields:

$$R_{DS(ON)(MAX)} = \frac{5}{6} \cdot \frac{\Delta V_{SENSE(MAX)}}{I_{OUT(MAX)}}$$

for Duty Cycle < 20%.

However, for operation above 20% duty cycle, slope compensation has to be taken into consideration to select the appropriate value of $R_{DS(ON)}$ to provide the required amount of load current:

$$R_{DS(ON)(MAX)} = \frac{5}{6} \cdot \frac{\Delta V_{SENSE(MAX)} - SF}{I_{OUT(MAX)}}$$

where SF is a factor whose value is obtained from the curve in Figure 1.

These must be further derated to take into account the significant variation in on-resistance with temperature. The following equation is a good guide for determining the required $R_{DS(ON)MAX}$ at 25°C (manufacturer’s specification), allowing some margin for variations in the LTC3772 and external component values:

$$R_{DS(ON)(MAX)} = \frac{5}{6} \cdot 0.9 \cdot \frac{\Delta V_{SENSE(MAX)} - SF}{I_{OUT(MAX)} \cdot \rho_T}$$

The ρ_T is a normalizing term accounting for the temperature variation in on-resistance, which is typically about 0.4%/°C, as shown in Figure 2. Junction to case temperature T_{JC} is about 10°C in most applications. For a maximum ambient temperature of 70°C, using $\rho_{80°C} \sim 1.3$ in the above equation is a reasonable choice.

The required minimum $R_{DS(ON)}$ of the MOSFET is also governed by its allowable power dissipation. For applications that may operate the LTC3772 in dropout—i.e., 100%

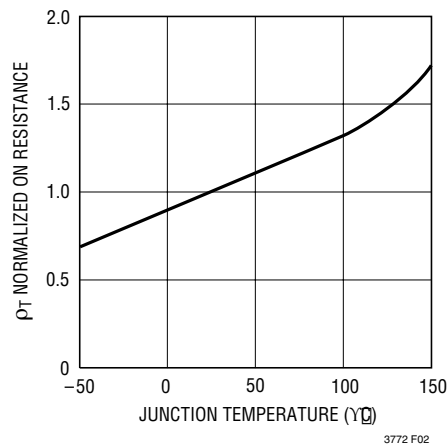

Figure 2. $R_{DS(ON)}$ vs Temperature

APPLICATIONS INFORMATION

duty cycle—at its worst case the required $R_{DS(ON)}$ is given by:

$$R_{DS(ON)(DC=100\%)} = \frac{P_P}{(I_{OUT(MAX)})^2 (1 + \delta_P)}$$

where P_P is the allowable power dissipation and δ_P is the temperature dependency of $R_{DS(ON)}$. $(1 + \delta_P)$ is generally given for a MOSFET in the form of a normalized $R_{DS(ON)}$ vs temperature curve, but $\delta_P = 0.005/^\circ\text{C}$ can be used as an approximation for low voltage MOSFETs.

In applications where the maximum duty cycle is less than 100% and the LTC3772 is in continuous mode, the $R_{DS(ON)}$ is governed by:

$$R_{DS(ON)} \cong \frac{P_P}{(DC)I_{OUT}^2 (1 + \delta_P)}$$

where DC is the maximum operating duty cycle of the LTC3772.

Inductor Value Calculation

The operating frequency and inductor selection are inter-related in that higher operating frequencies permit the use of a smaller inductor for the same amount of inductor ripple current. However, this is at the expense of efficiency due to an increase in MOSFET gate charge losses.

The inductance value also has a direct effect on ripple current. The ripple current, I_{RIPPLE} , decreases with higher inductance or frequency and increases with higher V_{IN} or V_{OUT} . The inductor's peak-to-peak ripple current is given by:

$$I_{RIPPLE} = \frac{V_{IN} - V_{OUT}}{f(L)} \left(\frac{V_{OUT} + V_D}{V_{IN} + V_D} \right)$$

where f is the operating frequency. Accepting larger values of I_{RIPPLE} allows the use of low inductances, but results in higher output voltage ripple and greater core losses. A reasonable starting point for setting ripple current is $I_{RIPPLE} = 0.4(I_{OUT(MAX)})$. Remember, the maximum I_{RIPPLE} occurs at the maximum input voltage.

Inductor Core Selection

Once the inductance value is determined, the type of inductor must be selected. Actual core loss is independent of core size for a fixed inductor value, but it is very dependent on inductance selected. As inductance increases, core losses go down. Unfortunately, increased inductance requires more turns of wire and therefore copper losses will increase.

Ferrite designs have very low core loss and are preferred at high switching frequencies, so design goals can concentrate on copper loss and preventing saturation. Ferrite core material saturates “hard,” which means that inductance collapses abruptly when the peak design current is exceeded. This results in an abrupt increase in inductor ripple current and consequent output voltage ripple. Do not allow the core to saturate!

Different core materials and shapes will change the size/current and price/current relationship of an inductor. Toroid or shielded pot cores in ferrite or permalloy materials are small and don't radiate much energy, but generally cost more than powdered iron core inductors with similar characteristics. The choice of which style inductor to use mainly depends on the price vs size requirements and any radiated field/EMI requirements. New designs for surface mount inductors are available from Coiltronics, Coilcraft, Toko and Sumida.

Output Diode Selection

The catch diode carries load current during the off-time. The average diode current is therefore dependent on the P-channel switch duty cycle. At high input voltages the diode conducts most of the time. As V_{IN} approaches V_{OUT} the diode conducts only a small fraction of the time. The most stressful condition for the diode is when the output is short-circuited. Under this condition the diode must safely handle I_{PEAK} at close to 100% duty cycle. Therefore, it is important to adequately specify the diode peak current and average power dissipation so as not to exceed the diode ratings.

APPLICATIONS INFORMATION

Under normal load conditions, the average current conducted by the diode is:

$$I_D = \left(\frac{V_{IN} - V_{OUT}}{V_{IN} + V_D} \right) I_{OUT}$$

The allowable forward voltage drop in the diode is calculated from the maximum short-circuit current as:

$$V_F \approx \frac{P_D}{I_{SC(MAX)}}$$

where P_D is the allowable power dissipation and will be determined by efficiency and/or thermal requirements.

A fast switching diode must also be used to optimize efficiency. Schottky diodes are a good choice for low forward drop and fast switching times. Remember to keep lead length short and observe proper grounding to avoid ringing and increased dissipation.

An additional consideration in applications where low no-load quiescent current is critical is the reverse leakage current of the diode at the regulated output voltage. A leakage greater than several microamperes can represent a significant percentage of the total input current.

C_{IN} and C_{OUT} Selection

The input capacitance, C_{IN} , is needed to filter the trapezoidal current at the source of the top MOSFET. To prevent large ripple voltage, a low ESR input capacitor sized for the maximum RMS current should be used. RMS current is given by:

$$I_{RMS} = I_{OUT(MAX)} \frac{V_{OUT}}{V_{IN}} \sqrt{\frac{V_{IN}}{V_{OUT}} - 1}$$

This formula has a maximum at $V_{IN} = 2V_{OUT}$, where $I_{RMS} = I_{OUT}/2$. This simple worst-case condition is commonly used for design because even significant deviations do not offer much relief. Note that ripple current ratings from capacitor manufacturers are often based on only 2000 hours of life which makes it advisable to further derate the capacitor, or choose a capacitor rated at a higher temperature than required. Several capacitors may also be paralleled to meet size or height requirements in the design.

The output filtering capacitor C smooths out current flow from the inductor to the load, help maintain a steady output voltage during transient load changes and reduce output voltage ripple. The capacitors must be selected with sufficiently low ESR to minimize voltage ripple and load step transients and sufficiently bulk capacitance to ensure the control loop stability.

The output ripple, ΔV_{OUT} , is determined by:

$$\Delta V_{OUT} \leq \Delta I_L \left(ESR + \frac{1}{8fC_{OUT}} \right)$$

The output ripple is highest at maximum input voltage since DIL increases with input voltage. Multiple capacitors placed in parallel may be needed to meet the ESR and RMS current handling requirements. Dry tantalum, special polymer, aluminum electrolytic and ceramic capacitors are all available in surface mount packages. Special polymer capacitors offer very low ESR but have lower capacitance density than other types. Tantalum capacitors have the highest capacitance density but it is important to only use types that have been surge tested for use in switching power supplies. Aluminum electrolytic capacitors have significantly higher ESR but can be used in cost-sensitive applications provided that consideration is given to ripple current ratings and long term reliability. Ceramic capacitors have excellent low ESR characteristics but can have a high voltage coefficient and audible piezoelectric effects. The high Q of ceramic capacitors with trace inductance can also lead to significant ringing.

Using Ceramic Input and Output Capacitors

Higher values, lower cost ceramic capacitors are now becoming available in smaller case sizes. Their high ripple current, high voltage rating and low ESR make them ideal for switching regulator applications. However, care must be taken when these capacitors are used at the input and output. When a ceramic capacitor is used at the input and the power is supplied by a wall adapter through long wires, a load step at the output can induce ringing at the input, V_{IN} . At best, this ringing can couple to the output and be mistaken as loop instability. At worst, a sudden inrush of current through the long wires can potentially cause a voltage spike at V_{IN} large enough to damage the part.

APPLICATIONS INFORMATION

For ceramic capacitor, use X7R or X5R types, do not use Y5V. The choices include Murata GRM series, TDK C2012 and Taiyo-Yuden JMK series.

Setting Output Voltage

The LTC3772 output voltages are each set by an external feedback resistor divider carefully placed across the output as shown in Figure 3. The regulated output voltage is determined by:

$$V_{OUT} = 0.8V \cdot \left(1 + \frac{R_B}{R_A}\right)$$

To improve the frequency response, a feed-forward capacitor, C_{FF} , may be used. Great care should be taken to route the V_{FB} line away from noise sources, such as the inductor or the SW line.

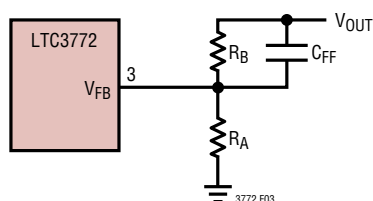

Figure 3. Setting Output Voltage

Efficiency Considerations

The efficiency of a switching regulator is equal to the output power divided by the input power times 100%. It is often useful to analyze individual losses to determine what is limiting the efficiency and which change would produce the most improvement. Efficiency can be expressed as:

$$\text{Efficiency} = 100\% - (\eta_1 + \eta_2 + \eta_3 + \dots)$$

where η_1 , η_2 , etc. are the individual losses as a percentage of input power.

Although all dissipative elements in the circuit produce losses, four main sources usually account for most of the losses in LTC3772 circuits: 1) LTC3772 DC bias current, 2) MOSFET gate charge current, 3) I^2R losses and 4) voltage drop of the output diode.

1. The V_{IN} current is the DC supply current, given in the electrical characteristics, that excludes MOSFET driver and control currents. V_{IN} current results in a small loss which increases with V_{IN} .
2. MOSFET gate charge current results from switching the gate capacitance of the power MOSFET. Each time a MOSFET gate is switched from low to high to low again, a packet of charge dQ moves from V_{IN} to ground. The resulting dQ/dt is a current out of V_{IN} that is typically much larger than the DC supply current. In continuous mode, $I_{GATECHG} = (f)(dQ)$.
3. I^2R losses are predicted from the DC resistances of the MOSFET, inductor and current shunt. In continuous mode the average output current flows through L but is “chopped” between the P-channel MOSFET (in series with R_{SENSE}) and the output diode. The MOSFET $R_{DS(ON)}$ plus R_{SENSE} multiplied by duty cycle can be summed with the resistances of L and R_{SENSE} to obtain I^2R losses.
4. The output diode is a major source of power loss at high currents and gets worse at high input voltages. The diode loss is calculated by multiplying the forward voltage times the diode duty cycle multiplied by the load current. For example, assuming a duty cycle of 50% with a Schottky diode forward voltage drop of 0.4V, the loss increases from 0.5% to 8% as the load current increases from 0.5A to 2A.
5. Transition losses apply to the external MOSFET and increase at higher operating frequencies and input voltages. Transition losses can be estimated from:

$$\text{Transition Loss} = 2(V_{IN})^2 I_{O(MAX)} C_{RSS}(f)$$

Other losses including C_{IN} and C_{OUT} ESR dissipative losses, and inductor core losses, generally account for less than 2% total additional loss.

Foldback Current Limiting

As described in the Output Diode Selection, the worst-case dissipation occurs with a short-circuited output when the diode conducts the current limit value almost continuously.

APPLICATIONS INFORMATION

To prevent excessive heating in the diode, foldback current limiting can be added to reduce the current in proportion to the severity of the fault.

Foldback current limiting is implemented by adding diodes D_{FB1} and D_{FB2} between the output and the I_{TH}/RUN pin as shown in Figure 4. In a hard short ($V_{OUT} = 0V$), the current will be reduced to approximately 50% of the maximum output current.

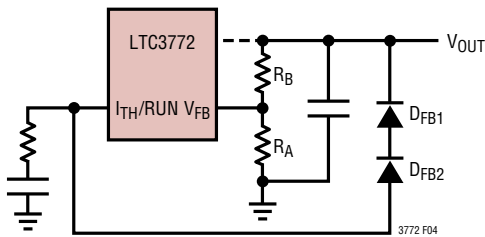

Figure 4. Foldback Current Limiting

Checking Transient Response

The regulator loop response can be checked by looking at the load transient response. Switching regulators take several cycles to respond to a step in load current. When a load step occurs, V_{OUT} immediately shifts by an amount equal to $(\Delta I_{LOAD})(ESR)$, where ESR is the effective series resistance of C_{OUT} . ΔI_{LOAD} also begins to charge or discharge C_{OUT} , which generates a feedback error signal. The regulator loop then returns V_{OUT} to its steady-state value. During this recovery time, V_{OUT} can be monitored for overshoot or ringing. OPTI-LOOP compensation allows the transient response to be optimized over a wide range of output capacitance and ESR values.

The I_{TH} series R_C - C_C filter (see Functional Diagram) sets the dominant pole-zero loop compensation. The I_{TH} external components shown in the Figure 5 circuit will provide an adequate starting point for most applications. The values can be modified slightly (from 0.2 to 5 times their suggested values) to optimize transient response once the final PC layout is done and the particular output capacitor type and value have been determined. The output capacitors need to be decided upon because the various types

and values determine the loop feedback factor gain and phase. An output current pulse of 20% to 100% of full load current having a rise time of $1\mu s$ to $10\mu s$ will produce output voltage and I_{TH} pin waveforms that will give a sense of the overall loop stability. The gain of the loop will be increased by increasing R_C , and the bandwidth of the loop will be increased by decreasing C_C . The output voltage settling behavior is related to the stability of the closed-loop system and will demonstrate the actual overall supply performance. For a detailed explanation of optimizing the compensation components, including a review of control loop theory, refer to Application Note 76.

A second, more severe transient is caused by switching in loads with large ($>1\mu F$) supply bypass capacitors. The discharged bypass capacitors are effectively put in parallel with C_{OUT} , causing a rapid drop in V_{OUT} . No regulator can deliver enough current to prevent this problem if the load switch resistance is low and it is driven quickly. The only solution is to limit the rise time of the switch drive so that the load rise time is limited to approximately $(25)(C_{LOAD})$. Thus a $10\mu F$ capacitor would require a $250\mu s$ rise time, limiting the charging current to about 200mA.

Minimum On-Time Considerations

Minimum on-time, $t_{ON(MIN)}$, is the smallest amount of time that the LTC3772 is capable of turning the top MOSFET on and then off. It is determined by internal timing delays and the gate charge required to turn on the top MOSFET. The minimum on-time for the LTC3772 is about 250ns. Low duty cycle and high frequency applications may approach this minimum on-time limit and care should be taken to ensure that:

$$t_{ON(MIN)} < \frac{V_{OUT}}{f \cdot V_{IN}}$$

If the duty cycle falls below what can be accommodated by the minimum on-time, the LTC3772 will begin to skip cycles. The output voltage will continue to be regulated, but the ripple current and ripple voltage will increase.

TYPICAL APPLICATIONS

550kHz Micropower 4A Step-Down DC/DC Converter

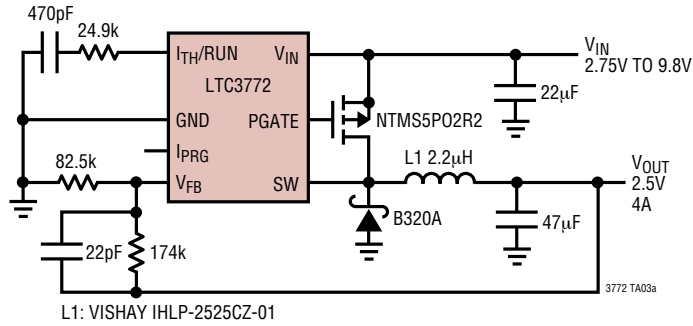

Efficiency vs Load Current

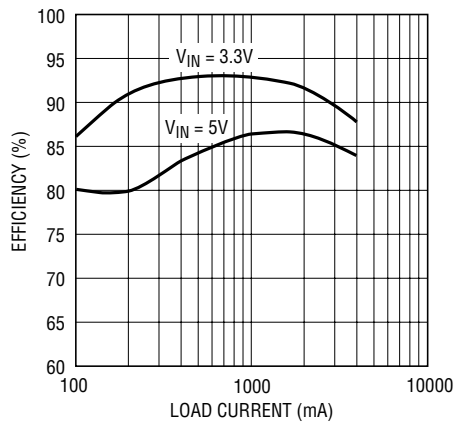

3772 TA03b

Start-Up

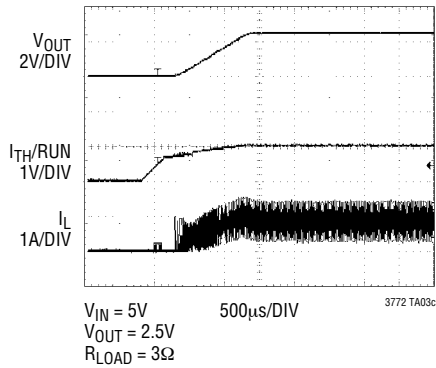

3772 TA03c

Load Step

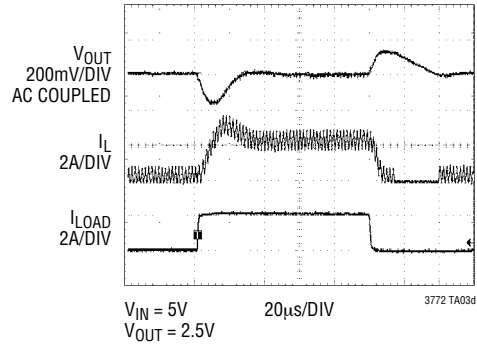

3772 TA03d

TYPICAL APPLICATIONS

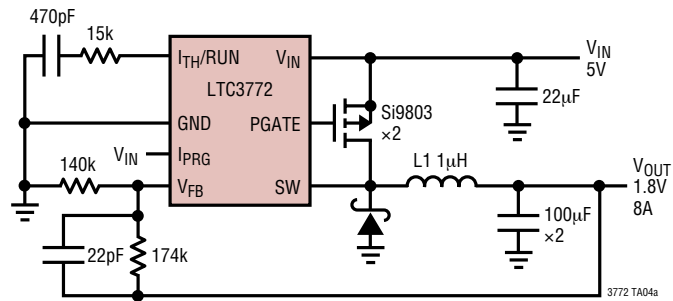
550kHz Micropower $5V_{IN}$ to $1.8V_{OUT}$ at 8A DC/DC Converter

PACKAGE DESCRIPTION

DDB Package
8-Lead Plastic DFN (3mm × 2mm)
 (Reference LTC DWG # 05-08-1702)

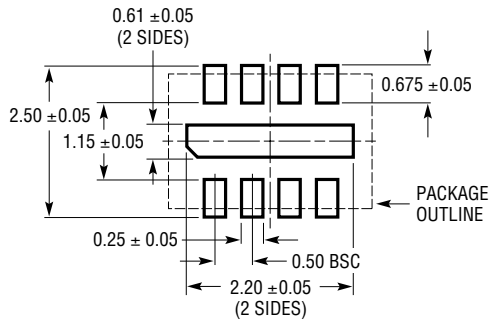

RECOMMENDED SOLDER PAD PITCH AND DIMENSIONS

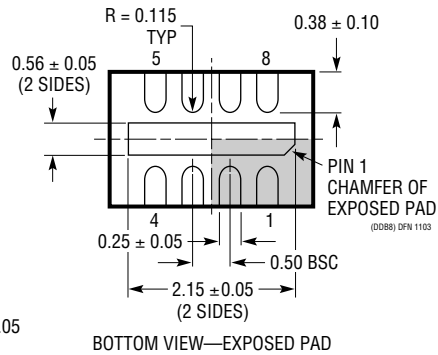
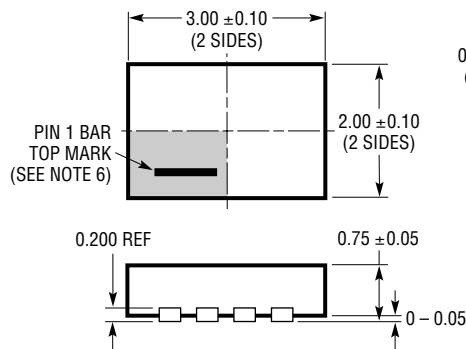

NOTE:

1. DRAWING CONFORMS TO VERSION (WECD-1) IN JEDEC PACKAGE OUTLINE M0-229
2. DRAWING NOT TO SCALE
3. ALL DIMENSIONS ARE IN MILLIMETERS
4. DIMENSIONS OF EXPOSED PAD ON BOTTOM OF PACKAGE DO NOT INCLUDE MOLD FLASH. MOLD FLASH, IF PRESENT, SHALL NOT EXCEED 0.15mm ON ANY SIDE
5. EXPOSED PAD SHALL BE SOLDER PLATED
6. SHADED AREA IS ONLY A REFERENCE FOR PIN 1 LOCATION ON THE TOP AND BOTTOM OF PACKAGE

PACKAGE DESCRIPTION

TS8 Package
8-Lead Plastic TSOT-23
 (Reference LTC DWG # 05-08-1637)

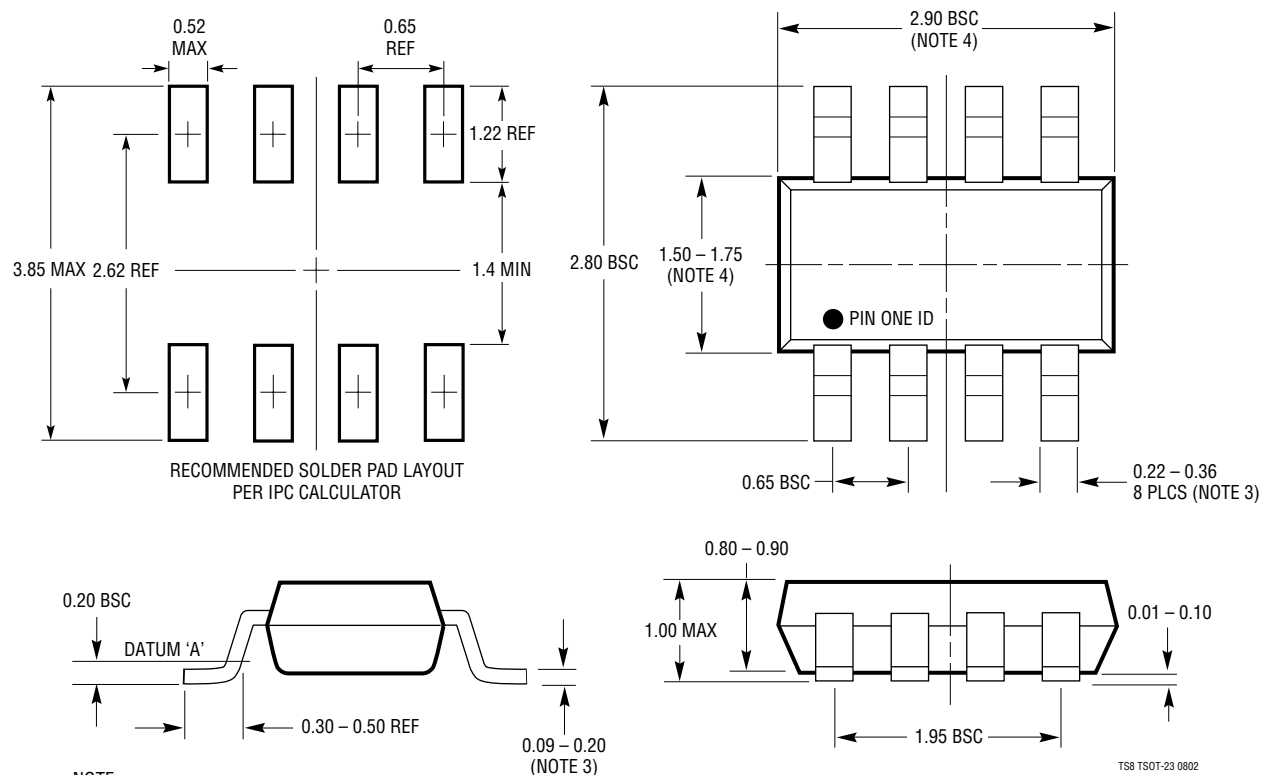

NOTE:

1. DIMENSIONS ARE IN MILLIMETERS
2. DRAWING NOT TO SCALE
3. DIMENSIONS ARE INCLUSIVE OF PLATING
4. DIMENSIONS ARE EXCLUSIVE OF MOLD FLASH AND METAL BURR
5. MOLD FLASH SHALL NOT EXCEED 0.254mm
6. JEDEC PACKAGE REFERENCE IS MO-193

TYPICAL APPLICATION

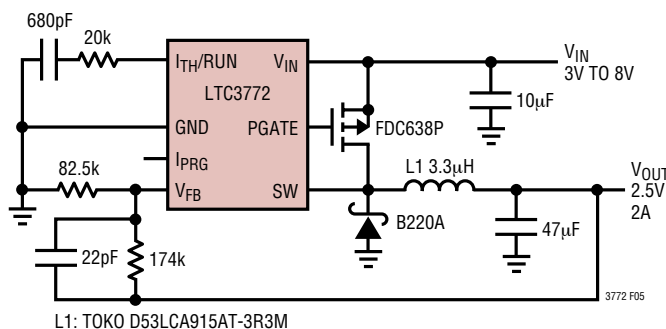

Figure 5. 550kHz Micropower Step-Down DC/DC Converter

RELATED PARTS

PART NUMBER	DESCRIPTION	COMMENTS
LTC1624	High Efficiency SO-8 N-Channel Switching Regulator Controller	N-Channel Drive, $3.5V \leq V_{IN} \leq 36V$
LTC1625	No R_{SENSE}^{TM} Synchronous Step-Down Regulator	97% Efficiency, No Sense Resistor
LT [®] 1765	25V, 2.75A (I_{OUT}), 1.25MHz Step-Down Converter	$3V \leq V_{IN} \leq 25V$, $V_{OUT} \geq 1.2V$, SO-8 and TSSOP16 Packages
LTC1771	Ultra-Low Supply Current Step-Down DC/DC Controller	10µA Supply Current, 93% Efficiency, $1.23V \leq V_{OUT} \leq 18V$; $2.8V \leq V_{IN} \leq 20V$
LTC1772/LTC1772B	550kHz ThinSOT Step-Down DC/DC Controllers	$2.5V \leq V_{IN} \leq 9.8V$, $V_{OUT} \geq 0.8V$, $I_{OUT} \leq 6A$
LTC1778/LTC1778-1	No R_{SENSE} Current Mode Synchronous Step-Down Controllers	$4V \leq V_{IN} \leq 36V$, $0.8V \leq V_{OUT} \leq (0.9)(V_{IN})$, I_{OUT} Up to 20A
LTC1872/LTC1872B	550kHz ThinSOT Step-Up DC/DC Controllers	$2.5V \leq V_{IN} \leq 9.8V$; 90% Efficiency
LTC3411/LTC3412	1.25/2.5A Monolithic Synchronous Step-Down Converter	95% Efficiency, $2.5V \leq V_{IN} \leq 5.5V$, $V_{OUT} \geq 0.8V$, TSSOP16 Exposed Pad Package
LTC3440	600mA (I_{OUT}), 2MHz Synchronous Buck-Boost DC/DC Converter	$2.5V \leq V_{IN} \leq 5.5V$, Single Inductor
LTC3736	Dual, 2-Phase, No R_{SENSE} Synchronous Controller with Output Tracking	V_{IN} : 2.75V to 9.8V, I_{OUT} Up to 5A, 4mm × 4mm QFN Package
LTC3736-1	Dual, 2-Phase, No R_{SENSE} Synchronous Controller with Spread Spectrum	V_{IN} : 2.75V to 9.8V, Spread Spectrum Operation, Output Voltage Tracking, 4mm × 4mm QFN Package
LTC3737	Dual, 2-Phase, No R_{SENSE} Controller with Output Tracking	V_{IN} : 2.75V to 9.8V, I_{OUT} Up to 5A, 4mm × 4mm QFN Package
LTC3776	Dual, 2-Phase, No R_{SENSE} Synchronous Controller for DDR/QDR Memory Termination	Provides V_{DDQ} and V_{TT} with one IC, $2.75V \leq V_{IN} \leq 9.8V$, Adjustable Constant Frequency with PLL Up to 850kHz, Spread Spectrum Operation, 4mm × 4mm QFN and 16-Lead SSOP Packages
LTC3808	No R_{SENSE} , Low EMI, Synchronous Step-Down Controller with Output Tracking	$2.75V \leq V_{IN} \leq 9.8V$, Spread Spectrum Operation, 3mm × 4mm DFN and 16-Lead SSOP Packages