

QUAD OPERATIONAL AMPLIFIER

The KA3303 series is a monolithic Quad operational amplifier consisting of four independent amplifiers. The device has high gain, internally frequency compensated operational amplifiers designed to operate from a single power supply or dual power supplies over a wide range of voltages. The common mode input range includes the negative supply, thereby eliminating the necessity for external biasing components in many applications.

FEATURES

- Output voltage can swing to GND or negative supply
- Wide power supply range;
 - Single supply of 3.0V to 36V
 - Dual supply of $\pm 1.5V$ to $\pm 18V$
- Electrical characteristics similar to the popular KA741
- CLASS AB output stage for minimal crossover distortion
- Short circuit protected output.

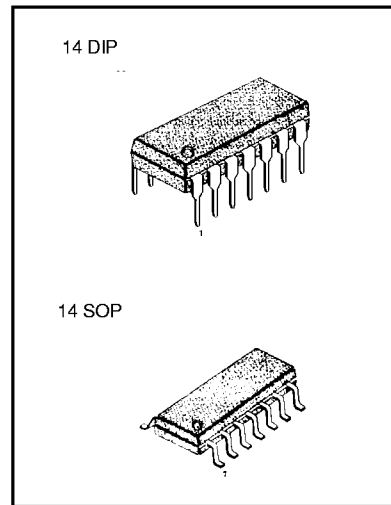

BLOCK DIAGRAM

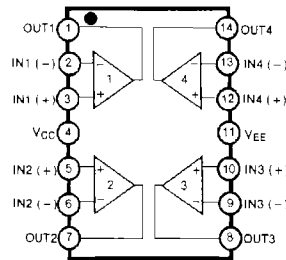

ORDERING INFORMATION

Device	Package	Operating Temperature
KA3403	14 DIP	0 ~ + 70 °C
KA3403D	14 SOP	
KA3303	14 DIP	-40 ~ + 85 °C
KA3303D	14 SOP	

SCHEMATIC DIAGRAM

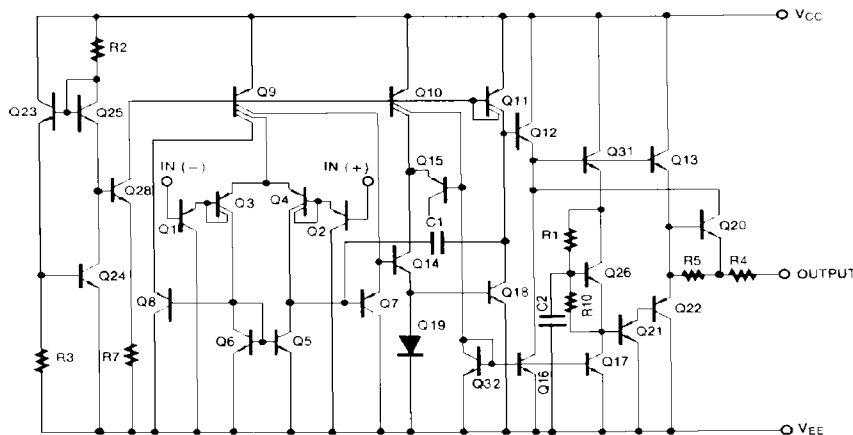

ABSOLUTE MAXIMUM RATINGS

Characteristic	Symbol	Value	Unit
Supply Voltage	V_{CC}	± 18 or $+36$	V
Differential Input Voltage	$V_{I(DIFF)}$	± 36	V
Input Voltage	V_I	± 18	V
Output Short Circuit Duration		Continuous	
Power Dissipation	P_D	670	mW
Operating Temperature KA3303	T_{OPR}	$-40 \sim +85$	$^{\circ}C$
KA3403		$0 \sim +70$	$^{\circ}C$
Storage Temperature	T_{STG}	$-65 \sim +150$	$^{\circ}C$

ELECTRICAL CHARACTERISTICS

($V_{CC} = +15V$, $V_{EE} = -15V$ for KA3403, $V_{CC} = +14V$, $V_{EE} = GND$ for KA3303, $T_A = 25^{\circ}C$, unless otherwise specified)

Characteristic	Symbol	Test Conditions	KA3303			KA3403			Unit
			Min	Typ	Max	Min	Typ	Max	
Input Offset Voltage	V_{IO}			1.5	8.0		1.5	10	mV
		NOTE 1			10			12	
Input Offset Current	I_{IO}			5	75		5	50	nA
		NOTE 1			150			100	
Input Bias Current	I_{BIAS}			30	200		30	200	nA
		NOTE 1			500			400	
Large Signal Voltage Gain	G_V	$V_{O(P-P)} = \pm 10V$ $R_L = 2K\Omega$	20	200		20	200		V/mV
		NOTE 1	15			15			
Input Impedance	R_i		0.3	1.0		0.3	1.0	M Ω	
Output Voltage Swing	$V_{O(P-P)}$	$R_L = 10K\Omega$	+12	+12.5		± 12	± 13.5		V
		$R_L = 2K\Omega$	+10	+12		± 10	± 13		
		$R_L = 2K\Omega$	NOTE 1	+10			± 10		
Input Common Mode Voltage Range	$V_{I(R)}$		12V - V_{EE}	12.5V - V_{EE}		13V - V_{EE}	13.5V - V_{EE}	V	
Common Mode Rejection Ratio	CMRR	$R_S \geq 10K\Omega$	70	90		70	90	dB	
Power Supply Current	I_{CC}	$V_{O(P)} = 0$, $R_L =$		2.8	7.0		2.3	7.0	mA
Output Short Circuit Current	I_{SC}	Each amplifier	± 10	± 30	± 45	± 10	± 20	± 45	mA
Positive Supply Rejection Ratio	PSRR(+)			30	150		30	150	$\mu V/V$
Negative Supply Rejection Ratio	PSRR(-)						30	150	$\mu V/V$
Average Temperature Coefficient of Input Offset Current	$\Delta I_{IO}/\Delta T$			50			50		pA/ $^{\circ}C$
Total Harmonic distortion	THD	$V_{CC} = 5V$, $V_{CE} = -5V$ $F = 1KHz$, Input level = 1.55Vp-p				-	0.1	0.4	%

ELECTRICAL CHARACTERISTICS (Continued)(V_{CC}= +15V, V_{EE}= -15V for KA3403. V_{CC}= +14V, V_{EE}=GND for KA3303, T_A=25°C, unless otherwise specified)

Characteristic	Symbol	Test Conditions	KA3303			KA3403			Unit
			Min	Typ	Max	Min	Typ	Max	
Input Offset Voltage Drift	$\Delta V_{IO}/\Delta T$			10			10		$\mu V/^\circ C$
Gain Bandwidth	GBW	G _V =1, R _L =2K Ω , V _{O(P-P)} =20V _{P-P} , THD=5%		9.0			9.0		KHz
Small Signal Bandwidth	BW	G _V =1, R _L =10K Ω , V _{O(P-P)} =50mV		1.0			1.0		MHz
Slew Rate	SR	G _V =1, V _I = -10V to +10V		0.4			0.4		V/ μs
Rise Time	t _{RES}	G _V =1, R _L =10K Ω , V _{O(P-P)} =50mV		0.35			0.35		μs
Fall Time	t _F	G _V =1, R _L =10K Ω , V _{O(P-P)} =50mV		0.35			0.35		μs
Over Shoot	OS	G _V =1, R _L =10K Ω , V _{O(P-P)} =50mV		20			20		%
Phase Margin	MPH	G _V =1, R _L =2K Ω , C _L =200pF		60			60		Degress
Crossover Distortion	CD	V _I =30mV _{P-P} , V _{O(P-P)} =2.0V _{P-P} , f=10KHz		1.0			1.0		5%

NOTE 1

KA3403: 0 \leq T_A \leq +70°CKA3303: -40 \geq T_A \geq +85°C**ELECTRICAL CHARACTERISTICS**(V_{CC}= 5.0V, V_{EE}= GND, T_A=25°C unless otherwise specified)

Characteristic	Symbol	Test Conditions	KA3303			KA3403			Unit
			Min	Typ	Max	Min	Typ	Max	
Input Offset Voltage	V _{IO}				10		2.0	10	mV
Input Offset Current	I _{IO}				75		30	50	nA
Input Bias Current	I _{BIAS}				500		200	500	nA
Large Signal Open Loop Voltage Gain	G _V	R _L = 2.0K Ω	10	200		10	200		V/mV
Power Supply Rejection Ratio	PSRR				150			150	$\mu V/V$
Output Voltage Range	V _{O(P-P)}	R _L = 10K Ω , V _{CC} = 5.0V	3.3	3.5		3.3	3.5		V
		R _L = 10K Ω , 5.0V \geq V _{CC} \geq 30V	V _{CC} -2.0	V _{CC} -1.7		V _{CC} -2.0	V _{CC} -1.7		
Supply Current	I _{CC}			2.5	7.0		2.5	7.0	mA
Channel Separation	CS	f = 1KHz to 20KHz		120			120		dB

TYPICAL PERFORMANCE CHARACTERISTICS

Fig. 1 OPEN LOOP FREQUENCY RESPONSE

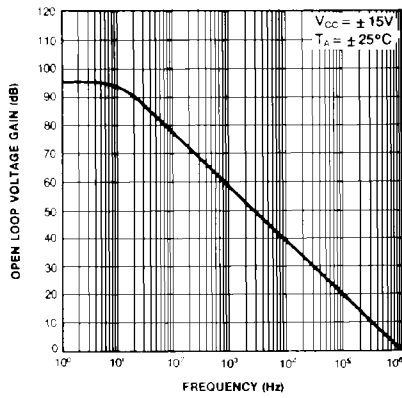

Fig. 2. Wave Response

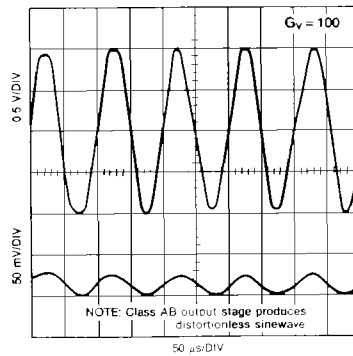

Fig. 3 OUTPUT SWING

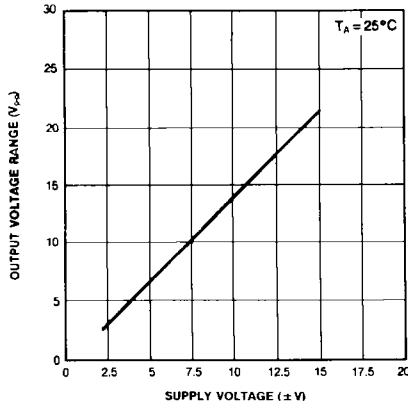

Fig. 4 OUTPUT VOLTAGE vs FREQUENCY

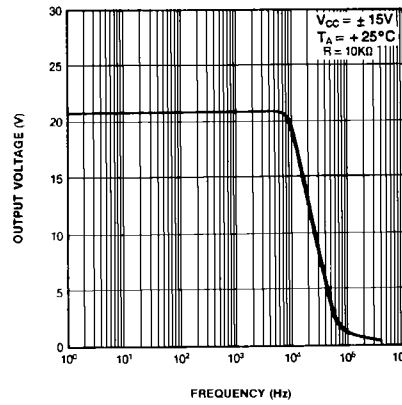

Fig. 5 INPUT BIAS CURRENT vs TEMPERATURE

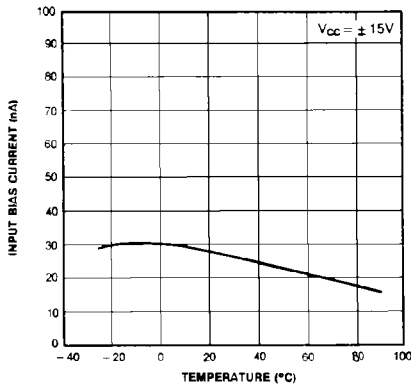
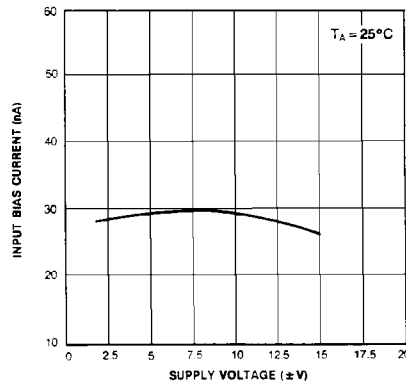

Fig. 6 INPUT BIAS CURRENT vs SUPPLY VOLTAGE



TRADEMARKS

The following are registered and unregistered trademarks Fairchild Semiconductor owns or is authorized to use and is not intended to be an exhaustive list of all such trademarks.

ACE ^x ™	ISOPLANAR™	UHC™
CoolFET™	MICROWIRE™	VCX™
CROSSVOLT™	POP™	
E ² CMOS™	PowerTrench™	
FACT™	QS™	
FACT Quiet Series™	Quiet Series™	
FAST®	SuperSOT™-3	
FASTr™	SuperSOT™-6	
GTO™	SuperSOT™-8	
HiSeC™	TinyLogic™	

DISCLAIMER

FAIRCHILD SEMICONDUCTOR RESERVES THE RIGHT TO MAKE CHANGES WITHOUT FURTHER NOTICE TO ANY PRODUCTS HEREIN TO IMPROVE RELIABILITY, FUNCTION OR DESIGN. FAIRCHILD DOES NOT ASSUME ANY LIABILITY ARISING OUT OF THE APPLICATION OR USE OF ANY PRODUCT OR CIRCUIT DESCRIBED HEREIN; NEITHER DOES IT CONVEY ANY LICENSE UNDER ITS PATENT RIGHTS, NOR THE RIGHTS OF OTHERS.

LIFE SUPPORT POLICY

FAIRCHILD'S PRODUCTS ARE NOT AUTHORIZED FOR USE AS CRITICAL COMPONENTS IN LIFE SUPPORT DEVICES OR SYSTEMS WITHOUT THE EXPRESS WRITTEN APPROVAL OF FAIRCHILD SEMICONDUCTOR CORPORATION. As used herein:

1. Life support devices or systems are devices or systems which, (a) are intended for surgical implant into the body, or (b) support or sustain life, or (c) whose failure to perform when properly used in accordance with instructions for use provided in the labeling, can be reasonably expected to result in significant injury to the user.
2. A critical component is any component of a life support device or system whose failure to perform can be reasonably expected to cause the failure of the life support device or system, or to affect its safety or effectiveness.

PRODUCT STATUS DEFINITIONS

Definition of Terms

Datasheet Identification	Product Status	Definition
Advance Information	Formative or In Design	This datasheet contains the design specifications for product development. Specifications may change in any manner without notice.
Preliminary	First Production	This datasheet contains preliminary data, and supplementary data will be published at a later date. Fairchild Semiconductor reserves the right to make changes at any time without notice in order to improve design.
No Identification Needed	Full Production	This datasheet contains final specifications. Fairchild Semiconductor reserves the right to make changes at any time without notice in order to improve design.
Obsolete	Not In Production	This datasheet contains specifications on a product that has been discontinued by Fairchild semiconductor. The datasheet is printed for reference information only.