

Vertical Female Connectors Type B

125 signal contacts
50 mm without multifunction block

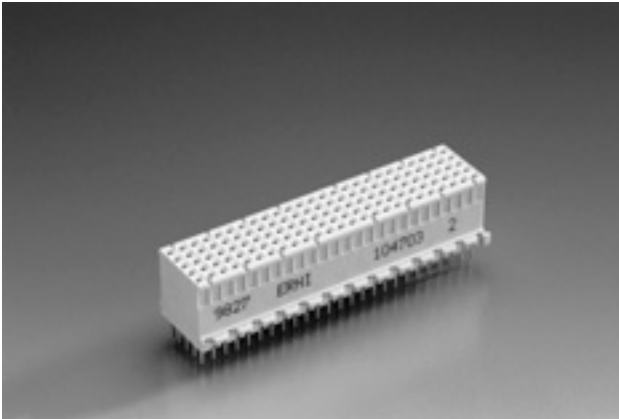

The ERmet type B vertical female connector provides 125 contacts in a 5 row x 25 position fully loaded configuration. Versions with optional “z” and “f” row shields are available as well as extended terminals for use in stacking applications with rear shrouds.

Two spacer heights are also available: 3.1 mm and 9.6 mm to provide additional component clearance.

The ERmet type B vertical female connector has an uninterrupted contact field and no multifunction cavity. This connector is not designed to be used alone, but is intended to be used with either a Type A or C female ERmet connector.

Dimensional drawings and board hole pattern

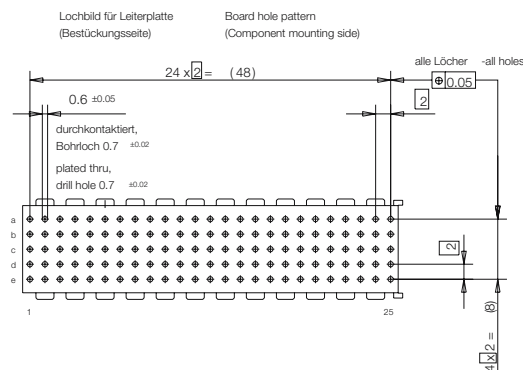
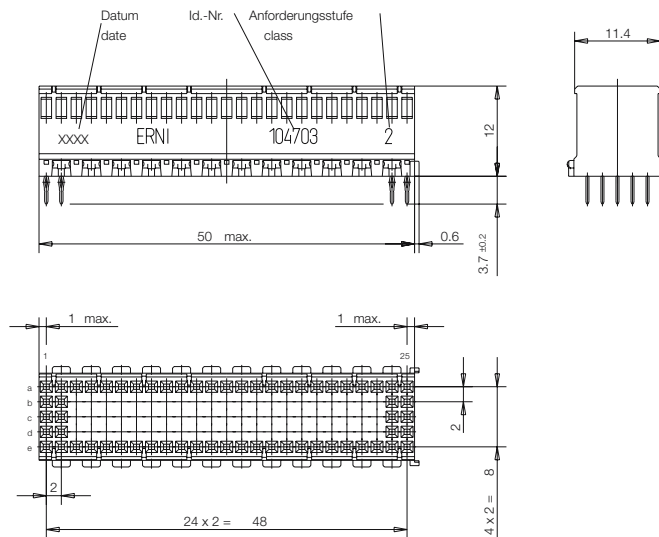

Note: The numbering on the connectors themselves is in accordance with the IEC 61076-4-101 standard. All dimensions in mm.

Vertical Female Connectors Type B

* Termination + Board To Board Distance

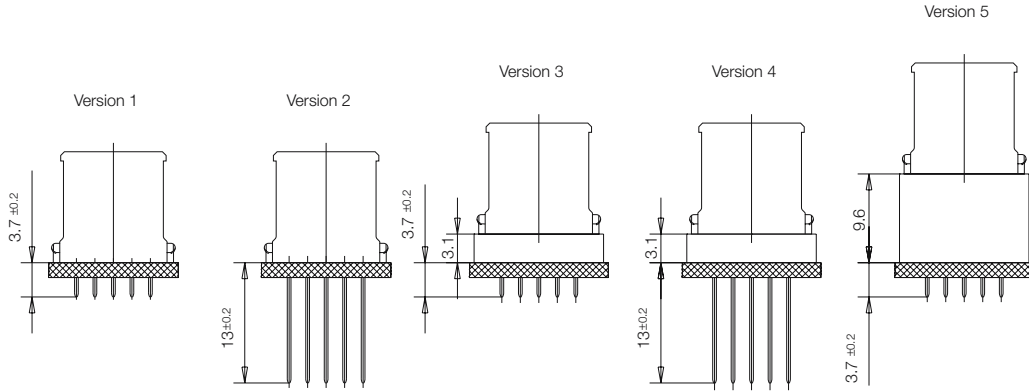

Version	Board To Board Distance *
1	15-16.5
2	15-16.5
3	18.4-20.0
4	18.4-20.0
5	25-26.5

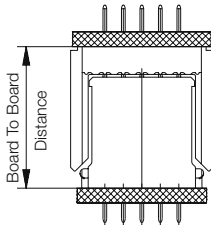

* based on contact level 1
 other board to board distances for remaining levels on request
 (Please contact our Customer Service)

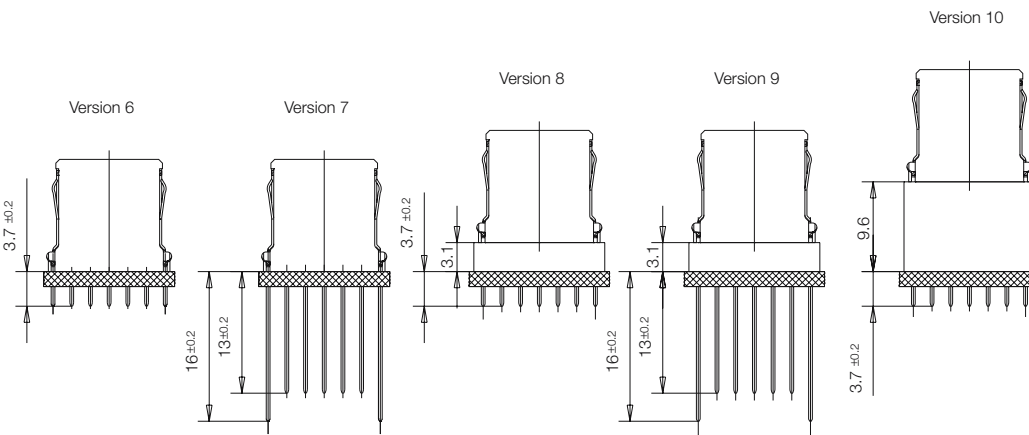

Version	Board To Board Distance *
6	15-16.5
7	15-16.5
8	18.4-20.0
9	18.4-20.0
10	25-26.5

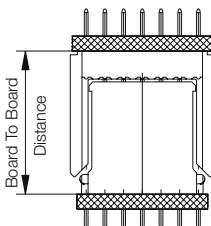

* based on contact level 1
 other board to board distances for remaining levels on request
 (Please contact our Customer Service)

Note: All dimensions in mm.

Vertical Female Connectors Type B

Ordering Information

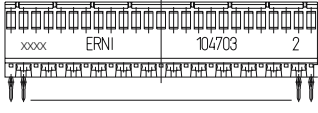
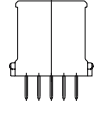
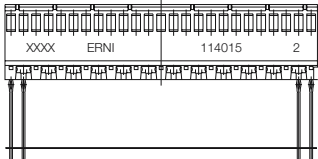
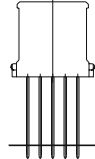
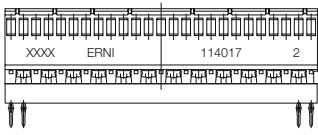
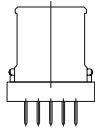
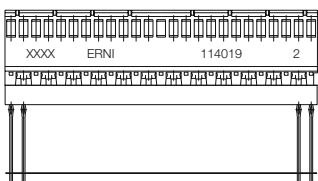
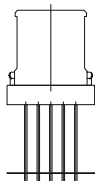
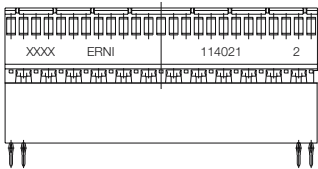
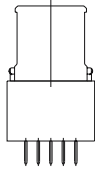
Configuration	Used For	No. of Pins	Part Number
Type B Without Shield, Without Peg Version 1 *  		125	104703
Type B Without Shield, Without Peg Version 2 *  		125	114015
Type B Without Shield, Without Peg Version 3 *  		125	114017
Type B Without Shield, Without Peg Version 4 *  		125	114019
Type B Without Shield, Without Peg Version 5 *  		125	114021





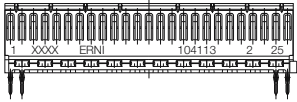
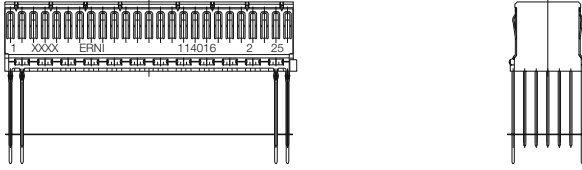
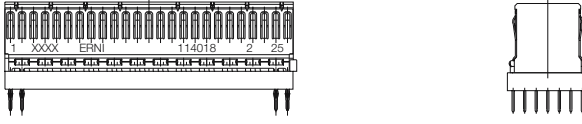
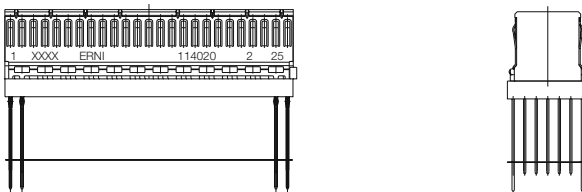
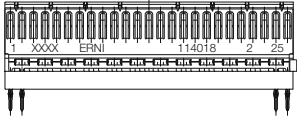

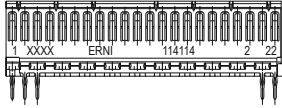

Vertical Female Connectors Type B

Ordering Information

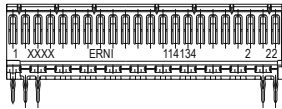
Configuration	Used For	No. of Pins	Part Number
Type B With Shield, Without Peg Version 6 * 		125	104113
Type B With Shield, Without Peg Version 7 * 		125	114016
Type B With Shield, Without Peg Version 8 * 		125	114018
Type B With Shield, Without Peg Version 9 * 		125	114020
Type B With Shield, Without Peg Version 10 * 		125	114022

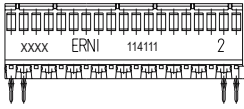
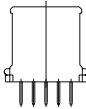
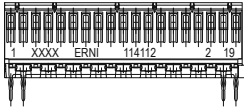
Vertical Female Connectors Type B

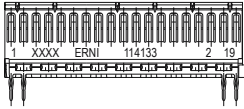
Ordering Information

Configuration	Used For	No. of Pins	Part Number
Type B With Shield, Without Peg Version 6 *			
 		110	114114
Type B With F-row Shield, Without Peg Version 6 *	CompactPCI™		
 	P2 / P4	110	114134
Type B Without Shield, Without Peg Version 1 *			
 		95	114111
Type B With Shield, Without Peg Version 6 *			
 		95	114112
Type B With F-row Shield, Without Peg Version 6 *	CompactPCI™		
 	P2 / P4	95	114133