

### FAST RECOVERY DIODES

### MAGN-A-pak™ Power Modules

#### Features

- Fast recovery time characteristics
- Electrically isolated base plate
- Industrial standard package
- Simplified mechanical designs, rapid assembly
- High surge capability
- Large creepage distances
- 3000 V<sub>RMS</sub> isolating voltage
- UL E78996 approved 

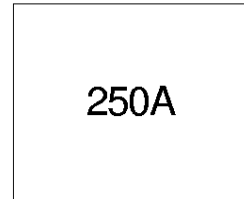

#### Description

The IRK.L240 Series of MAGN-A-paks uses fast recovery power diodes in four basic configurations. The semiconductors are electrically isolated from the metal base, allowing common heatsinks and compact assemblies to be built. Application includes power supplies, battery chargers, welders, motor controls and general industrial current rectification. These modules are intended for those applications where fast recovery characteristics are required.

#### Major Ratings and Characteristics

Parameters	IRK.L240		Units
	S10/S20	S30	
$I_{F(AV)}$	250	240	A
@ $T_C$	100	100	°C
$I_{F(RMS)}$	392	377	A
$I_{FSM}$			
@ 50Hz	8000	7500	A
@ 60Hz	8400	7850	A
$I^2t$			
@ 50Hz	322	280	KA <sup>2</sup> s
@ 60Hz	294	256	KA <sup>2</sup> s
$I^2\sqrt{t}$	3220	2800	KA <sup>2</sup> √s
$V_{RRM}$	up to 2500		V
$T_J$ range	-40 to 150		°C

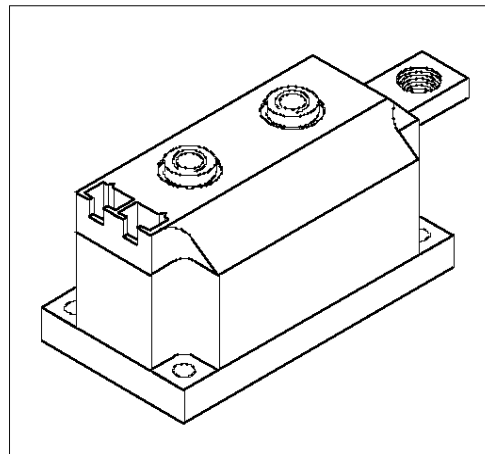

**ELECTRICAL SPECIFICATIONS**

**Voltage Ratings**

Typenumber	Voltage Code	$t_{rr}$ Code	$V_{RRM}$ , maximum repetitive peak reverse voltage V	$V_{RSM}$ , maximum non-repetitive peak reverse voltage V	$I_{RRM}$ max. @ 150°C mA
IRK.L240	06	S10	600	700	50
	10	S10	1000	1100	
	12	S20	1200	1300	
	14	S20	1400	1500	
	20	S30	2000	2100	
	25	S30	2500	2600	

**Forward Conduction**

Parameter	IRK.L240		Units	Conditions		
	S10/S20	S30				
$I_{F(AV)}$ Max. average forward current @ Case temperature	250 100	240 100	A °C	180° conduction, half sine wave		
$I_{F(RMS)}$ Max. RMS forward current	392	377	A	as AC switch		
$I_{FSM}$ Max. peak, one-cycle forward, non-repetitive surge current	8000	7500	A	t = 10ms	No voltage reappplied	Sinusoidal half wave, Initial $T_J = T_J$ max
	8400	7850		t = 8.3ms	reappplied	
	6750	6300		t = 10ms	100% $V_{RRM}$ reappplied	
	7100	6600		t = 8.3ms	reappplied	
$I^2t$ Maximum $I^2t$ for fusing	322	280	KA <sup>2</sup> s	t = 10ms	No voltage reappplied	Initial $T_J = T_J$ max
	294	256		t = 8.3ms	reappplied	
	228	198		t = 10ms	100% $V_{RRM}$ reappplied	
	208	181		t = 8.3ms	reappplied	
$F\sqrt{t}$ Maximum $F\sqrt{t}$ for fusing	3220	2800	KA <sup>2</sup> /s	t = 0.1 to 10ms, no voltage reappplied		
$V_{F(TO)1}$ Low level value of threshold voltage	0.98	0.98	V	$(16.7\% \times \pi \times I_{F(AV)} < I < \pi \times I_{F(AV)}) T_J = T_J$ max		
$V_{F(TO)2}$ High level value of threshold voltage	1.31	1.31	V	$(I > \pi \times I_{F(AV)}) T_J = T_J$ max.		
$r_{r1}$ Low level value of forward slope resistance	0.75	0.97	mΩ	$(16.7\% \times \pi \times I_{F(AV)} < I < \pi \times I_{F(AV)}) T_J = T_J$ max		
$r_{r2}$ High level value of forward slope resistance	0.41	0.60	mΩ	$(I > \pi \times I_{F(AV)}) T_J = T_J$ max.		
$V_{FM}$ Max. forward voltage drop	1.57	1.75	V	$I_{FM} = 800, T_J = 150^\circ\text{C}$ tp = 10 ms Av. power = $V_{F(TO)} \times I_{F(AV)} + r_f \times (I_{F(RMS)})^2$		

**Blocking**

$I_{RRM}$ Max. peak reverse leakage current	50	mA	$T_J = 150^\circ\text{C}$ , leakage current
$V_{INS}$ RMS isolation voltage	3000	V	50Hz, circuit to base, all terminals shorted, 25°C, t = 1s

**Thermal and Mechanical Specifications**

$T_J$	Max. junction operating temperature	-40 to 150	°C	
$T_{stg}$	Max. storage temperature range	-40 to 150	°C	
$R_{thJ-C}$	Max. internal thermal resistance junction to case	0.125	K/W	Per junction, DC operation
$R_{thC-S}$	Thermal resistance, case to heatsink	0.02	K/W	Mounting surface flat, smooth and greased Permodule
T	Mounting torque $\pm 10\%$ MAP to heatsink	4 to 6	Nm	A mounting compound is recommended and the torque should be rechecked after a period of about 3 hours to allow for the spread of the compound
	Busbar to MAP	8 to 10	Nm	
wt	Approximate weight	850(30)	g(oz)	
	Case style	MAGN-A-pak		

**$\Delta R$  Conduction (per Junction)**

(The following table shows the increment of thermal resistance  $R_{thJ-C}$  when devices operate at different conduction angles than DC)

Conduction angle	Sinusoidal conduction	Rectangular conduction	Units	Conditions
180°	0.008	0.007	K/W	$T_J = T_{J \text{ max.}}$
120°	0.010	0.011	K/W	
90°	0.013	0.015	K/W	
60°	0.019	0.020	K/W	
30°	0.032	0.033	K/W	

**Recovery Characteristics**

Code	Test conditions			Typ. values @ $T_J = 150^\circ\text{C}$	
	$I_{pk}$ (A)	$di/dt$ (A/ $\mu\text{s}$ )	$V_r$ (V)	$Q_{rr}$ ( $\mu\text{C}$ )	$I_{rr}$ (A)
S10	500	100	50	135	100
S20	"	"	"	250	145
S30	"	"	"	360	200

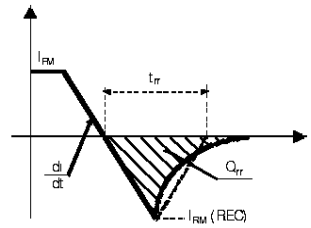

**Ordering Information Table**

Device Code							
IRK	D	L	240	-	25	S30	N
①	②	③	④		⑤	⑥	⑦
<b>1</b>	- Module type						
<b>2</b>	- Circuit configuration (See Outline Table)						
<b>3</b>	- L = Fast recovery diode						
<b>4</b>	- Current rating						
<b>5</b>	- Voltage code: Code x 100 = VRRM (See Voltage Ratings Table)						
<b>6</b>	- $t_{rr}$ code (See Recovery Characteristics Table)						
<b>7</b>	- None = Standard devices						
	N = Aluminum Nitride substrate						

S10 = 1000 ns  
S20 = 2000 ns  
S30 = 3000 ns

# IRK.L240 Series

Bulletin I27094 rev. A 09/97

International  
**IRF** Rectifier

## Outline Table

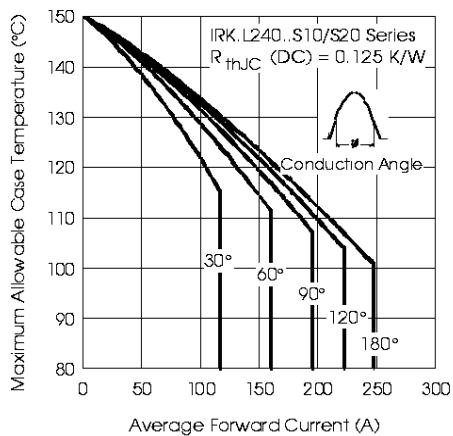
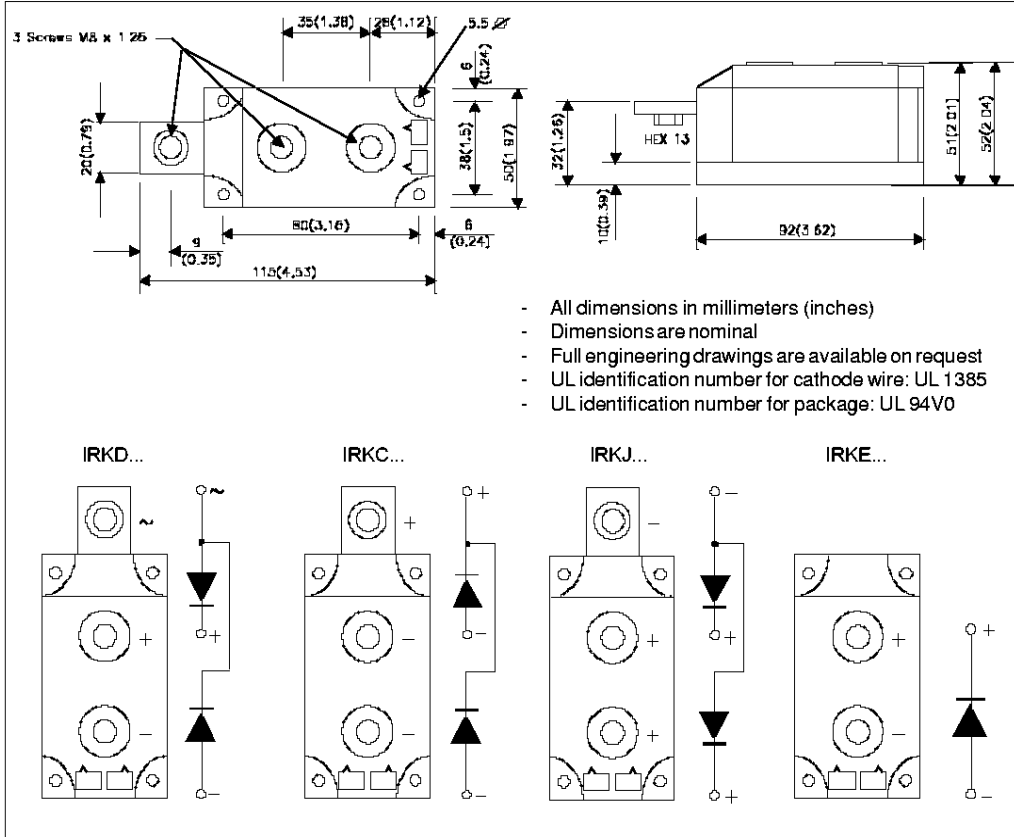

Fig. 1 - Current Ratings Characteristics

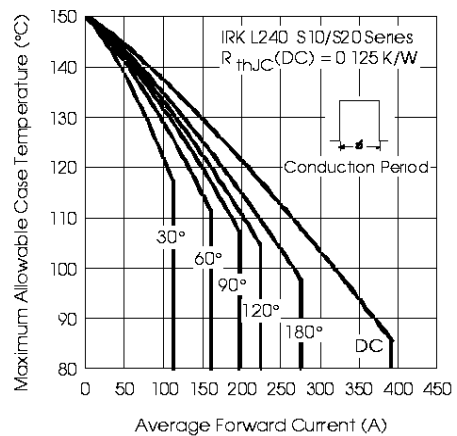

Fig. 2 - Current Ratings Characteristics

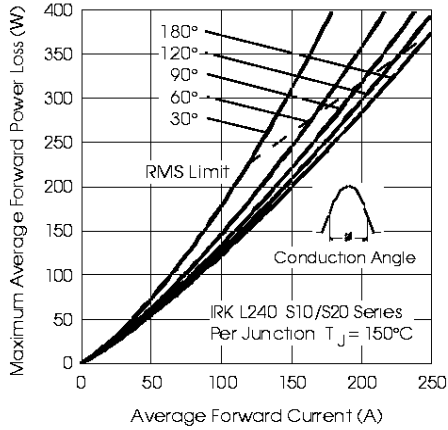

Fig. 3 - Forward Power Loss Characteristics

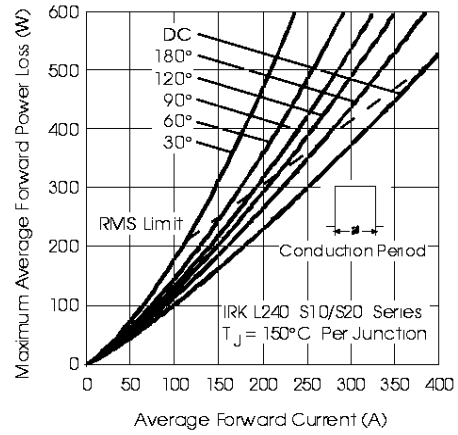

Fig. 4 - Forward Power Loss Characteristics

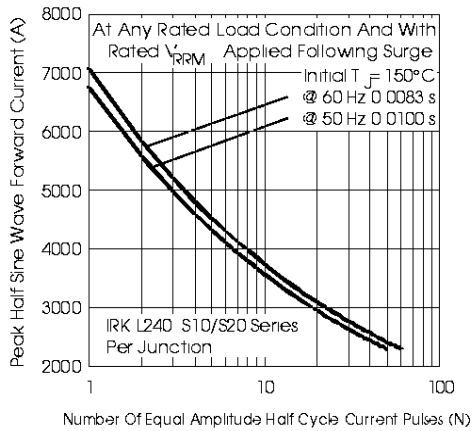

Fig. 5 - Maximum Non-Replicative Surge Current

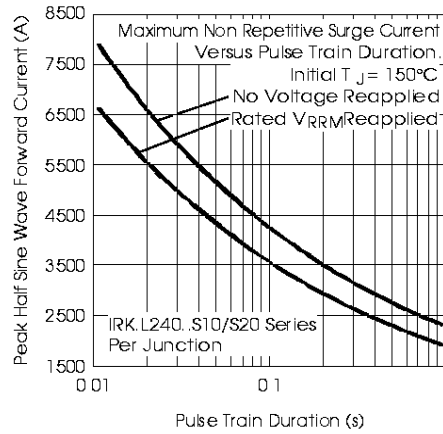

Fig. 6 - Maximum Non-Replicative Surge Current

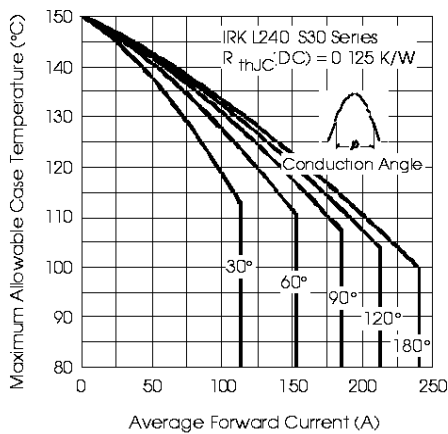

Fig. 7 - Current Ratings Characteristics

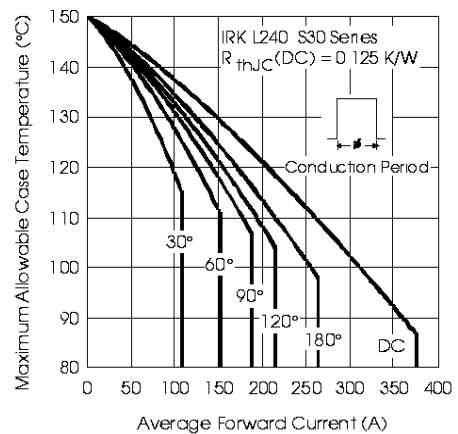

Fig. 8 - Current Ratings Characteristics

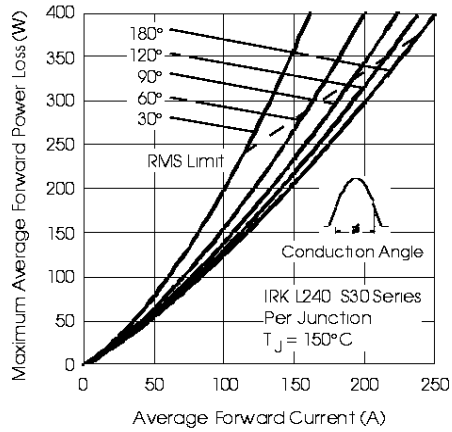

Fig. 9 - Forward Power Loss Characteristics

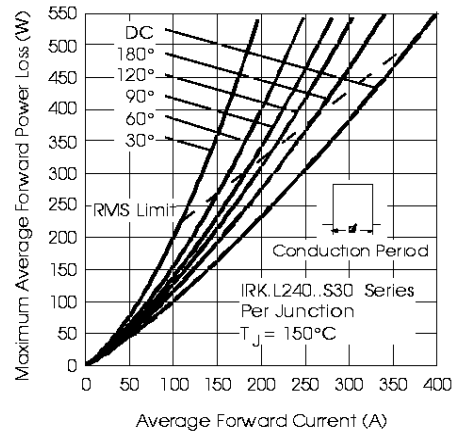

Fig. 10 - Forward Power Loss Characteristics

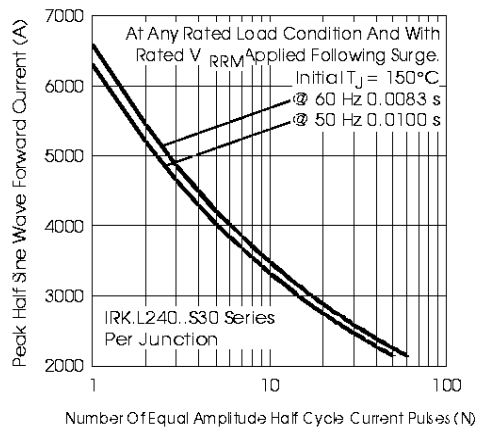

Fig. 11 - Maximum Non-Repetitive Surge Current

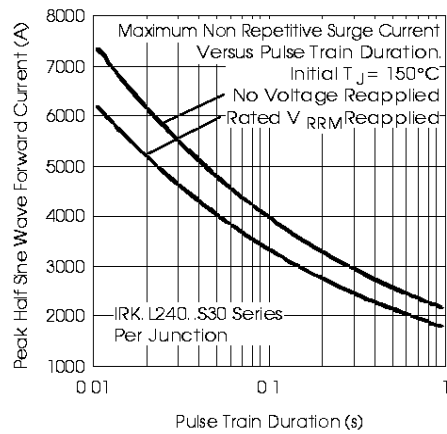

Fig. 12 - Maximum Non-Repetitive Surge Current

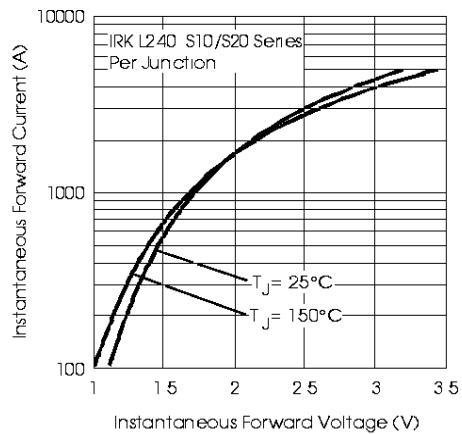

Fig. 13 - Forward Voltage Drop Characteristics

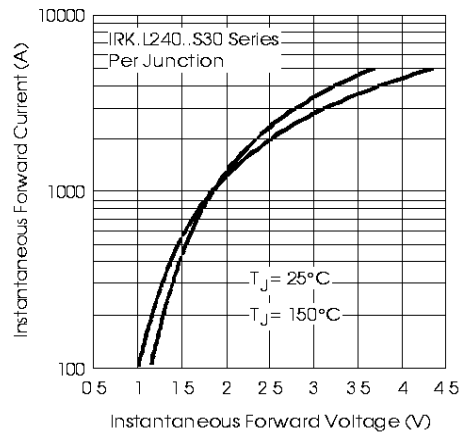

Fig. 14 - Forward Voltage Drop Characteristics

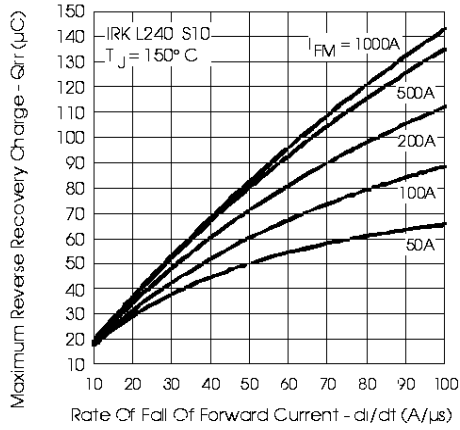

Fig. 15- Reverse Recovery Charge Characteristics

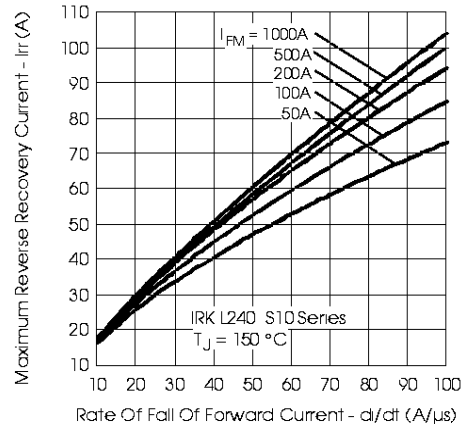

Fig. 16- Reverse Recovery Current Characteristics

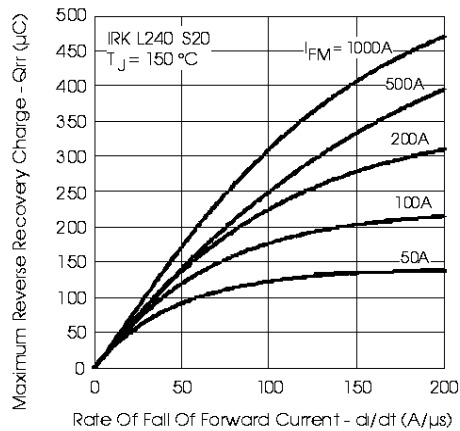

Fig. 17- Reverse Recovery Charge Characteristics

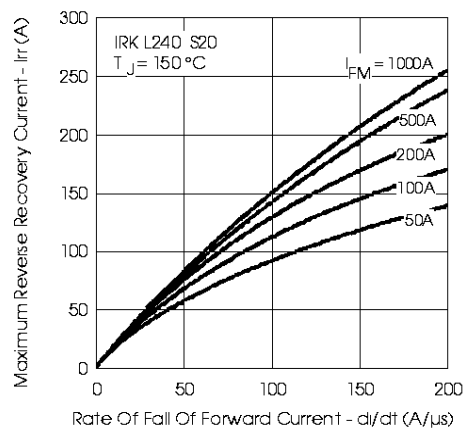

Fig. 18- Reverse Recovery Current Characteristics

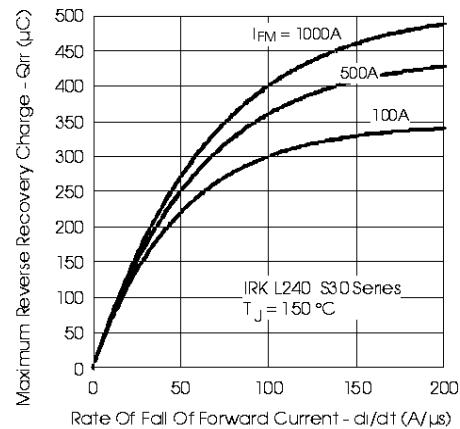

Fig. 19- Reverse Recovery Charge Characteristics

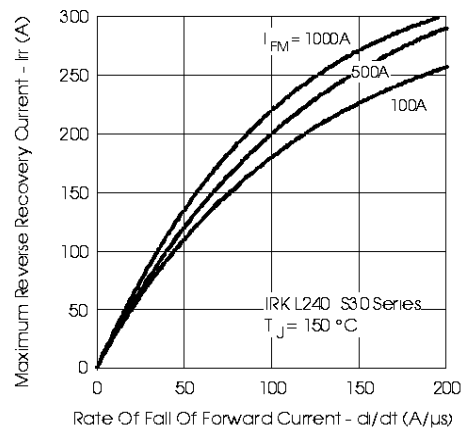

Fig. 20- Reverse Recovery Current Characteristics

**IRK.L240 Series**

Bulletin I27094 rev. A 09/97

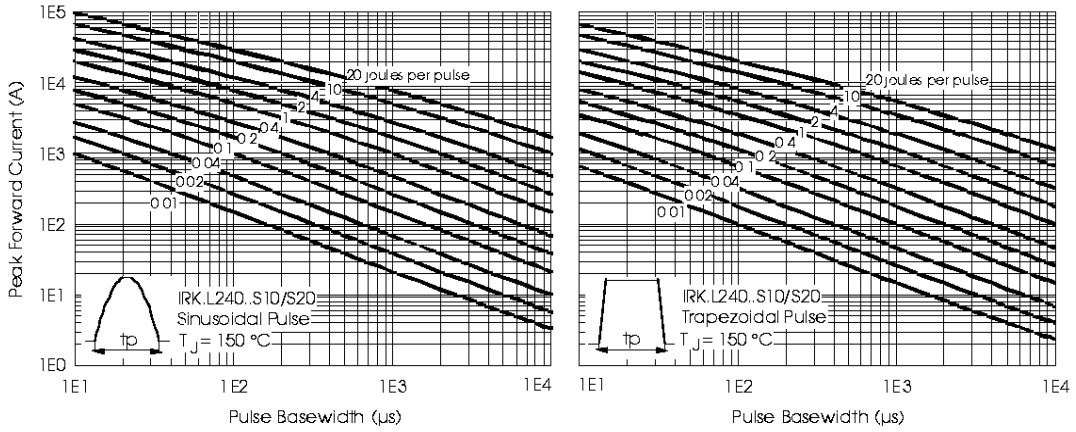

Fig.21 - Maximum Forward Energy Power Loss Characteristics

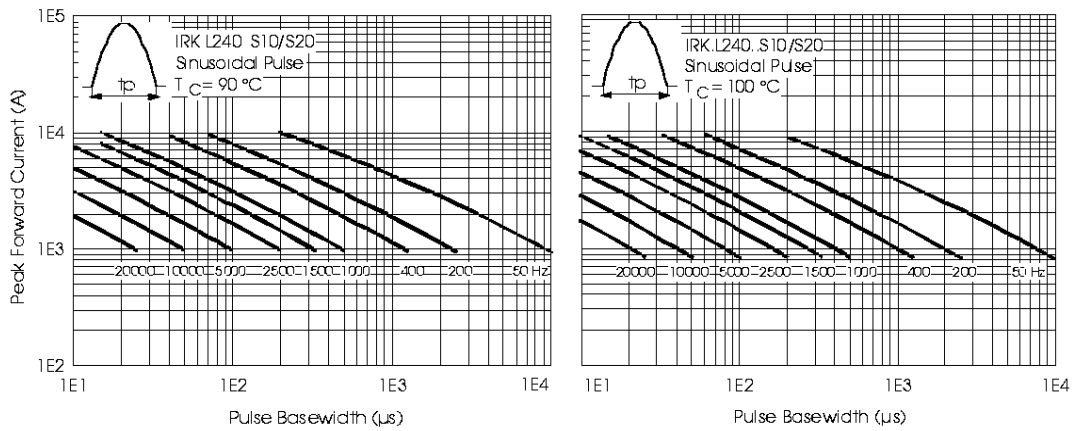

Fig. 22 - Frequency Characteristics

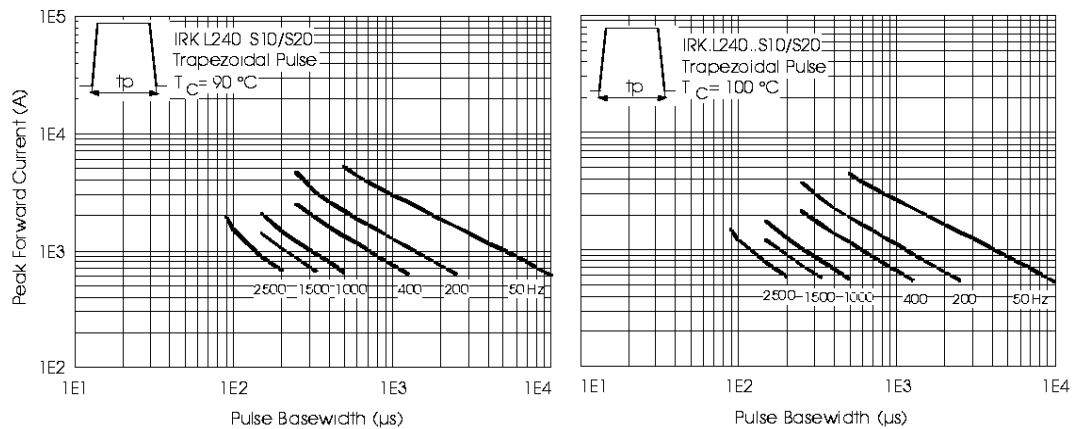

Fig. 23 - Frequency Characteristics



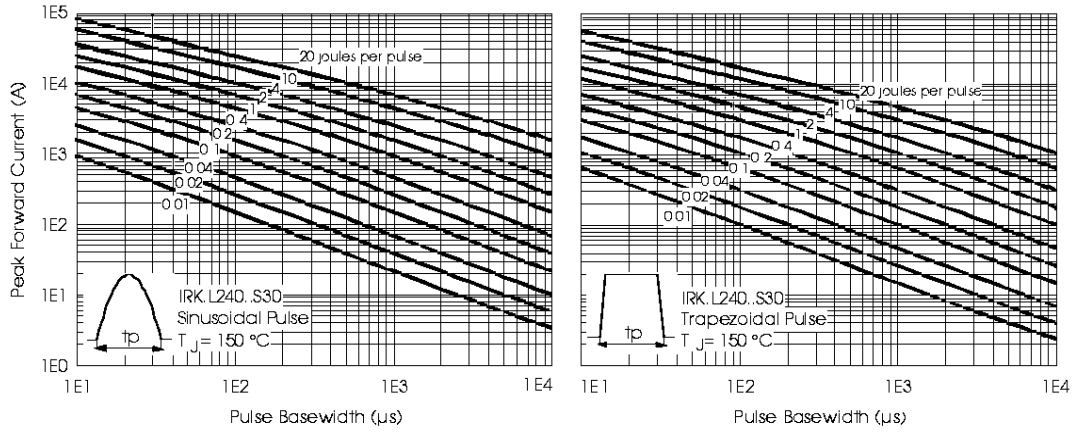

Fig. 24 - Maximum Forward Energy Power Loss Characteristics

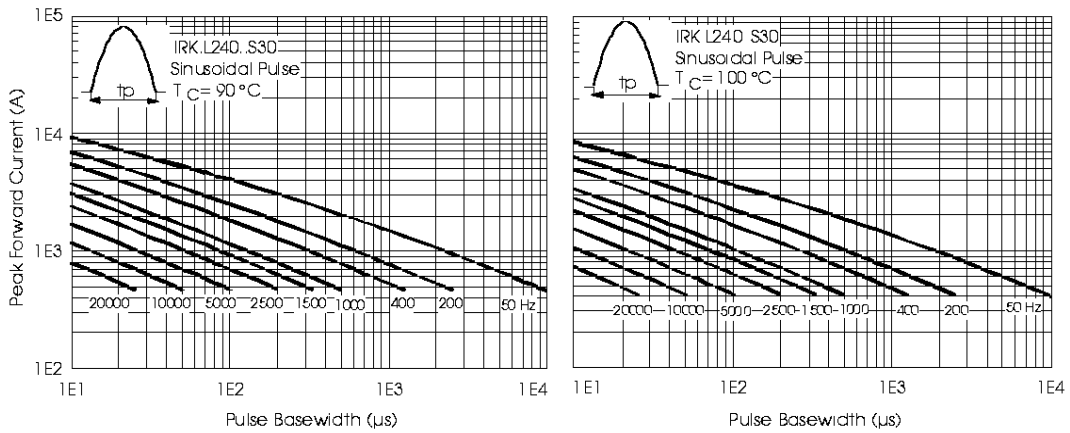

Fig.25-FrequencyCharacteristics

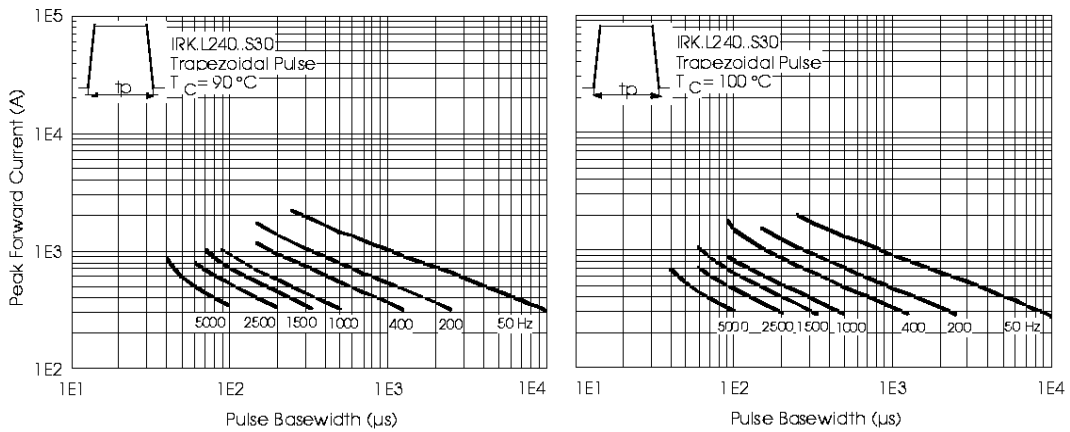

Fig.26-FrequencyCharacteristics

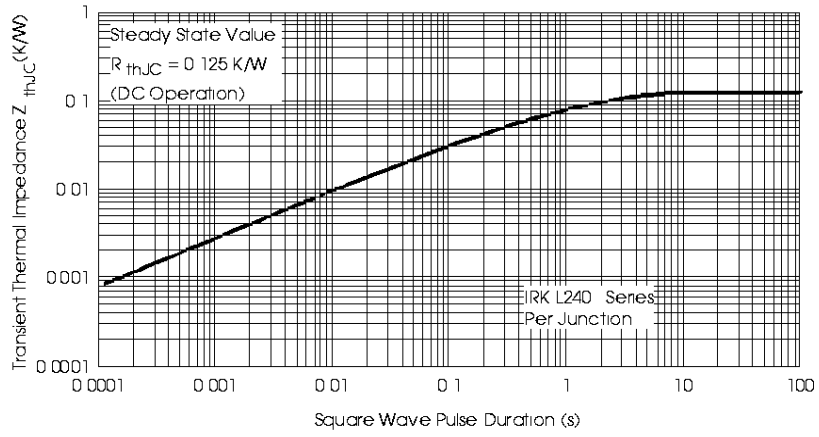

Fig. 27 - Thermal Impedance  $Z_{thJC}$  Characteristics