

## 300-mA 40-V LOW-DROPOUT REGULATOR WITH 25- $\mu$ A QUIESCENT CURRENT

 Check for Samples: [TPS7A6033-Q1](#), [TPS7A6050-Q1](#)

### FEATURES

- **Low Dropout Voltage**
  - 300mV at  $I_{OUT} = 150\text{mA}$
- **4-V to 40-V Wide Input Voltage Range With up to 45-V Transients**
- **300-mA Maximum Output Current**
- **Ultra Low Quiescent Current**
  - $I_{QUIESCENT} = 25\ \mu\text{A}$  (Typ) at Light Loads
  - $I_{SLEEP} < 2\ \mu\text{A}$  when EN = Low
- **3.3-V and 5-V Fixed Output Voltage**
- **Low-ESR Ceramic Output Stability Capacitor**
- **Integrated Power-On Reset**
  - Programmable Delay
  - Open-Drain Reset Output
- **Integrated Fault Protection**
  - Short-Circuit/Over-Current Protection
  - Thermal Shutdown
- **Low Input Voltage Tracking**
- **Thermally Enhanced Power Package**
  - 5-pin TO-263 (KTT /D2PAK)
  - 5-pin TO-252 (KVV /DPAK)

### APPLICATIONS

- **Qualified for Automotive Applications**
- **Infotainment Systems with Sleep Mode**
- **Body Control Modules**
- **Always ON Battery Applications**
  - Gateway Applications
  - Remote Keyless Entry Systems
  - Immobilizers

### DESCRIPTION

The TPS7A60xx/TPS7A61xx is a series of low dropout linear voltage regulators designed for low power consumption and quiescent current less than 25  $\mu\text{A}$  in light load applications. These devices feature an integrated over current protection and are designed to achieve stable operation even with low-ESR ceramic capacitors. Power-On Reset delay is implemented during device start up to indicate that the output voltage is stable and in regulation. The Power-On Reset delay is fixed (250  $\mu\text{s}$  typical), and can also be programmed by an external capacitor. Low voltage tracking feature allows for a smaller input capacitor and can possibly eliminate the need of using a boost converter during cold crank conditions. Because of these features, these devices are well suited in power supplies for various automotive applications.

### TYPICAL REGULATOR STABILITY

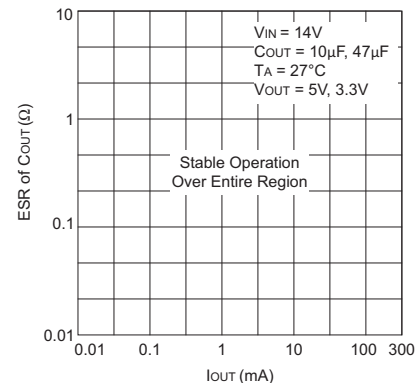

Figure 1. ESR vs Load Current for TPS7A60/1xx

### TYPICAL APPLICATION SCHEMATIC

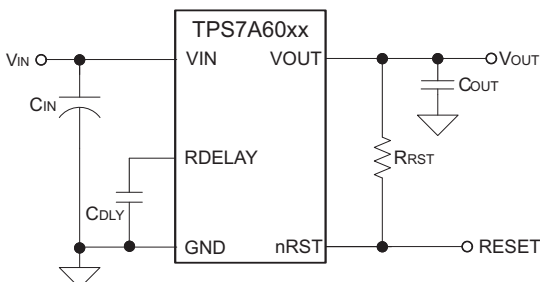

Figure 2. Programmable Reset Delay Option

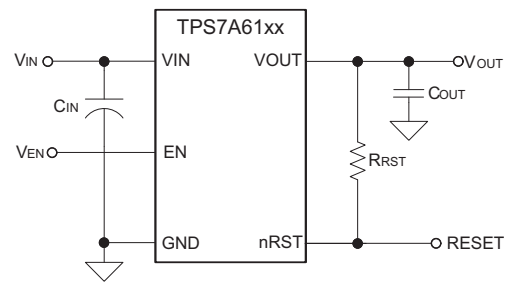

Figure 3. Enable Option



Please be aware that an important notice concerning availability, standard warranty, and use in critical applications of Texas Instruments semiconductor products and disclaimers thereto appears at the end of this data sheet.

### ORDERING INFORMATION<sup>(1)</sup>

KEY FEATURE	OUTPUT VOLTAGE	PACKAGE		ORDERABLE PART NUMBER <sup>(2)</sup>	TOP-SIDE MARKING
Programmable Reset Delay	5V	5 pin KTT	Reel of 500	TPS7A6050QKTTRQ1	7A6050Q1
		5 pin KVU	Tube of 70	TPS7A6050QKVUQ1	7A6050Q1
	3.3V		5 pin KTT	Reel of 500	TPS7A6033QKTTRQ1
		5 pin KVU	Reel of 2500	TPS7A6033QKVURQ1	7A6033Q1
Enable	5V	5 pin KTT	Reel of 500	TPS7A6150QKTTRQ1	Product Preview
		5 pin KVU	Reel of 2500	TPS7A6150QKVURQ1	Product Preview
	3.3V	5 pin KTT	Reel of 500	TPS7A6133QKTTRQ1	Product Preview
		5 pin KVU	Reel of 2500	TPS7A6133QKVURQ1	7A6133Q1

- (1) For the most current package and ordering information, see the Package Option Addendum at the end of this document, or see the TI web site at [www.ti.com](http://www.ti.com).  
(2) Package drawings, thermal data, and symbolization are available at [www.ti.com/packaging](http://www.ti.com/packaging).

### ABSOLUTE MAXIMUM RATINGS<sup>(1)</sup>

over operating free-air temperature range (unless otherwise noted)

NO.	DESCRIPTION		VALUE	UNIT
1.1	$V_{IN}, V_{EN}$	Unregulated inputs <sup>(2)(3)</sup>	45	V
1.2	$V_{OUT}$	Regulated output	7	V
1.3	nRST	Open drain reset output <sup>(2)</sup>	7	V
1.4	RDELAY	Output to charge an external capacitor <sup>(2)</sup>	7	V
1.5	$\theta_{JP}$	Thermal impedance junction to exposed pad KTT (D2PAK) package	10.4	°C/W
		Thermal impedance junction to exposed pad KVU (DPAK) package	12.7	°C/W
1.6	$\theta_{JA}$	Thermal impedance junction to ambient KTT (D2PAK) package <sup>(4)</sup>	30.2	°C/W
		Thermal impedance junction to ambient KVU (DPAK) package <sup>(4)</sup>	29.3	°C/W
1.7	$\theta_{JA}$	Thermal impedance junction to ambient KTT (D2PAK) package <sup>(5)</sup>	34.4	°C/W
		Thermal impedance junction to ambient KVU (DPAK) package <sup>(5)</sup>	38.6	°C/W
1.8	ESD	Electrostatic discharge <sup>(6)</sup>	2	kV
1.9	$T_{OP}$	Operating ambient temperature	125	°C
1.10	$T_S$	Storage temperature range	-65 to +150	°C

- (1) Stresses beyond those listed under *absolute maximum ratings* may cause permanent damage to the device. These are stress ratings only, and functional operation of the device at these or any other conditions beyond those indicated under *recommended operating conditions* is not implied. Exposure to absolute-maximum-rated conditions for extended periods may affect device reliability. All voltage values are with respect to GND.  
(2) Absolute negative voltage on these pins not to go below -0.3V.  
(3) Absolute maximum voltage for duration less than 480ms.  
(4) The thermal data is based on JEDEC standard high K profile – JESD 51-5. The copper pad is soldered to the thermal land pattern. Also correct attachment procedure needs to be incorporated.  
(5) The thermal data is based on JEDEC standard low K profile – JESD 51-3. The copper pad is soldered to the thermal land pattern. Also correct attachment procedure needs to be incorporated.  
(6) The human body model is a 100pF capacitor discharged through a 1.5kΩ resistor into each pin.

### DISSIPATION RATINGS

NO.	JEDEC STANDARD	PACKAGE	$T_A < 25^\circ\text{C}$ POWER RATING (W)	DERATING FACTOR ABOVE $T_A = 25^\circ\text{C}$ (°C/W)	$T_A = 85^\circ\text{C}$ POWER RATING (W)
2.1	JEDEC Standard PCB - low K, JESD 51-3	5 pin KTT	3.63	34.4	1.89
2.2		5 pin KVU	3.24	38.6	1.68
2.3	JEDEC Standard PCB - high K, JESD 51-5	5 pin KTT	4.14	30.2	2.15
2.4		5 pin KVU	4.27	29.3	2.22

## RECOMMENDED OPERATING CONDITIONS

NO.	DESCRIPTION	MIN	MAX	UNIT
3.1	$V_{IN}$ , $V_{EN}^{(1)}$ Unregulated input voltage	4	40	V
3.2	nRST, RDELAY <sup>(2)</sup> Low voltage input/output	0	5.25	V
3.3	$T_J$ Operating junction temperature range	-40	150	°C

(1) Applicable for TPS7A61xx only.

(2) Applicable for TPS7A60xx only.

## ELECTRICAL CHARACTERISTICS

$V_{IN} = 14V$ ,  $T_J = -40^{\circ}C$  to  $150^{\circ}C$  (unless otherwise noted)

NO.	PARAMETER	TEST CONDITIONS	MIN	TYP	MAX	UNIT
<b>4. Input Voltage (VIN pin)</b>						
4.1	$V_{IN}$ Input voltage	Fixed 5V output, $I_{OUT} = 1mA$	5.3		40	V
		Fixed 3.3V output, $I_{OUT} = 1mA$	4		40	
4.2	$I_{QUIESCENT}$ Quiescent current	$V_{IN} = 8.2V$ to $18V$ , $V_{EN}^{(1)} = 5V$ , $I_{OUT} = 0.01mA$ to $0.75mA$		25	40	$\mu A$
4.3	$I_{SLEEP}^{(1)}$ Sleep/shutdown current	$V_{IN} = 8.2V$ to $18V$ , $V_{EN}^{(1)} < 0.8V$ , $I_{OUT} = 0mA$ (no load), $T_A = 125^{\circ}C$			3	$\mu A$
4.4	$V_{IN-UVLO}$ Under voltage lock out voltage	Ramp $V_{IN}$ down until output is turned OFF		3.16		V
4.5	$V_{IN(POWERUP)}$ Power up voltage	Ramp $V_{IN}$ up until output is turned ON		3.45		V
<b>5. Enable Input (EN pin)</b>						
5.1	$V_{IL}^{(1)}$ Logic input low level		0		0.8	V
5.2	$V_{IH}^{(1)}$ Logic input high level		2.5		40	V
<b>6. Regulated Output Voltage (VOUT pin)</b>						
6.1	$V_{OUT}$ Regulated output voltage	Fixed $V_{OUT}$ value (3.3V or 5V as applicable), $I_{OUT} = 10mA$	-2		2	%
6.2	$\Delta V_{LINE-REG}$ Line regulation	$V_{IN} = 6V$ to $28V$ , $I_{OUT} = 10mA$ , $V_{OUT} = 5V$			15	mV
		$V_{IN} = 6V$ to $28V$ , $I_{OUT} = 10mA$ , $V_{OUT} = 3.3V$			20	mV
6.3	$\Delta V_{LOAD-REG}$ Load regulation	$I_{OUT} = 10mA$ to $300mA$ , $V_{IN} = 14V$ , $V_{OUT} = 5V$			25	mV
		$I_{OUT} = 10mA$ to $300mA$ , $V_{IN} = 14V$ , $V_{OUT} = 3.3V$			35	mV
6.4	$V_{DROPOUT}^{(2)}$ Dropout voltage ( $V_{IN} - V_{OUT}$ )	$I_{OUT} = 250mA$			500	mV
		$I_{OUT} = 150mA$			300	mV
6.5	$R_{SW}^{(3)}$ Switch resistance	$V_{IN}$ to $V_{OUT}$ resistance			2	$\Omega$
6.6	$I_{OUT}$ Output current	$V_{OUT}$ in regulation	0		300	mA
6.7	$I_{CL}$ Output current limit	$V_{OUT} = 0V$ ( $V_{OUT}$ pin is shorted to ground)	350		1000	mA
6.8	PSRR <sup>(3)</sup> Power supply ripple rejection	$V_{IN-RIPPLE} = 0.5 V_{pp}$ , $I_{OUT} = 300mA$ , frequency = 100 Hz, $V_{OUT} = 5V$ and $V_{OUT} = 3.3V$		60		dB
		$V_{IN-RIPPLE} = 0.5 V_{pp}$ , $I_{OUT} = 300mA$ , frequency = 150 kHz, $V_{OUT} = 5V$ and $V_{OUT} = 3.3V$		30		

(1) Applicable for TPS7A61xx only.

(2) This test is done with  $V_{OUT}$  in regulation and  $V_{IN} - V_{OUT}$  parameter is measured when  $V_{OUT}$  (3.3V or 5.0V) drops by 100mV at specified loads.

(3) Specified by design – not tested

## ELECTRICAL CHARACTERISTICS (continued)

$V_{IN} = 14V$ ,  $T_J = -40^{\circ}C$  to  $150^{\circ}C$  (unless otherwise noted)

NO.	PARAMETER	TEST CONDITIONS	MIN	TYP	MAX	UNIT
<b>7. Reset (nRST pin)</b>						
7.1	$V_{OL}$ Reset pulled low	$I_{OL} = 5mA$			0.4	V
7.2	$I_{OH}$ Leakage current	Reset pulled to VOUT through 5k $\Omega$ resistor			1	$\mu A$
7.3	$V_{TH(POR)}$ Power-On Reset threshold	$V_{OUT}$ power up above internally set tolerance, $V_{OUT} = 5V$	4.5	4.65	4.77	V
		$V_{OUT}$ power up above internally set tolerance, $V_{OUT} = 3.3V$		3.07		
7.4	$UV_{THRES}$ Reset threshold	$V_{OUT}$ falling below internally set tolerance, $V_{OUT} = 5V$	4.5	4.65	4.77	V
		$V_{OUT}$ falling below internally set tolerance, $V_{OUT} = 3.3V$		3.07		
7.5	$t_{POR}^{(4)}$ Power-On Reset delay	$C_{DLY} = 100pF$		300		$\mu s$
		$C_{DLY} = 100nF$		300		ms
7.6	$t_{POR-PRESET}$ Internally preset Power-On Reset delay	$C_{DLY}$ not connected in TPS7A60xx/ not available in TPS7A61xx, $V_{OUT} = 5V$ and $V_{OUT} = 3.3V$		250		$\mu s$
7.7	$t_{DEGLITCH}$ Reset deglitch time			5.5		$\mu s$
<b>8. Reset Delay (RDELAY pin)</b>						
8.1	$V_{TH(RDELAY)}^{(5)}$ Threshold to release nRST high	Voltage at RDELAY pin is ramped up		3	3.3	V
8.2	$I_{DLY}^{(5)}$ Delay capacitor charging current		0.75	1	1.25	$\mu A$
8.3	$I_{OL}^{(5)}$ Delay capacitor discharging current	Voltage at RDELAY pin = 1V	5			mA
<b>9. Operating Temperature Range</b>						
9.1	$T_J$ Operating junction temperature		-40		150	$^{\circ}C$
9.2	$T_{SHUTDOWN}$ Thermal shutdown trip point			165		$^{\circ}C$
9.3	$T_{HYST}$ Thermal shutdown hysteresis			10		$^{\circ}C$

(4) Design Information – not tested; specified by characterization

(5) Applicable for TPS7A60xx only.

## DEVICE INFORMATION

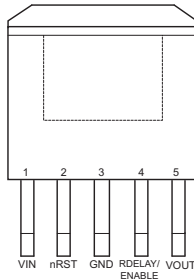
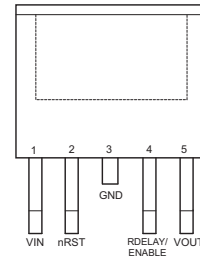
**KTT PACKAGE  
(TOP VIEW)**

**KVU PACKAGE  
(TOP VIEW)**

## TERMINAL FUNCTIONS

NO.	NAME	TYPE	DESCRIPTION
1	VIN	I	Input voltage pin: The unregulated input voltage is supplied to this pin. A bypass capacitor is connected between VIN pin and GND pin to dampen input line transients.
2	nRST	O	Reset pin: This is an output pin with an external pull up resistor connected to VOUT pin.
3	GND	I/O	Ground pin: This is signal ground pin of the IC.
4	RDELAY	O	Reset delay timer pin (for TPS7A60xx only): This pin is used to program the reset delay timer using an external capacitor ( $C_{DLY}$ ) to ground.
	EN	I	Enable pin (for TPS7A61xx only): This is a high voltage tolerant input pin with an internal pull down. A high input to this pin activates the device and turns the regulator ON. This input can be connected to VIN terminal for self bias applications. If this pin is not connected, the device will stay disabled.
5	VOUT	O	Regulated output voltage pin: This is a regulated voltage output ( $V_{OUT} = 3.3V$ or $5V$ , as applicable) pin with a limitation on maximum output current. In order to achieve stable operation and prevent oscillation, an external output capacitor ( $C_{OUT}$ ) with low ESR is connected between this pin and GND pin.

FUNCTIONAL BLOCK DIAGRAM

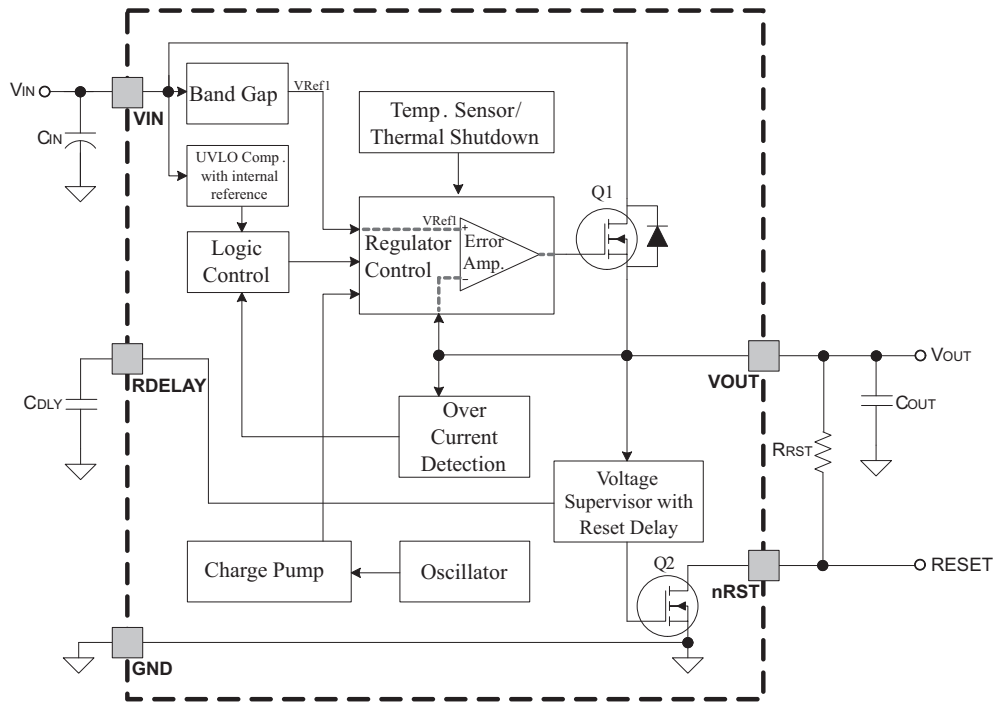

Figure 4. TPS7A60xx Functional Block Diagram

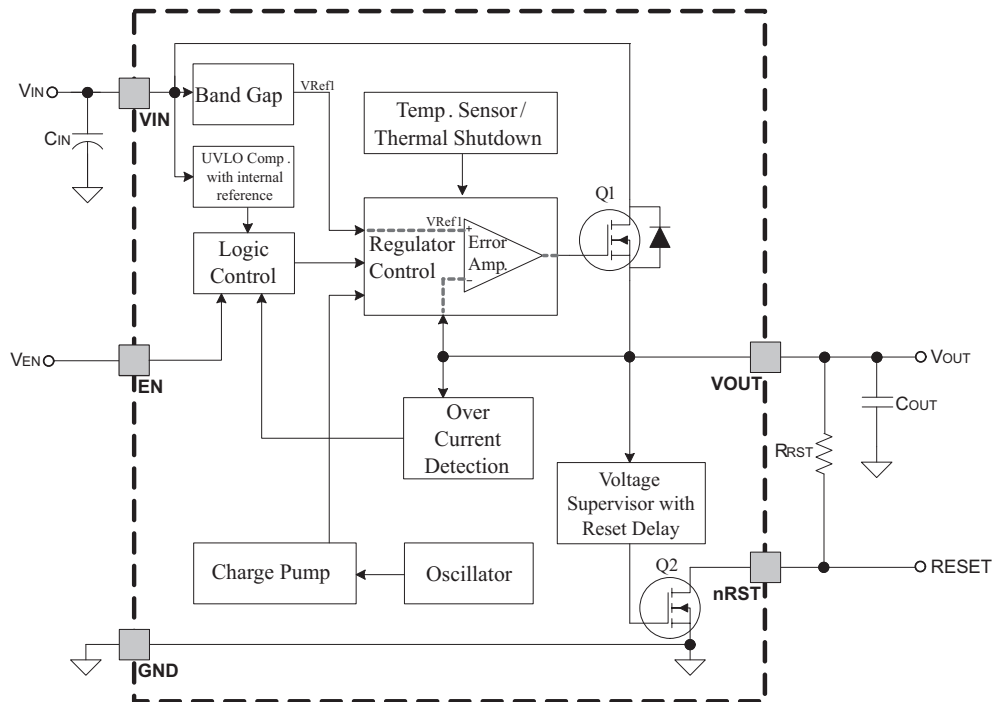
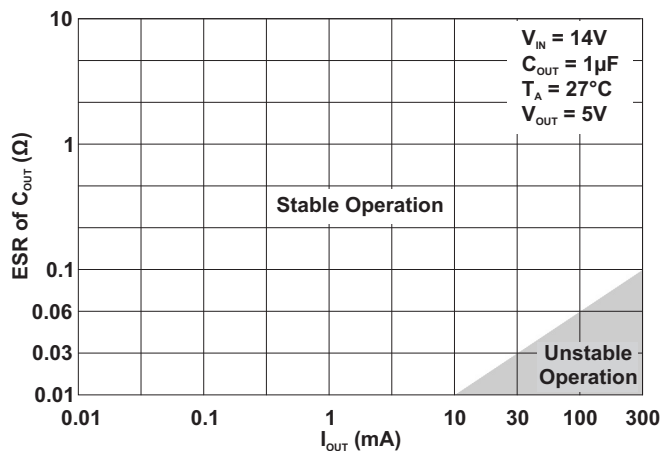

Figure 5. TPS7A61xx Functional Block Diagram

TYPICAL CHARACTERISTICS

ESR  
vs  
LOAD CURRENT



ESR  
vs  
LOAD CURRENT

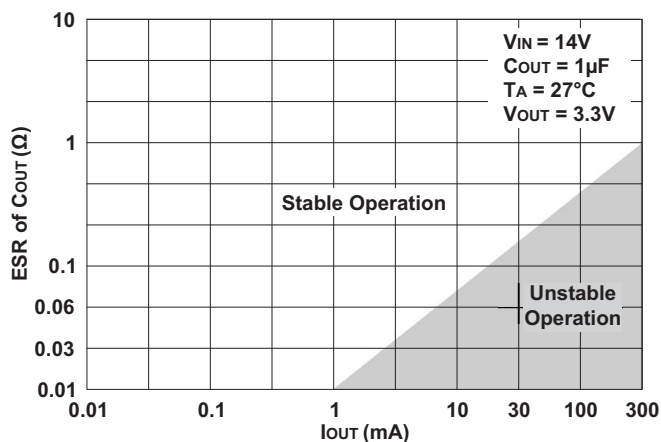

QUIESCENT CURRENT  
vs  
LOAD CURRENT

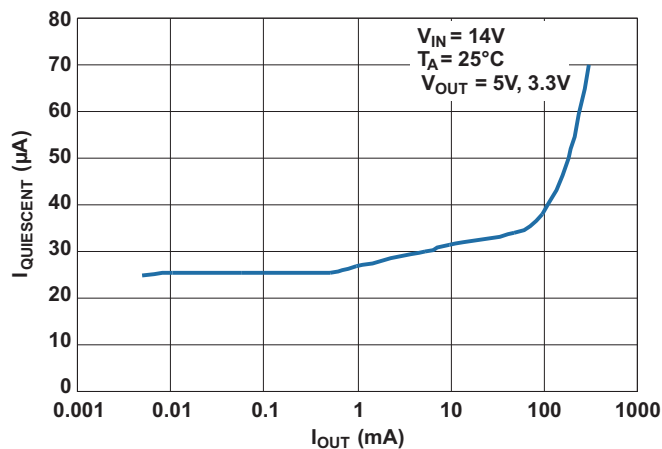

QUIESCENT CURRENT  
vs  
AMBIENT AIR TEMPERATURE

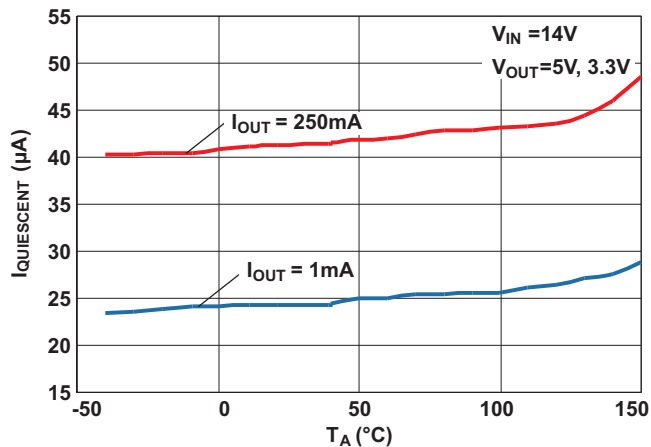

**TYPICAL CHARACTERISTICS (continued)**

**QUIESCENT CURRENT  
vs  
INPUT VOLTAGE**

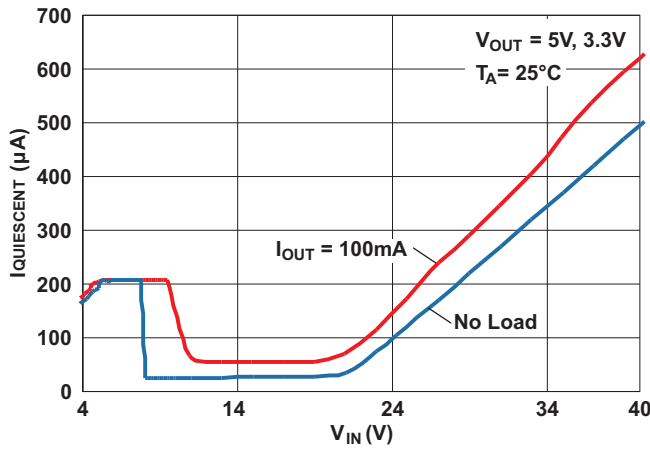

**DROP OUT VOLTAGE<sup>(1)</sup>  
vs  
LOAD CURRENT**

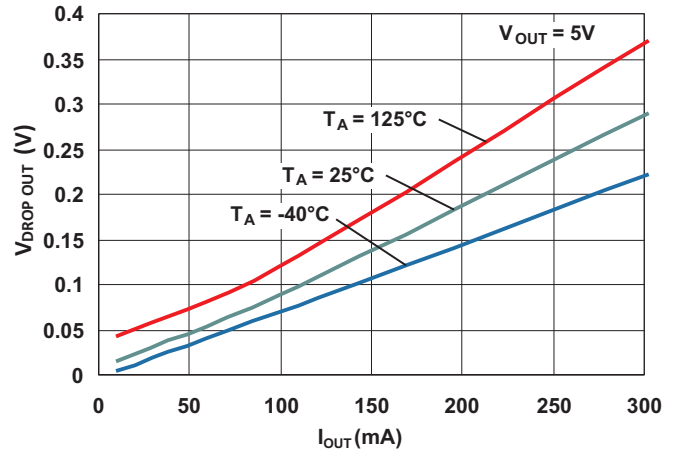

**OUTPUT VOLTAGE  
vs  
AMBIENT AIR TEMPERATURE**

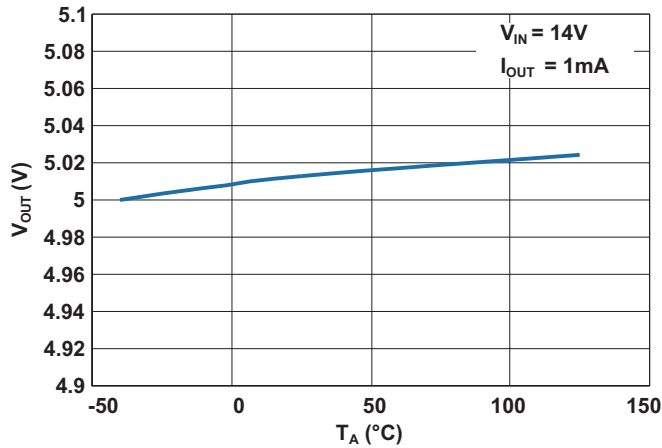

**OUTPUT VOLTAGE  
vs  
INPUT VOLTAGE**

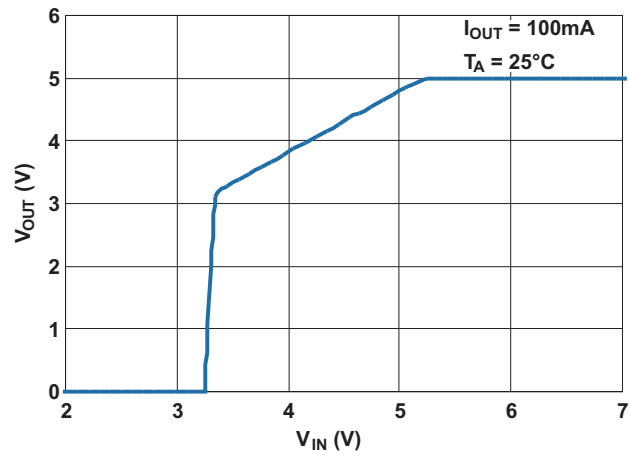

(1) Drop out voltage is measured when the output voltage drops by 100mV from the regulated output voltage level. (For example, drop out voltage for TPS7A6050 is measured when the output voltage drops down to 4.9V from 5V.)



TYPICAL CHARACTERISTICS (continued)

OUTPUT CURRENT  
vs  
INPUT VOLTAGE

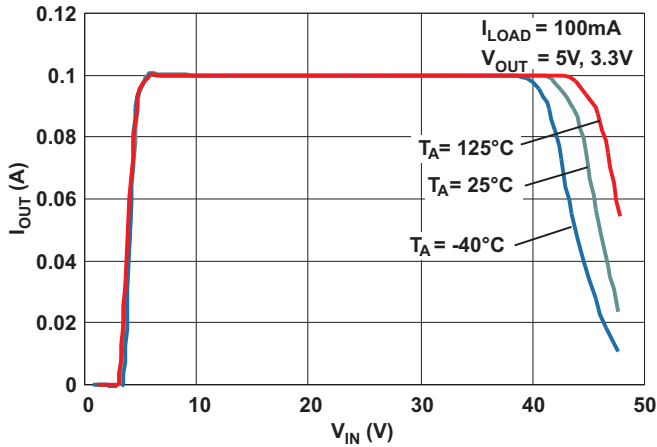

OUTPUT CURRENT LIMIT  
vs  
AMBIENT AIR TEMPERATURE

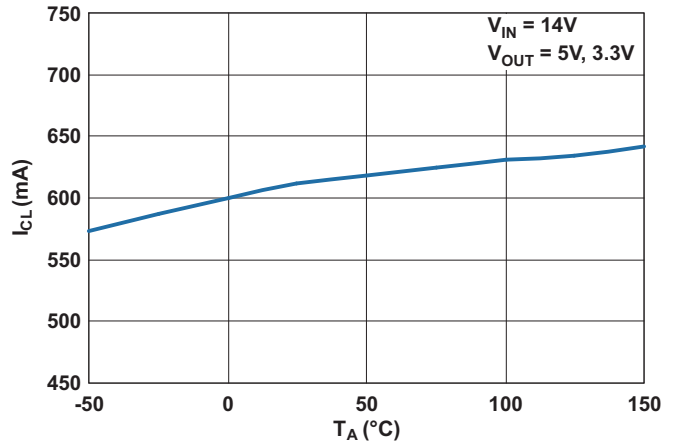

LOAD REGULATION  
vs  
AMBIENT AIR TEMPERATURE

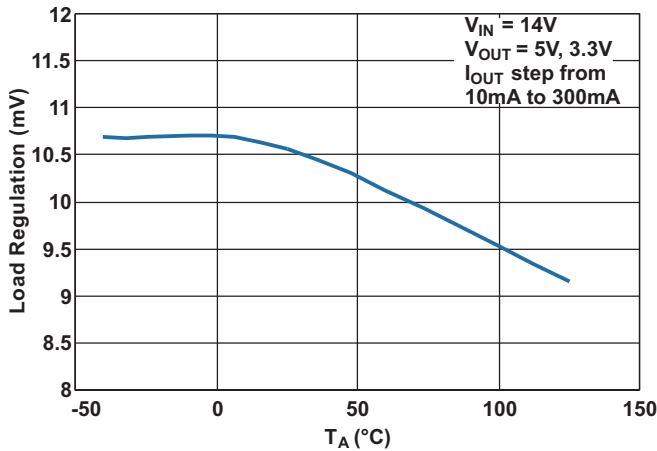

LINE REGULATION  
vs  
AMBIENT AIR TEMPERATURE

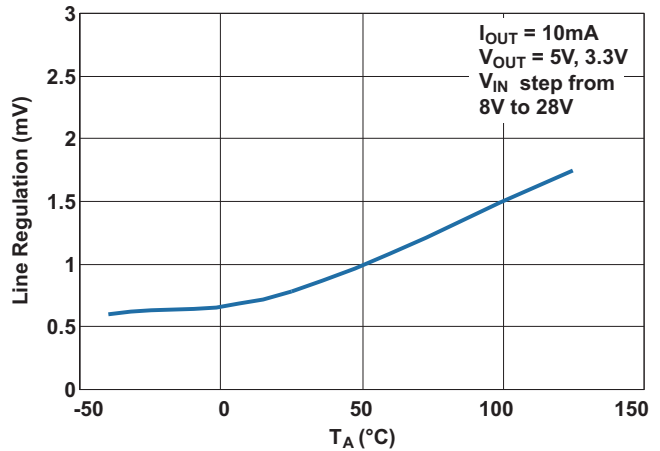

PSRR AT HEAVY LOAD CURRENT

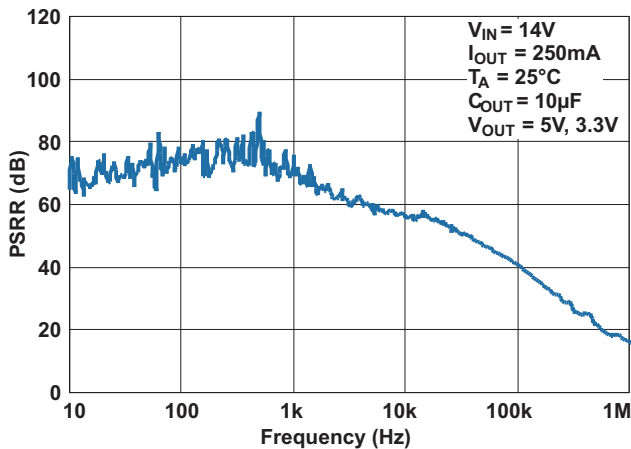

PSRR AT LIGHT LOAD CURRENT

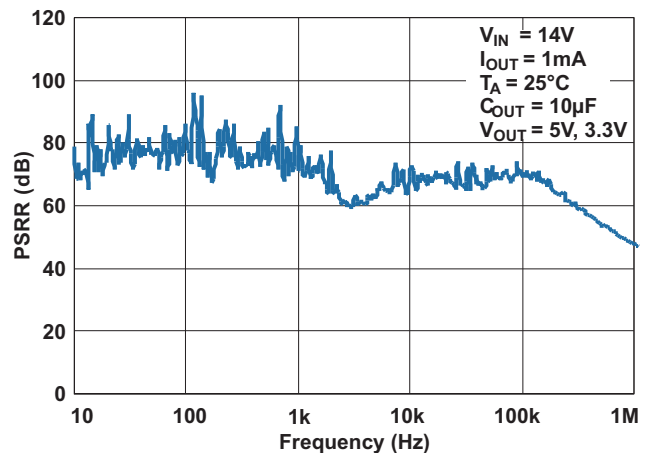

Note: Graphs shown in 'Typical Characteristics' section for unreleased devices are for preview only.

## DETAILED DESCRIPTION

TPS7A60/1xx is a series of monolithic low dropout linear voltage regulators with integrated reset functionality. These voltage regulators are designed for low power consumption and quiescent current less than 25µA in light load applications. Because of an integrated reset delay (also called Power-On Reset delay), these devices are well suited in power supplies for microprocessors/ microcontrollers.

These devices are available in two fixed output voltage (3.3V and 5V) versions as follows:

- Programmable reset delay version (TPS7A60xx)
- Enable version (TPS7A61xx)

The following section describes the features of TPS7A60/1xx voltage regulators in detail.

### Reset Delay and Reset Output

Reset delay is implemented when the device starts up to indicate that output voltage is stable and in regulation, and also when the output recovers from a negative voltage spike due to a load step or a dip in the input voltage for a specified duration. Reset delay timer is initialized when the voltage at output ( $V_{OUT}$ ) exceeds 93% of the regulated output voltage (3.3V or 5V, as applicable). The reset output ( $nRST$ ) is asserted high after Power-On Reset delay ( $t_{POR}$ ) has elapsed. If the regulated output voltage falls below 93% of the set level,  $nRST$  is asserted low after a short de-glitch time of approximately 5.5µs (typical).

For TPS7A60xx devices, reset delay time can be programmed by connecting an external capacitor ( $C_{DLY}$ ) to RDELAY pin. The delay time is given by Equation 1:

$$t_{POR} = \frac{C_{DLY} \times 3}{1 \times 10^{-6}} \quad (1)$$

Where,

$t_{POR}$  = reset delay time in seconds

$C_{DLY}$  = reset delay capacitor value in farads, 100 pF to 100 nF

In TPS7A61xx devices, there is no RDELAY pin and reset delay time is preset internally (250µs typical).

During power up, the regulator incorporates a protection scheme to limit the current through pass element and output capacitor. When the input voltage exceeds a certain threshold ( $V_{IN(POWERUP)}$ ) level, the output voltage begins to ramp as shown in Figure 6 and Figure 7. When the output voltage reaches power on reset threshold ( $V_{TH(POR)}$ ) level, a constant output current charges an external capacitor ( $C_{DLY}$ ) to an internal threshold ( $V_{TH(RDELAY)}$ ) voltage level. Then,

$nRST$  is asserted high and  $C_{DLY}$  is discharged through an internal load. This allows  $C_{DLY}$  to charge from approximately 0V during the next power cycle. If no external capacitor is connected, the delay time is preset internally. This is shown in Figure 6.

In TPS7A60xx devices, if  $C_{DLY}$  capacitor is not connected to RDELAY pin, reset delay time is set internally. This is shown in Figure 7.

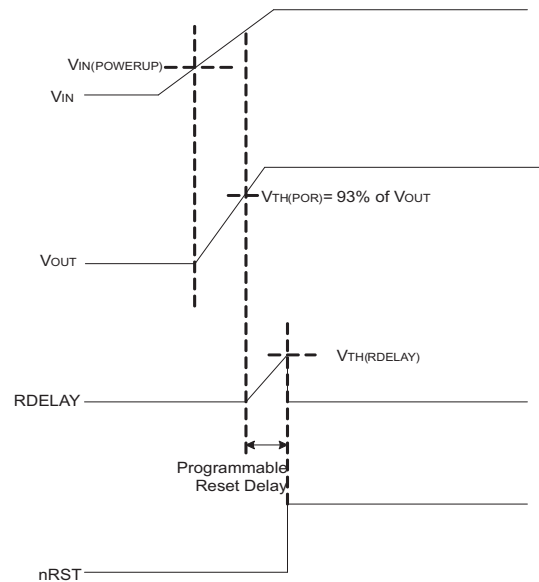

**Figure 6. Power Up and Reset Delay Function with  $C_{DLY}$  Capacitor connected to RDELAY Pin for TPS7A60xx**

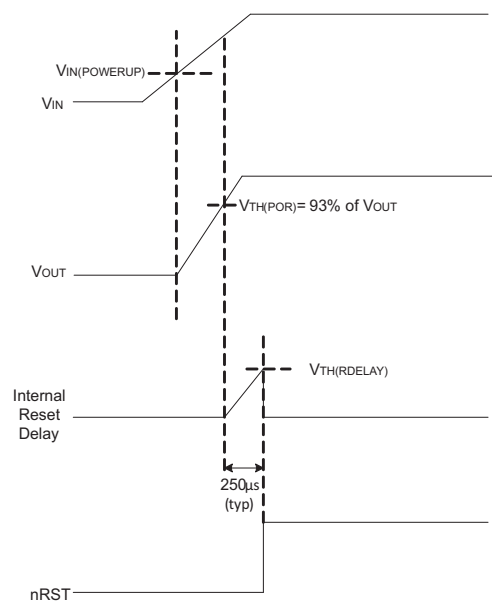

**Figure 7. Power Up and Reset Delay Function with  $C_{DLY}$  Capacitor not connected/available in TPS7A60xx/TPS7A61xx respectively**

In case of negative transients in the input voltage ( $V_{IN}$ ), the reset signal will be asserted low only if the output ( $V_{OUT}$ ) drops and stays below the reset threshold level ( $V_{TH(POR)}$ ) for more than deglitch time ( $t_{DEGLITCH}$ ). This is shown in Figure 8.

sequence will be followed.  $nRST$  will be asserted high, only if the output voltage exceeds the reset threshold voltage ( $V_{TH(POR)}$ ) and the reset delay time ( $t_{POR}$ ) has elapsed. This is shown in the shaded region of Figure 8.

While  $nRST$  is low, if the input voltage resumes to the nominal operating voltage, normal power up

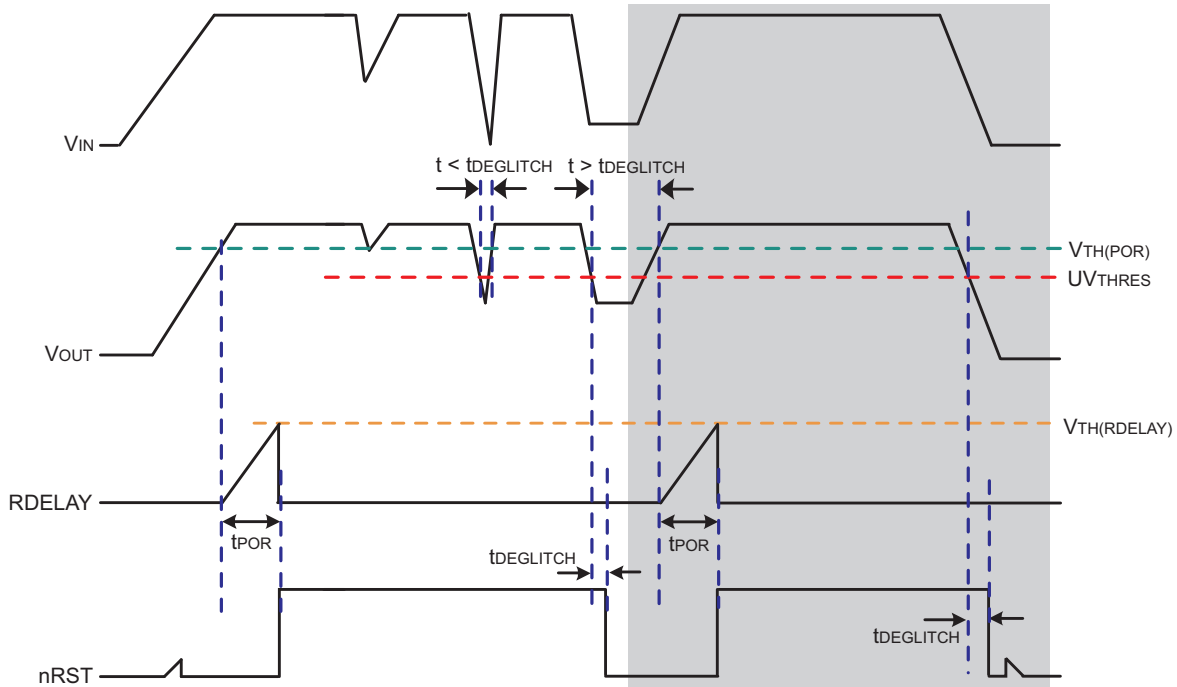

Figure 8. Conditions for Activation of Reset

### Charge Pump Operation

These devices have an internal charge pump which turns on or off depending on the input voltage and the output current. The charge pump switching circuitry shall not cause conducted emissions to exceed required thresholds on the input voltage line. For a given output current, the charge pump stays on at

lower input voltages and turns off at higher input voltages. The charge pump switching thresholds are hysteretic. Figure 9 and Figure 10 shows typical switching thresholds for the charge pump at light ( $I_{OUT} < \sim 2mA$ ) and heavy ( $I_{OUT} > \sim 2mA$ ) loads respectively.

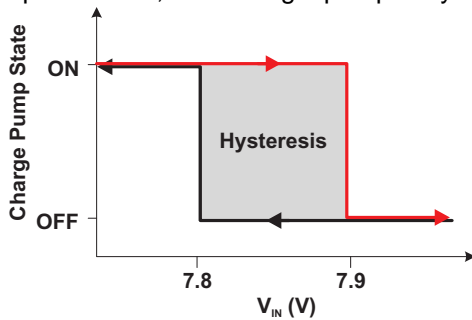

Figure 9. Charge Pump Operation at Light Loads

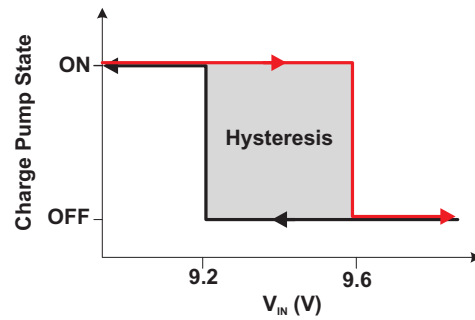

Figure 10. Charge Pump Operation at Heavy Loads

## Low Power Mode

At light loads and high input voltages ( $V_{IN} > \sim 8V$  such that charge pump is off) the device operates in Low Power Mode and the quiescent current consumption is reduced to  $25\mu A$  (typical) as shown in Table 1.

**Table 1. Typical Quiescent Current Consumption**

$I_{OUT}$	Charge Pump ON	Charge Pump OFF
$I_{OUT} < \sim 2mA$ (Light load)	$250\mu A$	$25\mu A$ (Low Power Mode)
$I_{OUT} > \sim 2mA$ (Heavy load)	$280\mu A$	$70\mu A$

## Under Voltage Shutdown

These devices have an integrated under voltage lock out (UVLO) circuit to shutdown the output if the input voltage ( $V_{IN}$ ) falls below an internally fixed UVLO threshold level ( $V_{IN-UVLO}$ ). This ensures that the regulator is not latched into an unknown state during low input voltage conditions. The regulator will power up when the input voltage exceeds  $V_{IN(POWERUP)}$  level.

## Low Voltage Tracking

At low input voltages the regulator drops out of regulation, the output voltage tracks input minus a voltage based on the load current ( $I_{OUT}$ ) and switch resistance ( $R_{SW}$ ). This allows for a smaller input capacitor and can possibly eliminate the need of using a boost convertor during cold crank conditions.

## Integrated Fault Protection

These devices feature an integrated fault protection to make them ideal for use in automotive applications. In order to keep them in safe area of operation during certain fault conditions, internal current limit protection and current limit fold back are used to limit the maximum output current. This

protects them from excessive power dissipation. For example, during a short circuit condition on the output; current through the pass element is limited to  $I_{CL}$  to protect the device from excessive power dissipation.

## Thermal Shutdown

These devices incorporate a thermal shutdown (TSD) circuit as a protection from overheating. For continuous normal operation, the junction temperature should not exceed TSD trip point. If the junction temperature exceeds TSD trip point, the output is turned off. When the junction temperature falls below TSD trip point, the output is turned on again. This is shown in Figure 11.

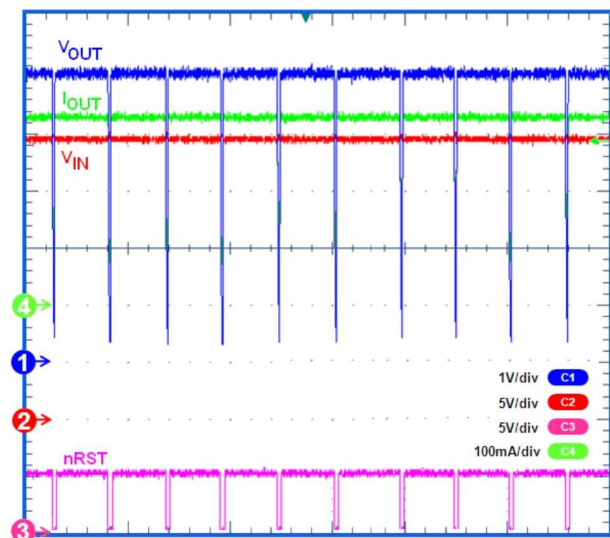

**Figure 11. Thermal Cycling Waveform for TPS7A6050 ( $V_{IN} = 24V$ ,  $I_{OUT} = 300mA$ ,  $V_{OUT} = 5V$ )**

## APPLICATION INFORMATION

Typical application circuits for TPS7A60xx and TPS7A61xx are shown in Figure 12 and Figure 13 respectively. Depending upon an end application, different values of external components may be used. A larger output capacitor may be required during fast load steps in order to prevent reset from occurring. A low ESR ceramic capacitor with dielectric of type X5R or X7R is recommended. Additionally, a bypass capacitor can be connected at the output to decouple high frequency noise as per the end application.

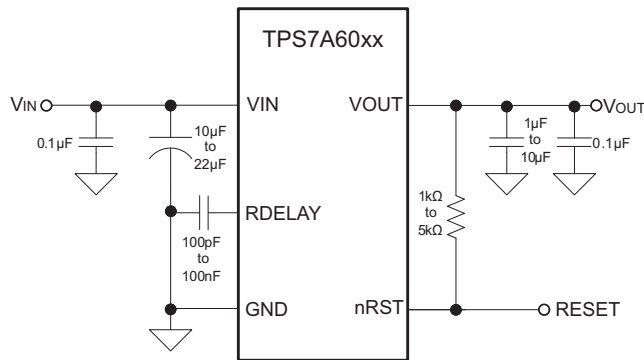

Figure 12. Typical Application Schematic for TPS7A60xx

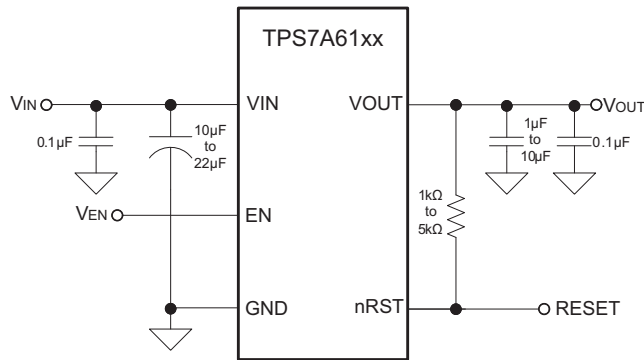

Figure 13. Typical Application Schematic for TPS7A61xx

### Power Dissipation and Thermal Considerations

Power dissipated in the device can be calculated using Equation 2.

$$P_D = I_{OUT} \times (V_{IN} - V_{OUT}) + I_{QUIESCENT} \times V_{IN} \quad (2)$$

Where,

$P_D$  = continuous power dissipation

$I_{OUT}$  = output current

$V_{IN}$  = input voltage

$V_{OUT}$  = output voltage

$I_{QUIESCENT}$  = quiescent current

As  $I_{QUIESCENT} \ll I_{OUT}$ , therefore, the term  $I_{QUIESCENT} \times V_{IN}$  in Equation 2 can be ignored.

For device under operation at a given ambient air temperature ( $T_A$ ), the junction temperature ( $T_J$ ) can be calculated using Equation 3.

$$T_J = T_A + (\theta_{JA} \times P_D) \quad (3)$$

Where,

$\theta_{JA}$  = junction to ambient air thermal impedance

The rise in junction temperature due to power dissipation can be calculated using Equation 4.

$$\Delta T = T_J - T_A = (\theta_{JA} \times P_D) \quad (4)$$

For a given maximum junction temperature ( $T_{J-Max}$ ), the maximum ambient air temperature ( $T_{A-Max}$ ) at which the device can operate can be calculated using Equation 5.

$$T_{A-Max} = T_{J-Max} - (\theta_{JA} \times P_D) \quad (5)$$

### Example

If  $I_{OUT} = 100\text{mA}$ ,  $V_{OUT} = 5\text{V}$ ,  $V_{IN} = 14\text{V}$ ,  $I_{QUIESCENT} = 250\mu\text{A}$  and  $\theta_{JA} = 30^\circ\text{C/W}$ , the continuous power dissipated in the device is 0.9W. The rise in junction temperature due to power dissipation is  $27^\circ\text{C}$ . For a maximum junction temperature of  $150^\circ\text{C}$ , maximum ambient air temperature at which the device can operate is  $123^\circ\text{C}$ .

For adequate heat dissipation, it is recommended to solder the power pad (exposed heat sink) to thermal land pad on the PCB. Doing this provides a heat conduction path from die to the PCB and reduces overall package thermal resistance. Power derating curves for TPS7A60/1xx series of devices in KTT(D2PAK) and KVU(DPAK) packages are shown in Figure 14.

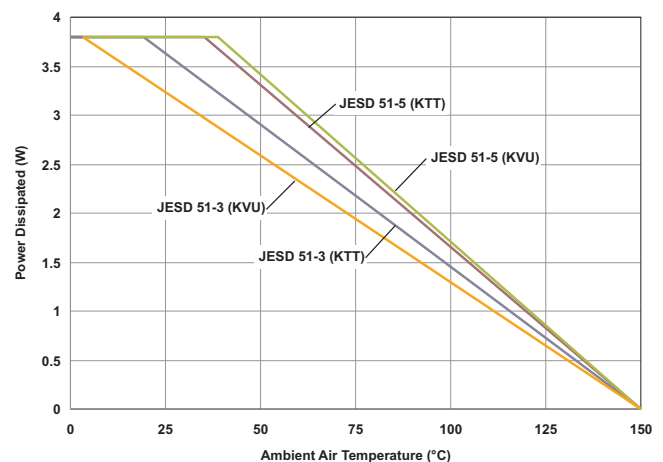
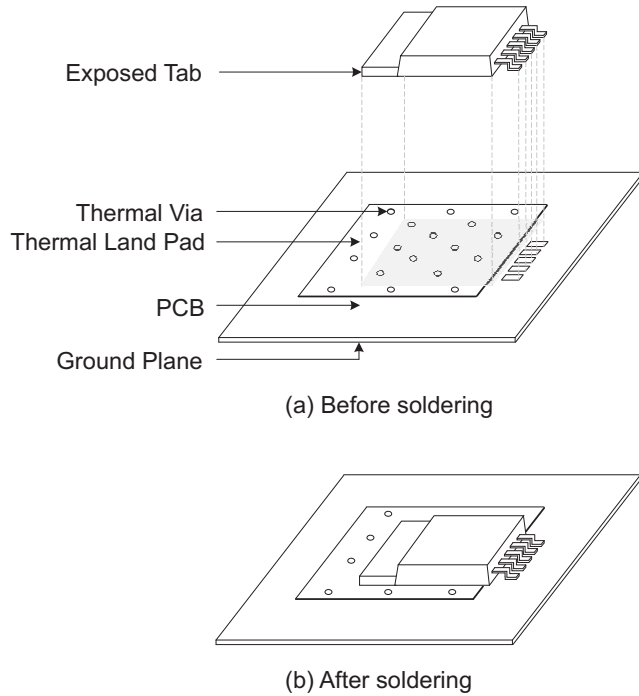

Figure 14. Power Derating Curves

For optimum thermal performance, it is recommended

to use a high K PCB with thermal vias between ground plane and solder pad/ thermal land pad. This is shown in Figure 15 (a) and (b). Further, heat spreading capabilities of a PCB can be considerably improved by using a thicker ground plane and a thermal land pad with a larger surface area.



**Figure 15. Using Multilayer PCB and Thermal Vias For Adequate Heat Dissipation**

Keeping other factors constant, surface area of the thermal land pad contributes to heat dissipation only to a certain extent. Figure 16 shows variation of  $\theta_{JA}$  with surface area of the thermal land pad (soldered to the exposed pad) for KTT and KVU packages.

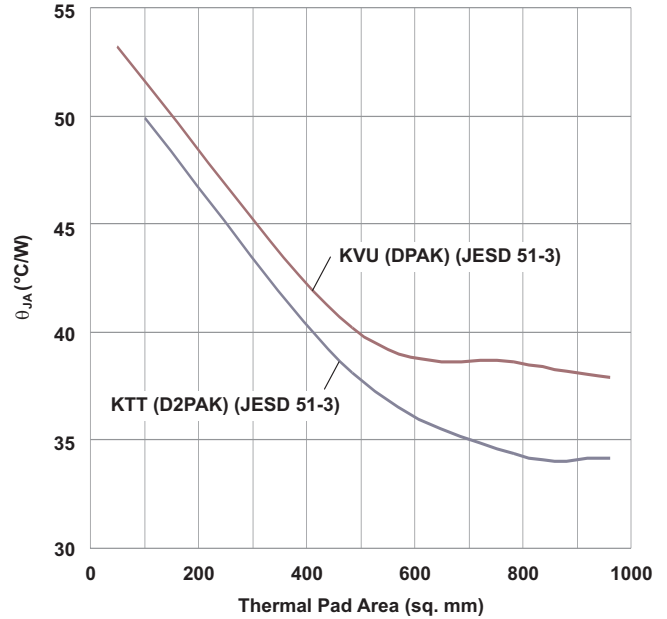

**Figure 16.  $\theta_{JA}$  vs Thermal Pad Area**

**PACKAGING INFORMATION**

Orderable Device	Status <sup>(1)</sup>	Package Type	Package Drawing	Pins	Package Qty	Eco Plan <sup>(2)</sup>	Lead/ Ball Finish	MSL Peak Temp <sup>(3)</sup>	Samples (Requires Login)
TPS7A6033QKTRRQ1	ACTIVE	DDPAK/ TO-263	KTT	5	500	Green (RoHS & no Sb/Br)	CU SN	Level-3-245C-168 HR	
TPS7A6033QKVURQ1	ACTIVE	PFM	KVU	5	2500	Green (RoHS & no Sb/Br)	CU SN	Level-3-260C-168 HR	
TPS7A6050QKTRRQ1	ACTIVE	DDPAK/ TO-263	KTT	5	500	Green (RoHS & no Sb/Br)	CU SN	Level-3-245C-168 HR	
TPS7A6050QKVURQ1	ACTIVE	PFM	KVU	5	2500	Green (RoHS & no Sb/Br)	CU SN	Level-3-260C-168 HR	
TPS7A6133QKVURQ1	ACTIVE	PFM	KVU	5	2500	Green (RoHS & no Sb/Br)	CU SN	Level-3-260C-168 HR	
TPS7A6150QKVURQ1	PREVIEW	PFM	KVU	5	2500	TBD	Call TI	Call TI	

<sup>(1)</sup> The marketing status values are defined as follows:

**ACTIVE:** Product device recommended for new designs.

**LIFEBUY:** TI has announced that the device will be discontinued, and a lifetime-buy period is in effect.

**NRND:** Not recommended for new designs. Device is in production to support existing customers, but TI does not recommend using this part in a new design.

**PREVIEW:** Device has been announced but is not in production. Samples may or may not be available.

**OBSOLETE:** TI has discontinued the production of the device.

<sup>(2)</sup> Eco Plan - The planned eco-friendly classification: Pb-Free (RoHS), Pb-Free (RoHS Exempt), or Green (RoHS & no Sb/Br) - please check <http://www.ti.com/productcontent> for the latest availability information and additional product content details.

**TBD:** The Pb-Free/Green conversion plan has not been defined.

**Pb-Free (RoHS):** TI's terms "Lead-Free" or "Pb-Free" mean semiconductor products that are compatible with the current RoHS requirements for all 6 substances, including the requirement that lead not exceed 0.1% by weight in homogeneous materials. Where designed to be soldered at high temperatures, TI Pb-Free products are suitable for use in specified lead-free processes.

**Pb-Free (RoHS Exempt):** This component has a RoHS exemption for either 1) lead-based flip-chip solder bumps used between the die and package, or 2) lead-based die adhesive used between the die and leadframe. The component is otherwise considered Pb-Free (RoHS compatible) as defined above.

**Green (RoHS & no Sb/Br):** TI defines "Green" to mean Pb-Free (RoHS compatible), and free of Bromine (Br) and Antimony (Sb) based flame retardants (Br or Sb do not exceed 0.1% by weight in homogeneous material)

<sup>(3)</sup> MSL, Peak Temp. -- The Moisture Sensitivity Level rating according to the JEDEC industry standard classifications, and peak solder temperature.

**Important Information and Disclaimer:** The information provided on this page represents TI's knowledge and belief as of the date that it is provided. TI bases its knowledge and belief on information provided by third parties, and makes no representation or warranty as to the accuracy of such information. Efforts are underway to better integrate information from third parties. TI has taken and continues to take reasonable steps to provide representative and accurate information but may not have conducted destructive testing or chemical analysis on incoming materials and chemicals. TI and TI suppliers consider certain information to be proprietary, and thus CAS numbers and other limited information may not be available for release.

In no event shall TI's liability arising out of such information exceed the total purchase price of the TI part(s) at issue in this document sold by TI to Customer on an annual basis.



**TAPE AND REEL INFORMATION**

**QUADRANT ASSIGNMENTS FOR PIN 1 ORIENTATION IN TAPE**

\*All dimensions are nominal

Device	Package Type	Package Drawing	Pins	SPQ	Reel Diameter (mm)	Reel Width W1 (mm)	A0 (mm)	B0 (mm)	K0 (mm)	P1 (mm)	W (mm)	Pin1 Quadrant
TPS7A6033QKTTRQ1	DDPAK/ TO-263	KTT	5	500	330.0	24.4	10.6	15.8	4.9	16.0	24.0	Q2
TPS7A6033QKVURQ1	PFM	KVU	5	2500	330.0	16.4	6.9	10.5	2.7	8.0	16.0	Q2
TPS7A6050QKTTRQ1	DDPAK/ TO-263	KTT	5	500	330.0	24.4	10.6	15.8	4.9	16.0	24.0	Q2
TPS7A6050QKVURQ1	PFM	KVU	5	2500	330.0	16.4	6.9	10.5	2.7	8.0	16.0	Q2
TPS7A6133QKVURQ1	PFM	KVU	5	2500	330.0	16.4	6.9	10.5	2.7	8.0	16.0	Q2

**TAPE AND REEL BOX DIMENSIONS**



\*All dimensions are nominal

Device	Package Type	Package Drawing	Pins	SPQ	Length (mm)	Width (mm)	Height (mm)
TPS7A6033QKTTRQ1	DDPAK/TO-263	KTT	5	500	340.0	340.0	38.0
TPS7A6033QKVURQ1	PFM	KVU	5	2500	340.0	340.0	38.0
TPS7A6050QKTTRQ1	DDPAK/TO-263	KTT	5	500	340.0	340.0	38.0
TPS7A6050QKVURQ1	PFM	KVU	5	2500	340.0	340.0	38.0
TPS7A6133QKVURQ1	PFM	KVU	5	2500	340.0	340.0	38.0

# MECHANICAL DATA

KTT (R-PSFM-G5)

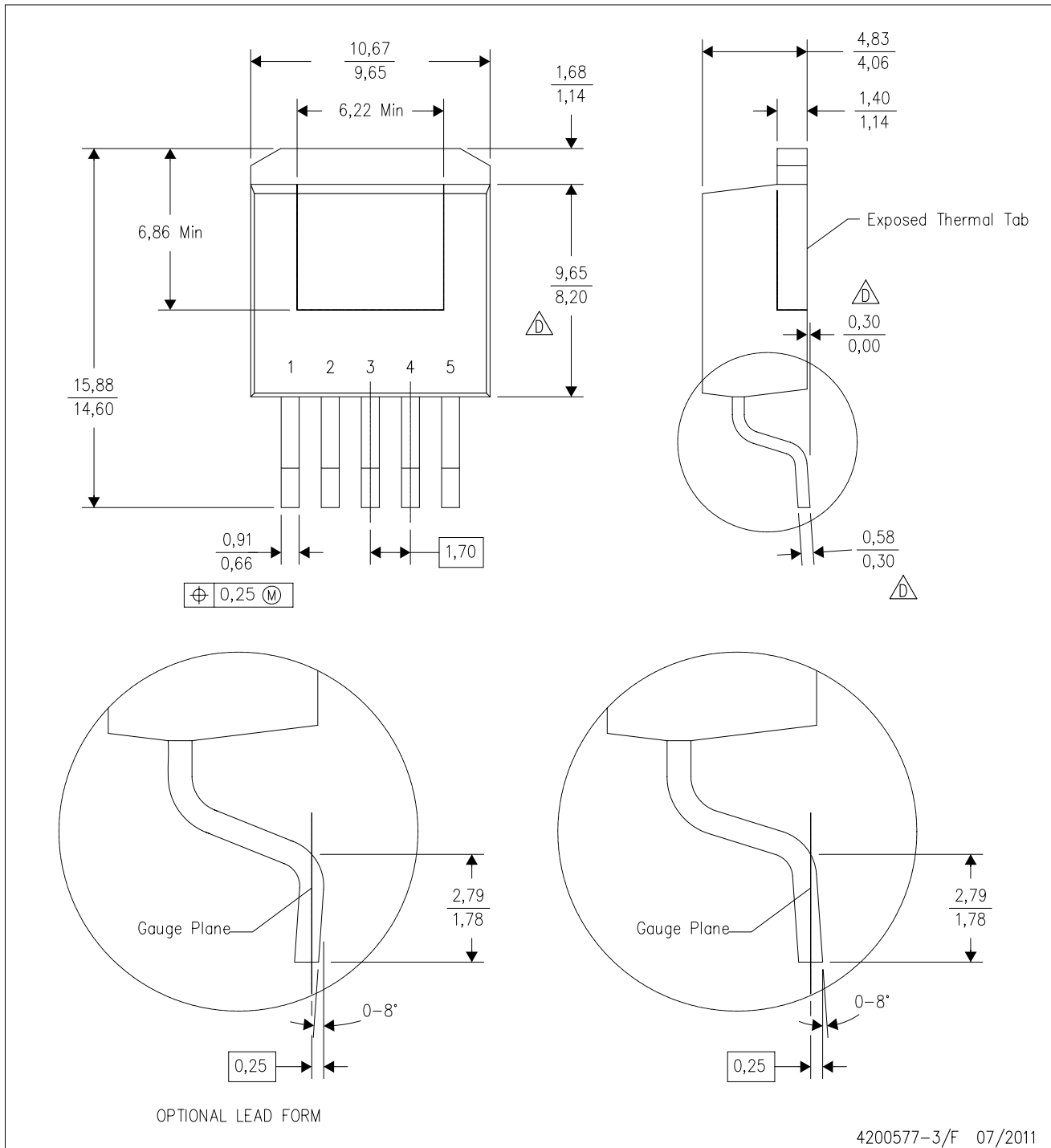
PLASTIC FLANGE-MOUNT PACKAGE



4200577-3/F 07/2011

- NOTES:
- All linear dimensions are in millimeters.
  - This drawing is subject to change without notice.
  - Body dimensions do not include mold flash or protrusion. Mold flash or protrusion not to exceed 0.005 (0,13) per side.
- Falls within JEDEC TO-263 variation BA, except minimum lead thickness, maximum seating height, and minimum body length.

# MECHANICAL DATA

KVU (R-PSFM-G5)

PLASTIC FLANGE-MOUNT PACKAGE

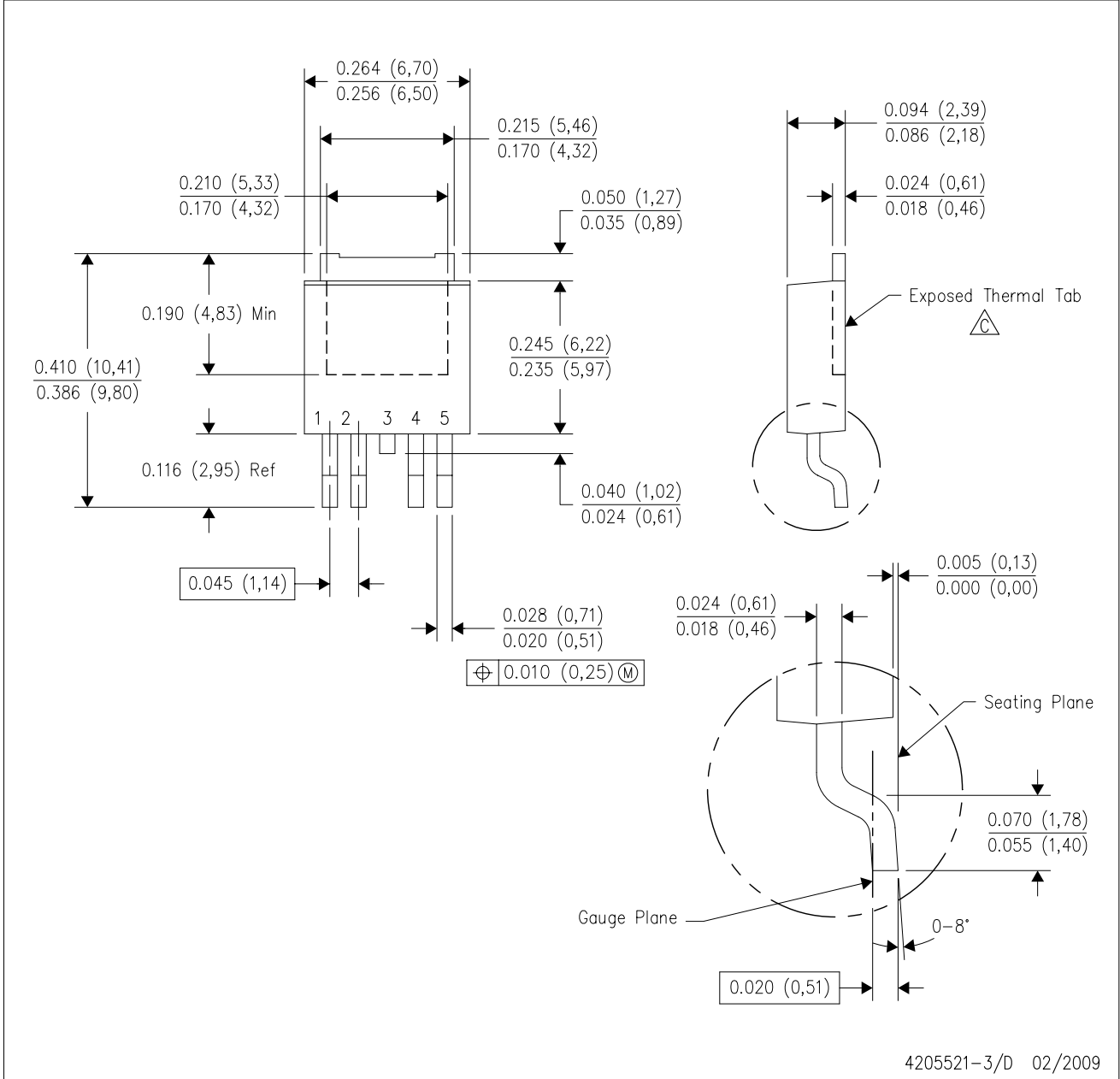

- NOTES:
- A. All linear dimensions are in inches (millimeters).
  - B. This drawing is subject to change without notice.
  - C. The center lead is in electrical contact with the exposed thermal tab.
  - D. Body Dimensions do not include mold flash or protrusions. Mold flash and protrusion shall not exceed 0.006 (0,15) per side.
  - E. Falls within JEDEC TO-252 variation AD.

## IMPORTANT NOTICE

Texas Instruments Incorporated and its subsidiaries (TI) reserve the right to make corrections, modifications, enhancements, improvements, and other changes to its products and services at any time and to discontinue any product or service without notice. Customers should obtain the latest relevant information before placing orders and should verify that such information is current and complete. All products are sold subject to TI's terms and conditions of sale supplied at the time of order acknowledgment.

TI warrants performance of its hardware products to the specifications applicable at the time of sale in accordance with TI's standard warranty. Testing and other quality control techniques are used to the extent TI deems necessary to support this warranty. Except where mandated by government requirements, testing of all parameters of each product is not necessarily performed.

TI assumes no liability for applications assistance or customer product design. Customers are responsible for their products and applications using TI components. To minimize the risks associated with customer products and applications, customers should provide adequate design and operating safeguards.

TI does not warrant or represent that any license, either express or implied, is granted under any TI patent right, copyright, mask work right, or other TI intellectual property right relating to any combination, machine, or process in which TI products or services are used. Information published by TI regarding third-party products or services does not constitute a license from TI to use such products or services or a warranty or endorsement thereof. Use of such information may require a license from a third party under the patents or other intellectual property of the third party, or a license from TI under the patents or other intellectual property of TI.

Reproduction of TI information in TI data books or data sheets is permissible only if reproduction is without alteration and is accompanied by all associated warranties, conditions, limitations, and notices. Reproduction of this information with alteration is an unfair and deceptive business practice. TI is not responsible or liable for such altered documentation. Information of third parties may be subject to additional restrictions.

Resale of TI products or services with statements different from or beyond the parameters stated by TI for that product or service voids all express and any implied warranties for the associated TI product or service and is an unfair and deceptive business practice. TI is not responsible or liable for any such statements.

TI products are not authorized for use in safety-critical applications (such as life support) where a failure of the TI product would reasonably be expected to cause severe personal injury or death, unless officers of the parties have executed an agreement specifically governing such use. Buyers represent that they have all necessary expertise in the safety and regulatory ramifications of their applications, and acknowledge and agree that they are solely responsible for all legal, regulatory and safety-related requirements concerning their products and any use of TI products in such safety-critical applications, notwithstanding any applications-related information or support that may be provided by TI. Further, Buyers must fully indemnify TI and its representatives against any damages arising out of the use of TI products in such safety-critical applications.

TI products are neither designed nor intended for use in military/aerospace applications or environments unless the TI products are specifically designated by TI as military-grade or "enhanced plastic." Only products designated by TI as military-grade meet military specifications. Buyers acknowledge and agree that any such use of TI products which TI has not designated as military-grade is solely at the Buyer's risk, and that they are solely responsible for compliance with all legal and regulatory requirements in connection with such use.

TI products are neither designed nor intended for use in automotive applications or environments unless the specific TI products are designated by TI as compliant with ISO/TS 16949 requirements. Buyers acknowledge and agree that, if they use any non-designated products in automotive applications, TI will not be responsible for any failure to meet such requirements.

Following are URLs where you can obtain information on other Texas Instruments products and application solutions:

### Products

Audio	<a href="http://www.ti.com/audio">www.ti.com/audio</a>
Amplifiers	<a href="http://amplifier.ti.com">amplifier.ti.com</a>
Data Converters	<a href="http://dataconverter.ti.com">dataconverter.ti.com</a>
DLP® Products	<a href="http://www.dlp.com">www.dlp.com</a>
DSP	<a href="http://dsp.ti.com">dsp.ti.com</a>
Clocks and Timers	<a href="http://www.ti.com/clocks">www.ti.com/clocks</a>
Interface	<a href="http://interface.ti.com">interface.ti.com</a>
Logic	<a href="http://logic.ti.com">logic.ti.com</a>
Power Mgmt	<a href="http://power.ti.com">power.ti.com</a>
Microcontrollers	<a href="http://microcontroller.ti.com">microcontroller.ti.com</a>
RFID	<a href="http://www.ti-rfid.com">www.ti-rfid.com</a>
RF/IF and ZigBee® Solutions	<a href="http://www.ti.com/lprf">www.ti.com/lprf</a>

### Applications

Communications and Telecom	<a href="http://www.ti.com/communications">www.ti.com/communications</a>
Computers and Peripherals	<a href="http://www.ti.com/computers">www.ti.com/computers</a>
Consumer Electronics	<a href="http://www.ti.com/consumer-apps">www.ti.com/consumer-apps</a>
Energy and Lighting	<a href="http://www.ti.com/energy">www.ti.com/energy</a>
Industrial	<a href="http://www.ti.com/industrial">www.ti.com/industrial</a>
Medical	<a href="http://www.ti.com/medical">www.ti.com/medical</a>
Security	<a href="http://www.ti.com/security">www.ti.com/security</a>
Space, Avionics and Defense	<a href="http://www.ti.com/space-avionics-defense">www.ti.com/space-avionics-defense</a>
Transportation and Automotive	<a href="http://www.ti.com/automotive">www.ti.com/automotive</a>
Video and Imaging	<a href="http://www.ti.com/video">www.ti.com/video</a>
Wireless	<a href="http://www.ti.com/wireless-apps">www.ti.com/wireless-apps</a>

TI E2E Community Home Page

[e2e.ti.com](http://e2e.ti.com)

Mailing Address: Texas Instruments, Post Office Box 655303, Dallas, Texas 75265  
Copyright © 2011, Texas Instruments Incorporated