

## 3-TERMINAL POSITIVE VOLTAGE REGULATOR

### ■ GENERAL DESCRIPTION

The **NJM78L00** series of 3-Terminal Positive Voltage Regulators is constructed using the New JRC Planar epitaxial process. These regulators employ internal current-limiting and thermal-shutdown, making them essentially indestructible. If adequate heat sinking is provided, they can deliver up to 100mA output current. They are intended as fixed voltage regulators in a wide range of applications including local or on-card regulation for elimination of noise and distribution problems associated with single-point regulation. In addition, they can be used with power pass elements to make high-current voltage regulators. The **NJM78L00** series used as a Zener diode/resistor combination replacement, offers an effective output impedance improvement of typically two orders of magnitude, along with lower quiescent current and lower noise.

### ■ PACKAGE OUTLINE

(SOT-89)



**NJM78L00UA**

(EMP8)

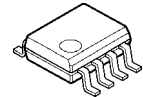

**NJM78L00EA**  
(5V, 9V, 12V Version Only)

### ■ FEATURES

- Internal Short Circuit Current Limit
- Internal Thermal Overload Protection
- Excellent Ripple Rejection
- Guarantee'd 100mA Output Current
- Package Outline
- Bipolar Technology

SOT-89, EMP8

### ■ PIN CONFIGURATION

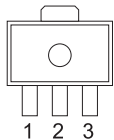

**NJM78L00UA**

PIN CONFIGURATION

1. OUT
2. GND
3. IN

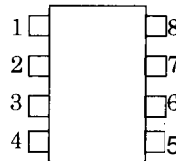

**NJM78L00EA**

PIN CONFIGURATION

1. OUT
2. GND
3. GND
4. NC
5. NC
6. GND
7. GND
8. IN

### ■ EQUIVALENT CIRCUIT

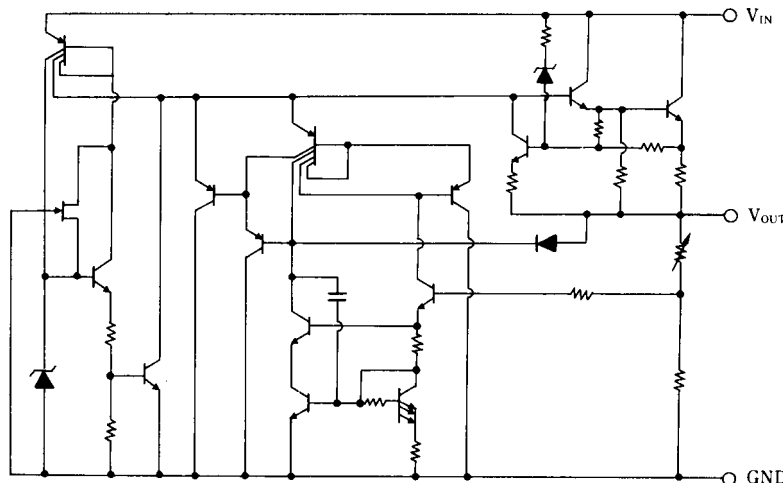

# NJM78L00

## ■ ABSOLUTE MAXIMUM RATINGS

(T<sub>a</sub>=25°C)

PARAMETER	SYMBOL	MAXIMUM RATINGS	UNIT
Input Voltage	V <sub>IN</sub>	(78L02A to 78L09A) 30	V
		(78L12A to 78L15A) 35	
		(78L18A to 78L24A) 40	
Power Dissipation	P <sub>D</sub>	(EMP8) 350 (SOT-89) 300	mW
Operating Temperature Range	T <sub>opr</sub>	-40 to +85	°C
Storage Temperature Range	T <sub>stg</sub>	-40 to +150	°C

## ■ ELECTRICAL CHARACTERISTICS(C<sub>IN</sub>=0.33μF, C<sub>O</sub>=0.1μF, T<sub>J</sub>=25°C)

Measurement is to be conducted is pulse testing.

PARAMETER	SYMBOL	TEST CONDITION	MIN.	TYP.	MAX.	UNIT
NJM78L02UA						
Output Voltage	V <sub>O</sub>	V <sub>IN</sub> =9V, I <sub>O</sub> =40mA	2.47	2.6	2.73	V
Line Regulation 1	ΔV <sub>O</sub> -V <sub>IN1</sub>	V <sub>IN</sub> =4.75V to 20V, I <sub>O</sub> =40mA	-	-	125	mV
Line Regulation 2	ΔV <sub>O</sub> -V <sub>IN2</sub>	V <sub>IN</sub> =5V to 20V, I <sub>O</sub> =40mA	-	-	100	mV
Load Regulation 1	ΔV <sub>O</sub> -I <sub>O1</sub>	V <sub>IN</sub> =9V, I <sub>O</sub> =1 to 40mA	-	-	25	mV
Load Regulation 2	ΔV <sub>O</sub> -I <sub>O2</sub>	V <sub>IN</sub> =9V, I <sub>O</sub> =1 to 100mA	-	-	50	mV
Quiescent Current	I <sub>Q</sub>	V <sub>IN</sub> =9V, I <sub>O</sub> =0mA	-	2.0	6	mA
Average Temperature Coefficient of Output Voltage	ΔV <sub>O</sub> /ΔT	V <sub>IN</sub> =9V, I <sub>O</sub> =1mA	-	0.2	-	mV/°C
Ripple Rejection	RR	6V < V <sub>IN</sub> < 16V, I <sub>O</sub> =40mA, e <sub>in</sub> =1V <sub>P-P</sub> , f=120Hz	43	73	-	dB
Output Noise Voltage	V <sub>NO</sub>	V <sub>IN</sub> =9V, BW=10Hz to 100kHz, I <sub>O</sub> =40mA	-	35	-	μV
NJM78L03UA						
Output Voltage	V <sub>O</sub>	V <sub>IN</sub> =9V, I <sub>O</sub> =40mA	2.85	3.0	3.15	V
Line Regulation 1	ΔV <sub>O</sub> -V <sub>IN1</sub>	V <sub>IN</sub> =5V to 20V, I <sub>O</sub> =40mA	-	-	125	mV
Line Regulation 2	ΔV <sub>O</sub> -V <sub>IN2</sub>	V <sub>IN</sub> =6V to 20V, I <sub>O</sub> =40mA	-	-	100	mV
Load Regulation 1	ΔV <sub>O</sub> -I <sub>O1</sub>	V <sub>IN</sub> =9V, I <sub>O</sub> =1 to 40mA	-	-	25	mV
Load Regulation 2	ΔV <sub>O</sub> -I <sub>O2</sub>	V <sub>IN</sub> =9V, I <sub>O</sub> =1 to 100mA	-	-	50	mV
Quiescent Current	I <sub>Q</sub>	V <sub>IN</sub> =9V, I <sub>O</sub> =0mA	-	2.0	6	mA
Average Temperature Coefficient of Output Voltage	ΔV <sub>O</sub> /ΔT	V <sub>IN</sub> =9V, I <sub>O</sub> =1mA	-	0.2	-	mV/°C
Ripple Rejection	RR	6V < V <sub>IN</sub> < 16V, I <sub>O</sub> =40mA, e <sub>in</sub> =1V <sub>P-P</sub> , f=120Hz	43	72	-	dB
Output Noise Voltage	V <sub>NO</sub>	V <sub>IN</sub> =9V, BW=10Hz to 100kHz, I <sub>O</sub> =40mA	-	40	-	μV
NJM78L05UA/EA						
Output Voltage	V <sub>O</sub>	V <sub>IN</sub> =10V, I <sub>O</sub> =40mA	4.75	5.0	5.25	V
Line Regulation 1	ΔV <sub>O</sub> -V <sub>IN1</sub>	V <sub>IN</sub> =7V to 20V, I <sub>O</sub> =40mA	-	-	200	mV
Line Regulation 2	ΔV <sub>O</sub> -V <sub>IN2</sub>	V <sub>IN</sub> =8V to 20V, I <sub>O</sub> =40mA	-	-	150	mV
Load Regulation 1	ΔV <sub>O</sub> -I <sub>O1</sub>	V <sub>IN</sub> =10V, I <sub>O</sub> =1 to 40mA	-	-	30	mV
Load Regulation 2	ΔV <sub>O</sub> -I <sub>O2</sub>	V <sub>IN</sub> =10V, I <sub>O</sub> =1 to 100mA	-	-	60	mV
Quiescent Current	I <sub>Q</sub>	V <sub>IN</sub> =10V, I <sub>O</sub> =0mA	-	2.0	6	mA
Average Temperature Coefficient of Output Voltage	ΔV <sub>O</sub> /ΔT	V <sub>IN</sub> =10V, I <sub>O</sub> =1mA	-	0.4	-	mV/°C
Ripple Rejection	RR	8V < V <sub>IN</sub> < 18V, I <sub>O</sub> =40mA, e <sub>in</sub> =1V <sub>P-P</sub> , f=120Hz	40	69	-	dB
Output Noise Voltage	V <sub>NO</sub>	V <sub>IN</sub> =10V, BW=10Hz to 100kHz, I <sub>O</sub> =40mA	-	70	-	μV

■ **ELECTRICAL CHARACTERISTICS**( $C_{IN}=0.33\mu F$ ,  $C_O=0.1\mu F$ ,  $T_j=25^\circ C$ )

Measurement is to be conducted is pulse testing.

PARAMETER	SYMBOL	TEST CONDITION	MIN.	TYP.	MAX.	UNIT
<b>NJM78L06UA</b>						
Output Voltage	$V_O$	$V_{IN}=12V$ , $I_O=40mA$	5.7	6.0	6.3	V
Line Regulation 1	$\Delta V_O-V_{IN1}$	$V_{IN}=8.5V$ to $20V$ , $I_O=40mA$	-	-	200	mV
Line Regulation 2	$\Delta V_O-V_{IN2}$	$V_{IN}=9V$ to $20V$ , $I_O=40mA$	-	-	150	mV
Load Regulation 1	$\Delta V_O-I_O1$	$V_{IN}=12V$ , $I_O=1$ to $40mA$	-	-	40	mV
Load Regulation 2	$\Delta V_O-I_O2$	$V_{IN}=12V$ , $I_O=1$ to $100mA$	-	-	80	mV
Quiescent Current	$I_Q$	$V_{IN}=12V$ , $I_O=0mA$	-	2.0	6	mA
Average Temperature Coefficient of Output Voltage	$\Delta V_O/\Delta T$	$V_{IN}=12V$ , $I_O=1mA$	-	0.5	-	mV/°C
Ripple Rejection	RR	$9V < V_{IN} < 20V$ , $I_O=40mA$ , $e_{in}=1V_{P-P}$ , $f=120Hz$	40	67	-	dB
Output Noise Voltage	$V_{NO}$	$V_{IN}=12V$ , $BW=10Hz$ to $100kHz$ , $I_O=40mA$	-	80	-	$\mu V$
<b>NJM78L07UA</b>						
Output Voltage	$V_O$	$V_{IN}=13V$ , $I_O=40mA$	6.65	7.0	7.35	V
Line Regulation 1	$\Delta V_O-V_{IN1}$	$V_{IN}=9.5V$ to $22V$ , $I_O=40mA$	-	-	210	mV
Line Regulation 2	$\Delta V_O-V_{IN2}$	$V_{IN}=10V$ to $22V$ , $I_O=40mA$	-	-	160	mV
Load Regulation 1	$\Delta V_O-I_O1$	$V_{IN}=13V$ , $I_O=1$ to $40mA$	-	-	45	mV
Load Regulation 2	$\Delta V_O-I_O2$	$V_{IN}=13V$ , $I_O=1$ to $100mA$	-	-	90	mV
Quiescent Current	$I_Q$	$V_{IN}=13V$ , $I_O=0mA$	-	2.1	6	mA
Average Temperature Coefficient of Output Voltage	$\Delta V_O/\Delta T$	$V_{IN}=13V$ , $I_O=1mA$	-	0.55	-	mV/°C
Ripple Rejection	RR	$10V < V_{IN} < 20V$ , $I_O=40mA$ , $e_{in}=1V_{P-P}$ , $f=120Hz$	39	66	-	dB
Output Noise Voltage	$V_{NO}$	$V_{IN}=13V$ , $BW=10Hz$ to $100kHz$ , $I_O=40mA$	-	100	-	$\mu V$
<b>NJM78L08UA</b>						
Output Voltage	$V_O$	$V_{IN}=14V$ , $I_O=40mA$	7.6	8.0	8.4	V
Line Regulation 1	$\Delta V_O-V_{IN1}$	$V_{IN}=10.5V$ to $23V$ , $I_O=40mA$	-	-	225	mV
Line Regulation 2	$\Delta V_O-V_{IN2}$	$V_{IN}=11V$ to $23V$ , $I_O=40mA$	-	-	175	mV
Load Regulation 1	$\Delta V_O-I_O1$	$V_{IN}=14V$ , $I_O=1$ to $40mA$	-	-	50	mV
Load Regulation 2	$\Delta V_O-I_O2$	$V_{IN}=14V$ , $I_O=1$ to $100mA$	-	-	100	mV
Quiescent Current	$I_Q$	$V_{IN}=14V$ , $I_O=0mA$	-	2.1	6	mA
Average Temperature Coefficient of Output Voltage	$\Delta V_O/\Delta T$	$V_{IN}=14V$ , $I_O=1mA$	-	0.6	-	mV/°C
Ripple Rejection	RR	$11V < V_{IN} < 20V$ , $I_O=40mA$ , $e_{in}=1V_{P-P}$ , $f=120Hz$	39	66	-	dB
Output Noise Voltage	$V_{NO}$	$V_{IN}=14V$ , $BW=10Hz$ to $100kHz$ , $I_O=40mA$	-	115	-	$\mu V$

# NJM78L00

## ■ ELECTRICAL CHARACTERISTICS ( $C_{IN}=0.33\mu F$ , $C_O=0.1\mu F$ , $T_J=25^\circ C$ )

Measurement is to be conducted is pulse testing.

PARAMETER	SYMBOL	TEST CONDITION	MIN.	TYP.	MAX.	UNIT
<b>NJM78L09UA/EA</b>						
Output Voltage	$V_O$	$V_{IN}=15V$ , $I_O=40mA$	8.55	9.0	9.45	V
Line Regulation 1	$\Delta V_O-V_{IN1}$	$V_{IN}=11.5V$ to $23V$ , $I_O=40mA$	-	-	250	mV
Line Regulation 2	$\Delta V_O-V_{IN2}$	$V_{IN}=12V$ to $23V$ , $I_O=40mA$	-	-	200	mV
Load Regulation 1	$\Delta V_O-I_O1$	$V_{IN}=15V$ , $I_O=1$ to $40mA$	-	-	50	mV
Load Regulation 2	$\Delta V_O-I_O2$	$V_{IN}=15V$ , $I_O=1$ to $100mA$	-	-	100	mV
Quiescent Current	$I_Q$	$V_{IN}=15V$ , $I_O=0mA$	-	2.1	6	mA
Average Temperature Coefficient of Output Voltage	$\Delta V_O/\Delta T$	$V_{IN}=15V$ , $I_O=1mA$	-	0.65	-	mV/ $^\circ C$
Ripple Rejection	RR	$12V < V_{IN} < 21V$ , $I_O=40mA$ , $e_{in}=1V_{P-P}$ , $f=120Hz$	38	65	-	dB
Output Noise Voltage	$V_{NO}$	$V_{IN}=15V$ , $BW=10Hz$ to $100kHz$ , $I_O=40mA$	-	125	-	$\mu V$
<b>NJM78L10UA</b>						
Output Voltage	$V_O$	$V_{IN}=16V$ , $I_O=40mA$	9.5	10.0	10.5	V
Line Regulation 1	$\Delta V_O-V_{IN1}$	$V_{IN}=13V$ to $25V$ , $I_O=40mA$	-	-	250	mV
Line Regulation 2	$\Delta V_O-V_{IN2}$	$V_{IN}=14V$ to $25V$ , $I_O=40mA$	-	-	200	mV
Load Regulation 1	$\Delta V_O-I_O1$	$V_{IN}=16V$ , $I_O=1$ to $40mA$	-	-	50	mV
Load Regulation 2	$\Delta V_O-I_O2$	$V_{IN}=16V$ , $I_O=1$ to $100mA$	-	-	100	mV
Quiescent Current	$I_Q$	$V_{IN}=16V$ , $I_O=0mA$	-	2.1	6	mA
Average Temperature Coefficient of Output Voltage	$\Delta V_O/\Delta T$	$V_{IN}=16V$ , $I_O=1mA$	-	0.7	-	mV/ $^\circ C$
Ripple Rejection	RR	$13V < V_{IN} < 22V$ , $I_O=40mA$ , $e_{in}=1V_{P-P}$ , $f=120Hz$	37	64	-	dB
Output Noise Voltage	$V_{NO}$	$V_{IN}=16V$ , $BW=10Hz$ to $100kHz$ , $I_O=40mA$	-	135	-	$\mu V$
<b>NJM78L12UA/EA</b>						
Output Voltage	$V_O$	$V_{IN}=19V$ , $I_O=40mA$	11.4	12.0	12.6	V
Line Regulation 1	$\Delta V_O-V_{IN1}$	$V_{IN}=14.5V$ to $27V$ , $I_O=40mA$	-	-	250	mV
Line Regulation 2	$\Delta V_O-V_{IN2}$	$V_{IN}=16V$ to $27V$ , $I_O=40mA$	-	-	200	mV
Load Regulation 1	$\Delta V_O-I_O1$	$V_{IN}=19V$ , $I_O=1$ to $40mA$	-	-	50	mV
Load Regulation 2	$\Delta V_O-I_O2$	$V_{IN}=19V$ , $I_O=1$ to $100mA$	-	-	100	mV
Quiescent Current	$I_Q$	$V_{IN}=19V$ , $I_O=0mA$	-	2.1	6.5	mA
Average Temperature Coefficient of Output Voltage	$\Delta V_O/\Delta T$	$V_{IN}=19V$ , $I_O=1mA$	-	0.9	-	mV/ $^\circ C$
Ripple Rejection	RR	$15V < V_{IN} < 25V$ , $I_O=40mA$ , $e_{in}=1V_{P-P}$ , $f=120Hz$	37	62	-	dB
Output Noise Voltage	$V_{NO}$	$V_{IN}=19V$ , $BW=10Hz$ to $100kHz$ , $I_O=40mA$	-	160	-	$\mu V$
<b>NJM78L15UA</b>						
Output Voltage	$V_O$	$V_{IN}=23V$ , $I_O=40mA$	14.3	15.0	15.7	V
Line Regulation 1	$\Delta V_O-V_{IN1}$	$V_{IN}=17.5V$ to $30V$ , $I_O=40mA$	-	-	300	mV
Line Regulation 2	$\Delta V_O-V_{IN2}$	$V_{IN}=20V$ to $30V$ , $I_O=40mA$	-	-	250	mV
Load Regulation 1	$\Delta V_O-I_O1$	$V_{IN}=23V$ , $I_O=1$ to $40mA$	-	-	75	mV
Load Regulation 2	$\Delta V_O-I_O2$	$V_{IN}=23V$ , $I_O=1$ to $100mA$	-	-	150	mV
Quiescent Current	$I_Q$	$V_{IN}=23V$ , $I_O=0mA$	-	2.2	6.5	mA
Average Temperature Coefficient of Output Voltage	$\Delta V_O/\Delta T$	$V_{IN}=23V$ , $I_O=1mA$	-	1.0	-	mV/ $^\circ C$
Ripple Rejection	RR	$18.5V < V_{IN} < 28.5V$ , $I_O=40mA$ , $e_{in}=1V_{P-P}$ , $f=120Hz$	34	60	-	dB
Output Noise Voltage	$V_{NO}$	$V_{IN}=23V$ , $BW=10Hz$ to $100kHz$ , $I_O=40mA$	-	190	-	$\mu V$

■ **ELECTRICAL CHARACTERISTICS**( $C_{IN}=0.33\mu F$ ,  $C_O=0.1\mu F$ ,  $T_J=25^\circ C$ )

Measurement is to be conducted is pulse testing.

PARAMETER	SYMBOL	TEST CONDITION	MIN.	TYP.	MAX.	UNIT
<b>NJM78L18UA</b>						
Output Voltage	$V_O$	$V_{IN}=27V, I_O=40mA$	17.1	18.0	18.9	V
Line Regulation 1	$\Delta V_O-V_{IN1}$	$V_{IN}=22V$ to $33V, I_O=40mA$	-	-	320	mV
Line Regulation 2	$\Delta V_O-V_{IN2}$	$V_{IN}=22V$ to $33V, I_O=40mA$	-	-	270	mV
Load Regulation 1	$\Delta V_O-I_O1$	$V_{IN}=27V, I_O=1$ to $40mA$	-	-	80	mV
Load Regulation 2	$\Delta V_O-I_O2$	$V_{IN}=27V, I_O=1$ to $100mA$	-	-	160	mV
Quiescent Current	$I_Q$	$V_{IN}=27V, I_O=0mA$	-	2.2	6.5	mA
Average Temperature Coefficient of Output Voltage	$\Delta V_O/\Delta T$	$V_{IN}=27V, I_O=1mA$	-	1.1	-	mV/°C
Ripple Rejection	RR	$23V < V_{IN} < 33V, I_O=40mA, e_{in}=1V_{P-P}, f=120Hz$	33	59	-	dB
Output Noise Voltage	$V_{NO}$	$V_{IN}=27V, BW=10Hz$ to $100kHz, I_O=40mA$	-	230	-	$\mu V$
<b>NJM78L20UA</b>						
Output Voltage	$V_O$	$V_{IN}=29V, I_O=40mA$	19.0	20.0	21.0	V
Line Regulation 1	$\Delta V_O-V_{IN1}$	$V_{IN}=23V$ to $34V, I_O=40mA$	-	-	330	mV
Line Regulation 2	$\Delta V_O-V_{IN2}$	$V_{IN}=24V$ to $34V, I_O=40mA$	-	-	280	mV
Load Regulation 1	$\Delta V_O-I_O1$	$V_{IN}=29V, I_O=1$ to $40mA$	-	-	90	mV
Load Regulation 2	$\Delta V_O-I_O2$	$V_{IN}=29V, I_O=1$ to $100mA$	-	-	180	mV
Quiescent Current	$I_Q$	$V_{IN}=29V, I_O=0mA$	-	2.3	7	mA
Average Temperature Coefficient of Output Voltage	$\Delta V_O/\Delta T$	$V_{IN}=29V, I_O=1mA$	-	1.2	-	mV/°C
Ripple Rejection	RR	$24V < V_{IN} < 34V, I_O=40mA, e_{in}=1V_{P-P}, f=120Hz$	32	58	-	dB
Output Noise Voltage	$V_{NO}$	$V_{IN}=29V, BW=10Hz$ to $100kHz, I_O=40mA$	-	250	-	$\mu V$
<b>NJM78L24UA</b>						
Output Voltage	$V_O$	$V_{IN}=33V, I_O=40mA$	22.8	24	25.2	V
Line Regulation 1	$\Delta V_O-V_{IN1}$	$V_{IN}=27V$ to $38V, I_O=40mA$	-	-	350	mV
Line Regulation 2	$\Delta V_O-V_{IN2}$	$V_{IN}=28V$ to $38V, I_O=40mA$	-	-	300	mV
Load Regulation 1	$\Delta V_O-I_O1$	$V_{IN}=33V, I_O=1$ to $40mA$	-	-	100	mV
Load Regulation 2	$\Delta V_O-I_O2$	$V_{IN}=33V, I_O=1$ to $100mA$	-	-	200	mV
Quiescent Current	$I_Q$	$V_{IN}=33V, I_O=0mA$	-	2.3	7	mA
Average Temperature Coefficient of Output Voltage	$\Delta V_O/\Delta T$	$V_{IN}=33V, I_O=1mA$	-	1.4	-	mV/°C
Ripple Rejection	RR	$27.5V < V_{IN} < 37.5V, I_O=40mA, e_{in}=1V_{P-P}, f=120Hz$	32	57	-	dB
Output Noise Voltage	$V_{NO}$	$V_{IN}=33V, BW=10Hz$ to $100kHz, I_O=40mA$	-	280	-	$\mu V$

■ **SOT-89 MARK**

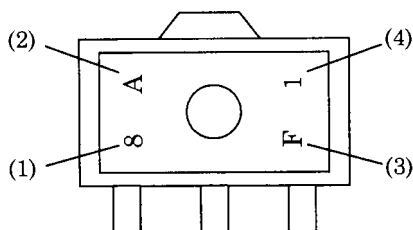

- (1) 8 : Positive Output
  - (2)  $V_O$  Rank
  - (3) The end of A.D.
  - (4) Production Mouth
- Oct. ...X  
Nov. ...Y  
Dec. ...Z

NJM78L02UA	8	A
NJM78L03UA	8	B
NJM78L05UA	8	C
NJM78L06UA	8	E
NJM78L07UA	8	F
NJM78L08UA	8	G
NJM78L09UA	8	H
NJM78L10UA	8	J
NJM78L12UA	8	K
NJM78L15UA	8	L
NJM78L18UA	8	M
NJM78L20UA	8	N
NJM78L24UA	8	P

# NJM78L00

## ■ TEST CIRCUIT

1. Output Voltage, Line Regulation, Load Regulation, Quiescent Current, Average Temperature Coefficient of Output Voltage, Output Noise Voltage, Peak Output/Short-Circuit Current

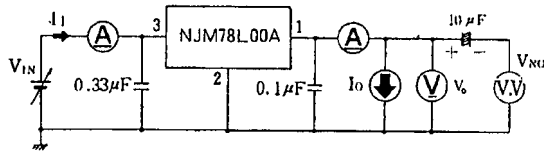

○ Measurement is to be conducted in pulse testing.  
 ○  $I_Q = I_1 - I_o$

2. Ripple Rejection

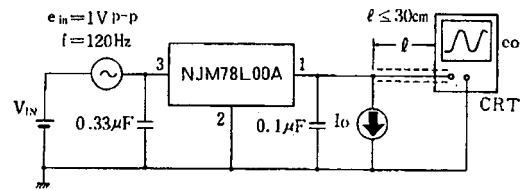

$$RR = 20 \log_{10} \left( \frac{e_{in}}{e_o} \right) \text{ (dB)}$$

## ■ POWER DISSIPATION VS. AMBIENT TEMPERATURE

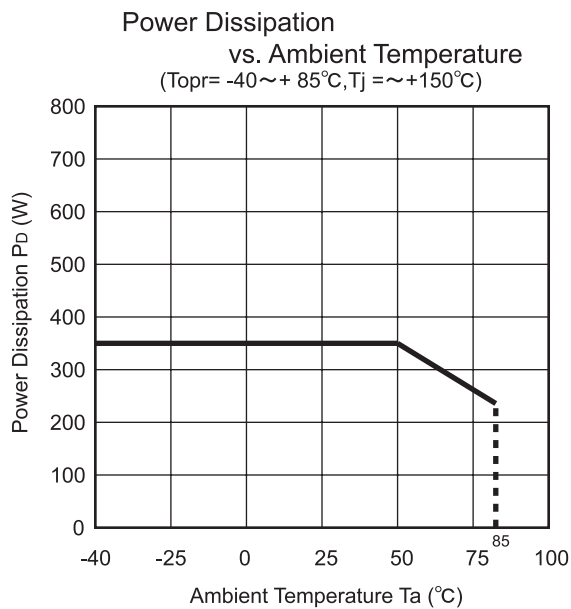

## ■ TYPICAL CHARACTERISTICS

**NJM78L05 / L12 / L24**  
**Output Characteristics**

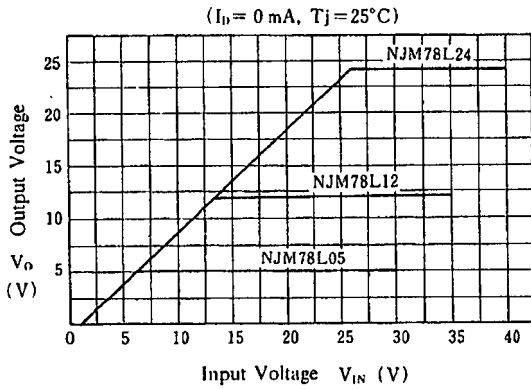

**NJM78L05 Dropout Characteristics**

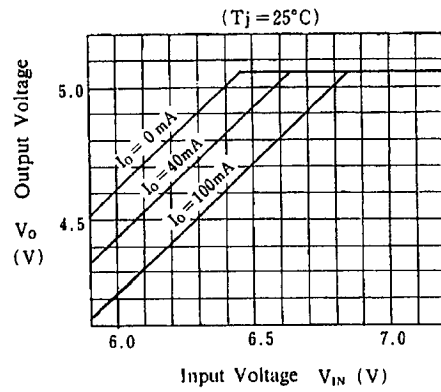

**NJM78L00 Series Short Circuit**  
**Output Current**

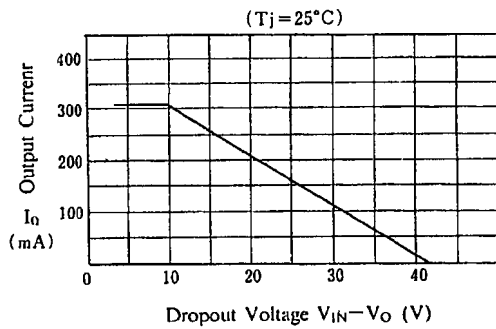

**NJM78L02 / L24 Quiescent Current**  
**vs. Output Current**

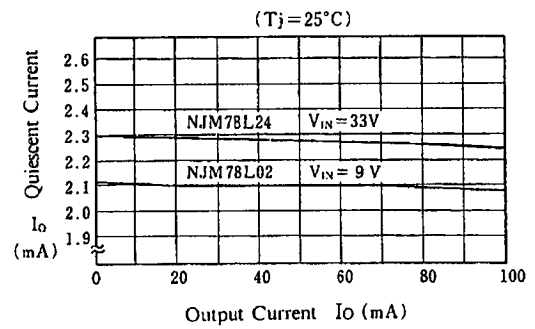

**NJM78L05 Quiescent Current**  
**vs. Input Voltage**

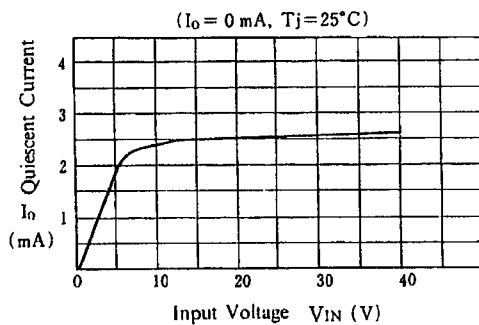

# NJM78L00

## ■ TYPICAL CHARACTERISTICS

### NJM78L05 / L12 / L24

#### Thermal Shutdown Characteristics

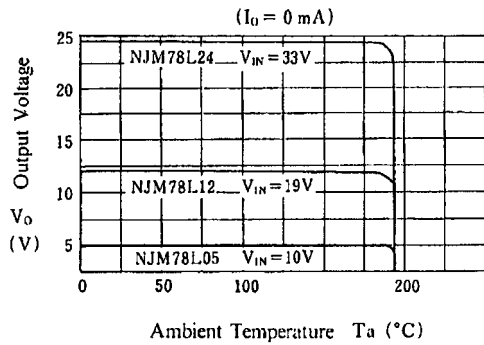

### NJM78L05 / L12 / L24

#### Load Characteristics

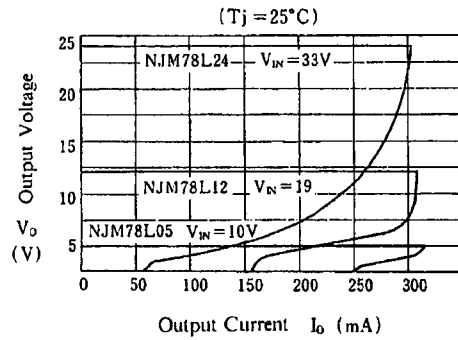

### NJM78L02 / L24 Ripple Rejection

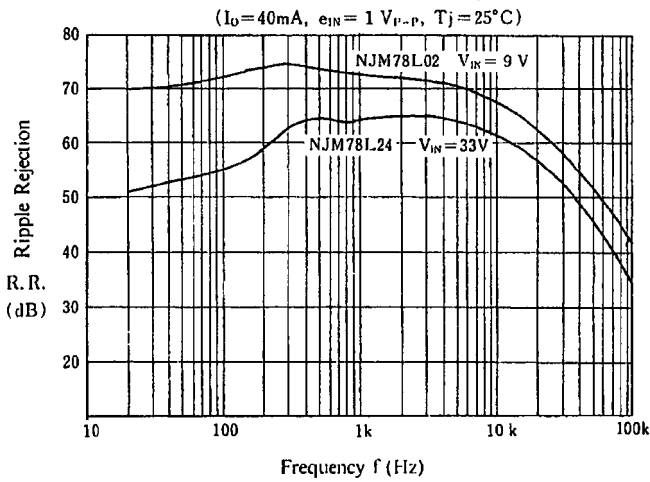

### NJM78L05 Output Voltage vs. Temperature

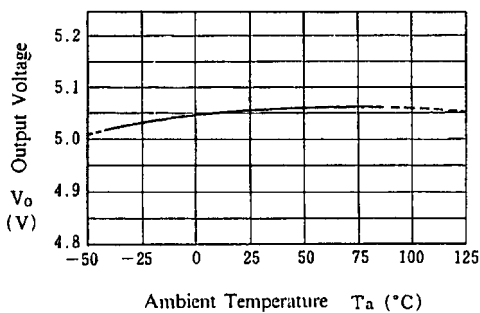

### NJM78L12 Output Voltage vs. Temperature

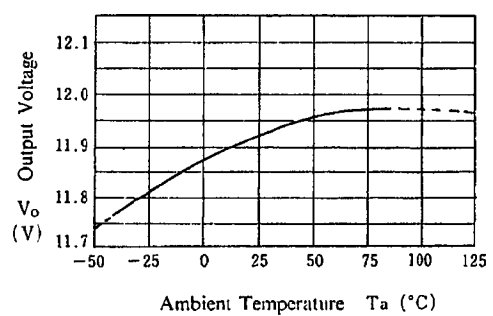

#### [CAUTION]

The specifications on this databook are only given for information, without any guarantee as regards either mistakes or omissions. The application circuits in this databook are described only to show representative usages of the product and not intended for the guarantee or permission of any right including the industrial rights.