

T-1 3/4 (5 mm) Oval Precision Optical Performance LED Lamps

Technical Data

Sun Power Series

HLMP-ABxx **HLMP-BBxx**
HLMP-ADxx **HLMD-BDxx**
HLMP-AGxx **HLMP-BGxx**
HLMP-ALxx **HLMP-BLxx**
HLMP-AMxx **HLMP-BMxx**

Features

- **Smooth, Consistent Spatial Radiation Patterns**
- **Wide Viewing Angle**
Major Axis 70°
Minor Axis 35°
- **High Luminous Output**
- **Two Red and Amber Intensity Levels Available:**
AlInGaP (bright) and AlInGaP II (brightest)
- **Colors:**
472 nm Blue
526 nm Green
590/592 nm Amber
626/630 nm Red
- **Superior Resistance to Moisture**
- **UV Resistant Epoxy**
- **Choice of Package Options**

Applications

- **Full Color/Video Signs**
- **Variable Message Signs**
Passenger Information
Advertising
Time/Temperature

Benefits

- **Viewing Angle Designed for Wide Field of View Applications**
- **Red, Green, and Blue Radiation Patterns Matched for Full Color Signs**
- **Superior Outdoor Environmental Performance**

Description

These Precision Optical Performance oval LEDs are specifically designed for Full Color/Video and Passenger Information signs. The oval shaped radiation pattern (35° x 70°) and high luminous intensity ensure that these devices are excellent for wide field of view outdoor applications where a wide viewing angle and readability in sunlight are essential. These lamps have very smooth, matched radiation patterns ensuring consistent color mixing in full color applications, and message uniformity across the viewing angle of the sign.

High efficiency LED materials are used in these lamps: Aluminum Indium Gallium Phosphide (AlInGaP) for amber and red, and Indium Gallium Nitride (InGaN)

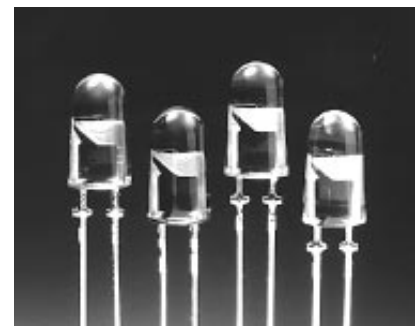

for blue and green. There are two families of red and amber lamps, AlInGaP and the higher performance AlInGaP II. Each lamp is made with an advanced optical grade epoxy offering superior high temperature and high moisture resistance in outdoor applications. The package epoxy contains both UV-a and UV-b inhibitors to reduce the effects of long term exposure to direct sunlight.

Designers can select parallel (where the axis of the leads is parallel to the wide axis of the oval radiation pattern) or perpendicular orientation. Designers can also choose between lamps with or without standoffs. The red and amber lamps are available in tinted versions.

CAUTION: The Blue and Green LEDs are Class 1 ESD sensitive. Please observe appropriate precautions during handling and processing. Refer to Agilent Application Note AN-1142 for additional details.

Package Dimensions

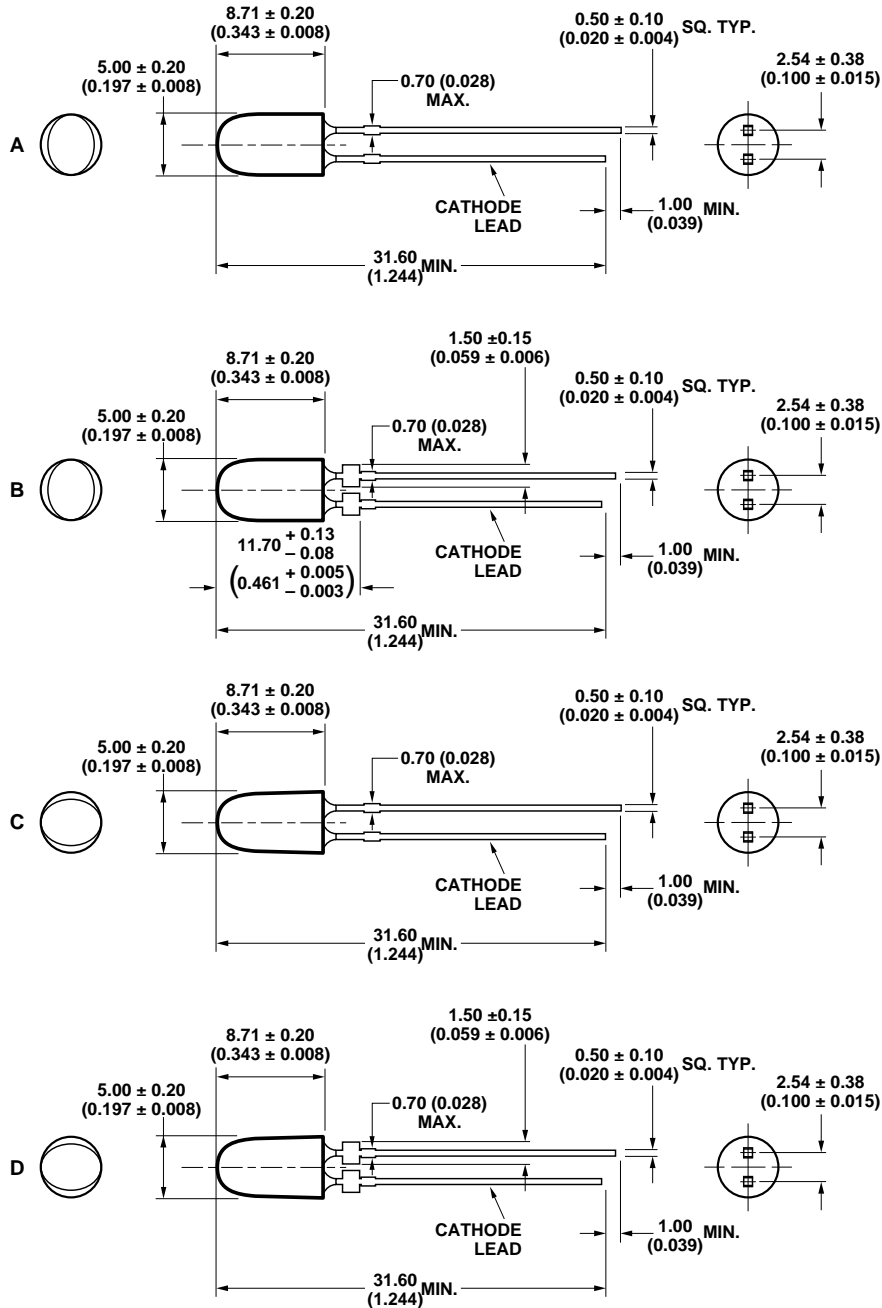

NOTES:

- ALL DIMENSIONS ARE IN MILLIMETERS (INCHES).
- LEADS ARE MILD STEEL, SOLDER DIPPED.
- TAPERS SHOWN AT TOP OF LEADS (BOTTOM OF LAMP PACKAGE) INDICATE AN EPOXY MENISCUS THAT MAY EXTEND ABOUT 1 mm (0.040 IN.) DOWN THE LEADS.
- RECOMMENDED PC BOARD HOLE DIAMETERS:
 - LAMP PACKAGES A AND C WITHOUT STAND-OFFS: FLUSH MOUNTING AT BASE OF LAMP PACKAGE = $1.143/1.067$ mm ($0.044/0.042$ IN.).
 - LAMP PACKAGES B AND D WITH STAND-OFFS: MOUNTING AT LEAD STAND-OFFS.

Part Numbering Scheme**HLMP-(1)(2)(3)(4)***where (1) = Leadframe**Orientation*

“A” = Parallel

“B” = Perpendicular

where (2) = Color Option

“L” = 590/592 nm Amber

“G” = 626 nm Red

“D” = 630 nm Red

“M” = 525 nm Green

“B” = 472 nm Blue

where (3) = Standoff Option

“0” = Without

“1” = With

where (4) = Tint Option“1” or “6” = Matching Color
Tints**Refer to selection guides for
available combinations.****AllInGaP Device Selection Guide (Amber, Red)**

Part Number	Color and Typical Dominant Wavelength λ_d(nm)	Luminous Intensity I_V(mcd) at 20 mA Min.	Luminous Intensity I_V(mcd) at 20 mA Typ.	Tinting Type	Leads with Stand-Offs	Lead Frame Orientation	Package Drawing
HLMP-AL01	Amber 590	270	600	Amber	No	Parallel	A
HLMP-AL11	Amber 590	270	600	Amber	Yes	Parallel	B
HLMP-BL01	Amber 590	270	600	Amber	No	Perpendicular	C
HLMP-BL11	Amber 590	270	600	Amber	Yes	Perpendicular	D
HLMP-AG01	Red 626	270	600	Red	No	Parallel	A
HLMP-AG11	Red 626	270	600	Red	Yes	Parallel	B
HLMP-BG01	Red 626	270	600	Red	No	Perpendicular	C
HLMP-BG11	Red 626	270	600	Red	Yes	Perpendicular	D

Notes:

1. The luminous intensity is measured on the mechanical axis of the lamp package.
2. The optical axis is closely aligned with the package mechanical axis.
3. The dominant wavelength λ_d , is derived from the CIE Chromaticity Diagram and represents the color of the lamp.

AllInGaP2 Device Selection Guide (Amber, Red)

Part Number	Color and Typical Dominant Wavelength λ_d (nm)	Luminous Intensity I_V (mcd) at 20 mA Min.	Luminous Intensity I_V (mcd) at 20 mA Typ.	Tinting Type	Leads with Stand-Offs	Lead Frame Orientation	Package Drawing
HLMP-AL06	Amber 592	590	1300	Amber	No	Parallel	A
HLMP-AL16	Amber 592	590	1300	Amber	Yes	Parallel	B
HLMP-BL06	Amber 592	590	1300	Amber	No	Perpendicular	C
HLMP-BL16	Amber 592	590	1300	Amber	Yes	Perpendicular	D
HLMP-AD06	Red 630	590	1300	Red	No	Parallel	A
HLMP-AD16	Red 630	590	1300	Red	Yes	Parallel	B
HLMP-BD06	Red 630	590	1300	Red	No	Perpendicular	C
HLMP-BD16	Red 630	590	1300	Red	Yes	Perpendicular	D

InGaN Device Selection Guide (Blue, Green)

Part Number	Color and Typical Dominant Wavelength λ_d (nm)	Luminous Intensity I_V (mcd) at 20 mA Min.	Luminous Intensity I_V (mcd) at 20 mA Typ.	Tinting Type	Leads with Stand-Offs	Lead Frame Orientation	Package Drawing
HLMP-AM01	Green 526	590	1300	Green	No	Parallel	A
HLMP-AM11	Green 526	590	1300	Green	Yes	Parallel	B
HLMP-BM01	Green 526	590	1300	Green	No	Perpendicular	C
HLMP-BM11	Green 526	590	1300	Green	Yes	Perpendicular	D
HLMP-AB01	Blue 472	205	400	Blue	No	Parallel	A
HLMP-AB11	Blue 472	205	400	Blue	Yes	Parallel	B
HLMP-BB01	Blue 472	205	400	Blue	No	Perpendicular	C
HLMP-BB11	Blue 472	205	400	Blue	Yes	Perpendicular	D

Notes:

1. The luminous intensity is measured on the mechanical axis of the lamp package.
2. The optical axis is closely aligned with the package mechanical axis.
3. The dominant wavelength λ_d , is derived from the CIE Chromaticity Diagram and represents the color of the lamp.

Absolute Maximum Ratings at 25°C

	Amber and Red	Blue and Green
DC Forward Current	50 mA	30 mA
Peak Pulsed Forward Current	100 mA	100 mA
Average Forward Current (Pulsed Operation)	30 mA ^[1]	30 mA
Reverse Voltage ($I_R = 100 \mu\text{A}$)	5 V	
Reverse Voltage ($I_R = 10 \mu\text{A}$)		5 V
Power Dissipation	120 mW	120 mW
LED Junction Temperature	130°C	100°C
Operating Temperature Range	-40°C to +100°C	-40°C to +80°C
Storage Temperature Range	-40°C to +120°C	-40°C to +100°C
Soldering Temperature	260°C for 5 sec.	260°C for 5 sec.

Note:

1. Higher pulsed average currents can be used under certain conditions. Refer to Agilent Application Brief I-024.

Intensity Bin Limits (mcd at 20 mA)

Bin Name	Min.	Max.
G	140	180
H	180	240
J	240	310
K	310	400
L	400	520
M	520	680
N	680	880
P	880	1150
Q	1150	1500
R	1500	1900
S	1900	2500

Tolerance for each bin limit is $\pm 15\%$.

Amber Bin Limits (nm at 20 mA)

Bin Name	Min.	Max.
1	584.5	587.0
2	587.0	589.5
4	589.5	592.0
6	592.0	594.5

Tolerance for each bin limit is ± 0.5 nm.

Blue Color Bin Limits (nm at 20 mA)

Bin Name	Min.	Max.
1	460.0	464.0
2	464.0	468.0
3	468.0	472.0
4	472.0	476.0
5	476.0	480.0

Tolerance for each bin limit is ± 2 nm.

Green Color Bin Limits (nm at 20 mA)

Bin Name	Min.	Max.
1	520.0	524.0
2	524.0	528.0
3	528.0	532.0
4	532.0	536.0
5	536.0	540.0

Tolerance for each bin limit is ± 0.5 nm.

Note:

1. Bin categories are established for classification of products. Products may not be available in all bin categories. Please contact your Agilent representative for information on currently available bins.

Electrical/Optical Characteristics at $T_A = 25^\circ\text{C}$

Parameter	Symbol	Min.	Typ.	Max.	Units	Test Conditions
Typical Viewing Angle Major Minor	$2\theta_{1/2}$		70 35		$^\circ\text{C}$	
Forward Voltage Amber ($\lambda_d = 590\text{ nm}$) Amber ($\lambda_d = 592\text{ nm}$) Red ($\lambda_d = 626\text{ nm}$) Red ($\lambda_d = 630\text{ nm}$) Blue ($\lambda_d = 472\text{ nm}$) Green ($\lambda_d = 526\text{ nm}$)	V_F		2.02 2.15 1.90 2.00 3.5 3.5	2.4 2.4 2.4 2.4 4.0 4.0	V	$I_F = 20\text{ mA}$
Reverse Voltage Amber, Red Blue, Green	V_R	5 5	20 -		V	$I_F = 100\ \mu\text{A}$ $I_F = 10\ \mu\text{A}$
Peak Wavelength Amber ($\lambda_d = 590\text{ nm}$) Amber ($\lambda_d = 592\text{ nm}$) Red ($\lambda_d = 626\text{ nm}$) Red ($\lambda_d = 630\text{ nm}$) Blue ($\lambda_d = 472\text{ nm}$) Green ($\lambda_d = 526\text{ nm}$)	λ_{peak}		592 594 635 639 470 524		nm	Peak of Wavelength of Spectral Distribution at $I_F = 20\text{ mA}$
Spectral Halfwidth Amber ($\lambda_d = 590/592\text{ nm}$) Red ($\lambda_d = 626/630\text{ nm}$) Blue ($\lambda_d = 472\text{ nm}$) Green ($\lambda_d = 526\text{ nm}$)	$\Delta\lambda_{1/2}$		17 17 35 47		nm	Wavelength Width at Spectral Distribution 1/2 Power Point at $I_F = 20\text{ mA}$
Capacitance Amber, Red Blue, Green	C		40 43		pF	$V_F = 0, F = 1\text{ MHz}$
Thermal Resistance Amber, Red Blue, Green	$R\theta_{J-PIN}$		240 240		$^\circ\text{C/W}$	LED Junction- to-Cathode Lead
Luminous Efficacy Amber ($\lambda_d = 590\text{ nm}$) Amber ($\lambda_d = 592\text{ nm}$) Red ($\lambda_d = 626\text{ nm}$) Red ($\lambda_d = 630\text{ nm}$) Blue ($\lambda_d = 472\text{ nm}$) Green ($\lambda_d = 526\text{ nm}$)	η_V		480 500 150 155 75 520		lm/W	Emitted Luminous Power/Emitted Radiant Power

Notes:

- $2\theta_{1/2}$ is the off-axis angle where the luminous intensity is 1/2 the on-axis intensity.
- The radiant intensity, I_e in watts per steradian, may be found from the equation $I_e = I_v/\eta_v$ where I_v is the luminous intensity in candelas and η_v is the luminous efficacy in lumens/watt.

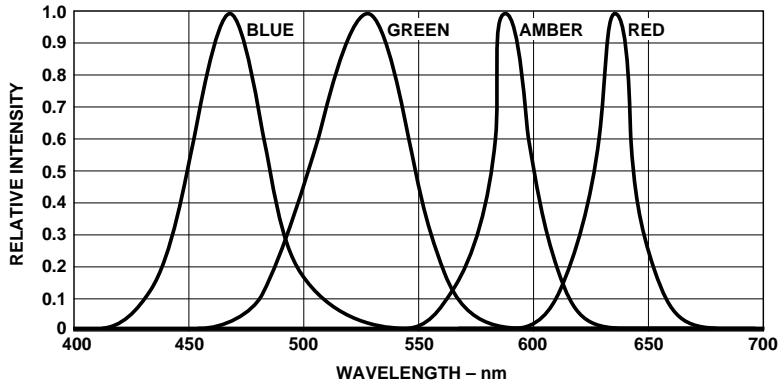

Figure 1. Relative Intensity vs. Wavelength.

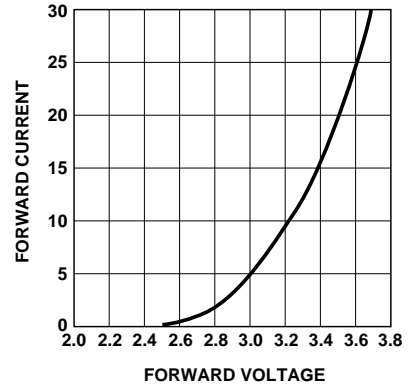

Figure 2. Blue, Green Forward Current vs. Forward Voltage.

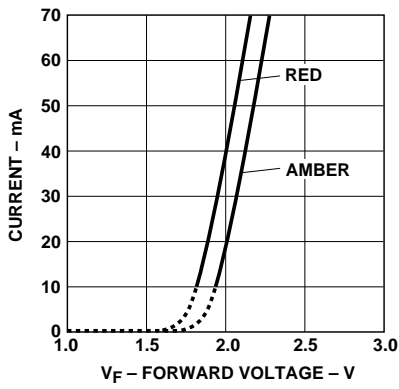

Figure 3. Amber, Red Forward Current vs. Forward Voltage.

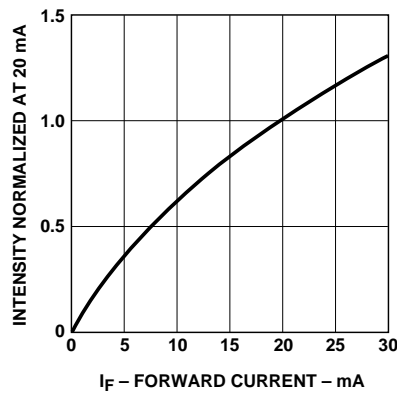

Figure 4. Blue, Green Relative Luminous Intensity vs. Forward Current.

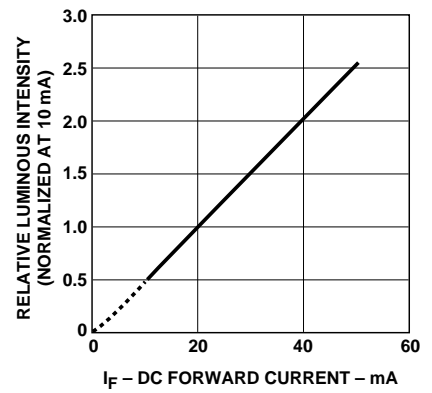

Figure 5. Amber, Red Relative Luminous Intensity vs. Forward Current.

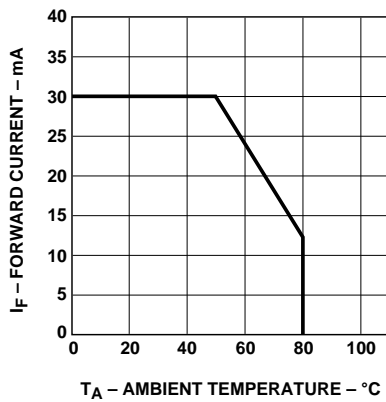

Figure 6. Blue, Green Maximum Forward Current vs. Ambient Temperature.

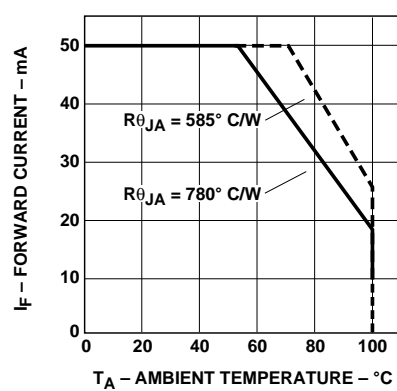

Figure 7. Amber, Red Maximum Forward Current vs. Ambient Temperature.

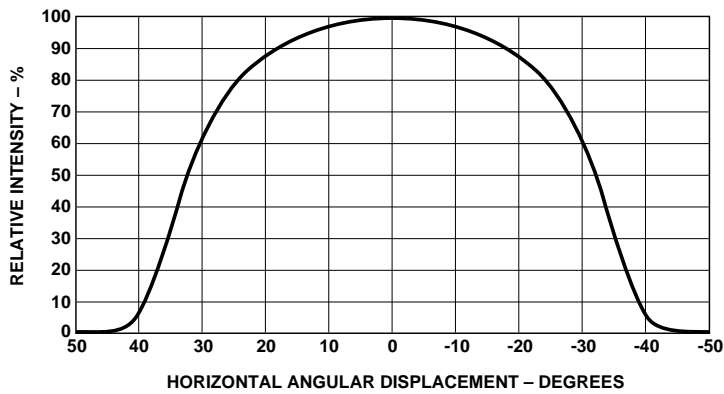
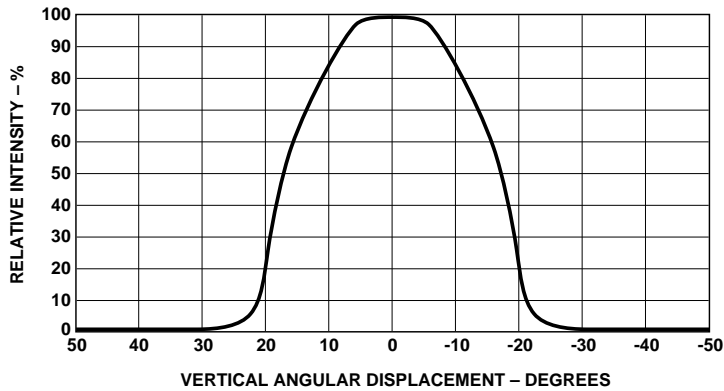

Figure 8. Spatial Radiation Pattern – 35 x 70 Degree Lamps.

www.agilent.com/semiconductors

For product information and a complete list of distributors, please go to our web site.

For technical assistance call:

Americas/Canada: +1 (800) 235-0312 or
(408) 654-8675

Europe: +49 (0) 6441 92460

China: 10800 650 0017

Hong Kong: (+65) 6271 2451

India, Australia, New Zealand: (+65) 6271 2394

Japan: (+81 3) 3335-8152(Domestic/International), or 0120-61-1280(Domestic Only)

Korea: (+65) 6271 2194

Malaysia, Singapore: (+65) 6271 2054

Taiwan: (+65) 6271 2654

Data subject to change.

Copyright © 2002 Agilent Technologies, Inc.

Obsoletes 5980-0672E

July 10, 2002

5988-7308EN