

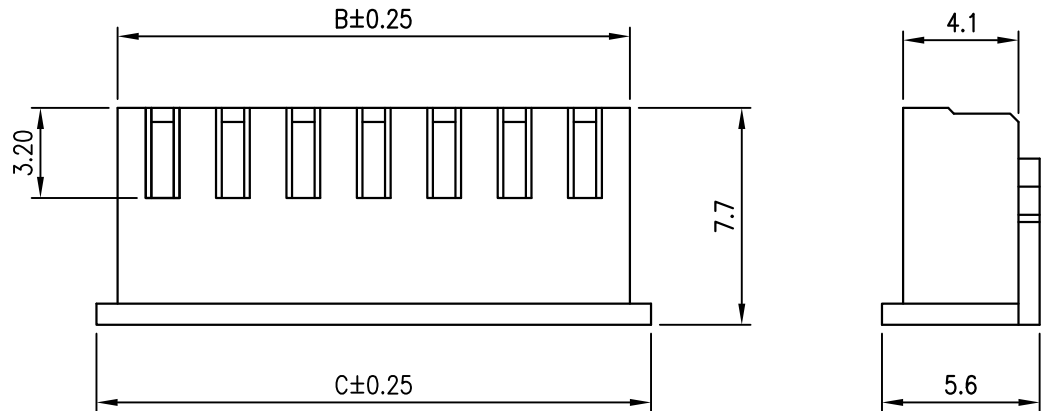

C **YI** US E182481

REV	DESCRIPTION	DATE



NOTES

Available in 02 through 20 Circuits
 Material: Nylon 66 UL94-V0
 Accepts YY-1300-T Crimp Terminal
 Mates with YY-1300-W**S or YY-1300-W**R Series Header

ORDERING INFORMATION

YY-1300 - H ** - *
 1 2 3

- H : Housing
- No. of Circuits 02~20
- Color
 : Nature
 A : Black
 C : Red
 E : Yellow
 G : Blue

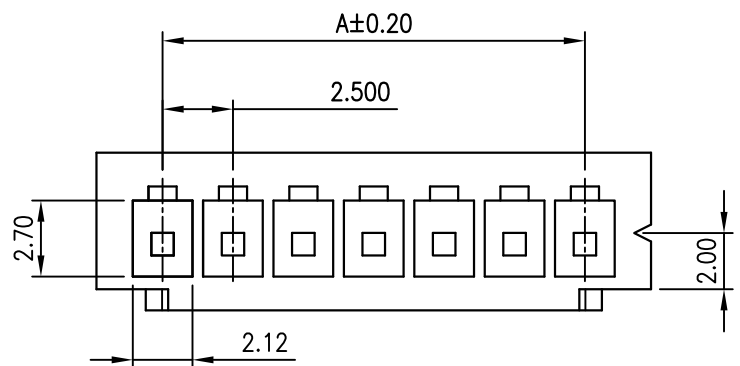

Circuits	Dimension mm			Circuits	Dimension mm			Circuits	Dimension mm		
	A	B	C		A	B	C		A	B	C
2	2.50	5.70	7.30	9	20.00	23.20	24.80	16	37.50	40.70	42.30
3	5.00	8.20	9.80	10	22.50	25.70	27.30	17	40.00	43.20	44.70
4	7.50	10.70	12.30	11	25.00	28.20	29.80	18	42.50	45.70	47.20
5	10.00	13.20	14.80	12	27.50	30.70	32.30	19	45.00	48.20	49.70
6	12.50	15.70	17.30	13	30.00	33.20	34.80	20	47.50	50.70	52.20
7	15.00	18.20	19.80	14	32.50	35.70	37.30	--	--	--	--
8	17.50	20.70	22.30	15	35.00	38.20	39.80	--	--	--	--

TOLERANCE X. -- X.X ±0.25 X.XX ±0.15 X.XXX ±0.05 ANGULAR --			
APPROVALS DRAWN Frank 22-September-2009 CHECKED Denise 22-September-2009 APPROVED Jessica 22-September-2009			
VIEW 	SCALE 4:1	PART NO. YY-1300-H***-*	REV. A0
UNIT MM	SIZE A4	DWG NO. YY-1300-H***-*-014	SHEET 1 OF 1

Young Yak
 2009.09.26
 ISSUED



C **YI** US E182481

REV	DESCRIPTION	DATE

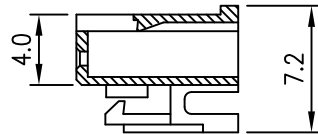
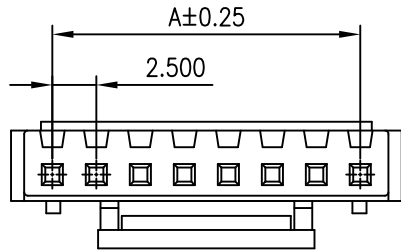

NOTES

Available in 02 through 16 Circuits
 Material: Nylon 66 UL94-V0
 Accepts YY-1300-T Crimp Terminal
 Mates with YY-1300-W**S or YY-1300-W**R Series Header

ORDERING INFORMATION

YY-1300 - H ** L
 1 2 3

- 1. H : Housing
- 2. No. of Circuits 02~16
- 3. L : Lock

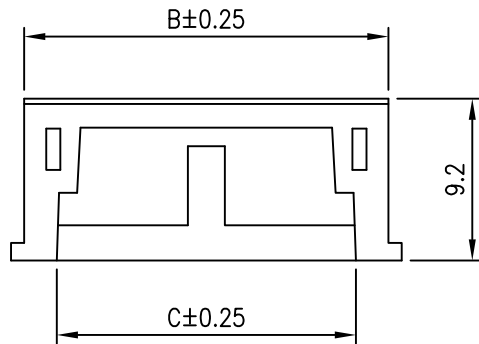

07~16P

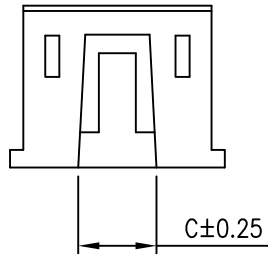

04~06P

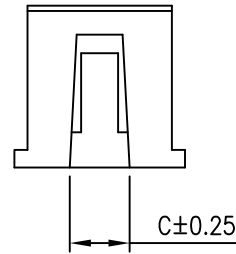

02~03P

Circuits	Dimension mm			Circuits	Dimension mm		
	A	B	C		A	B	C
2	2.50	5.70	2.10	10	22.50	25.70	7.25
3	5.00	8.20	3.40	11	25.00	28.20	16.95
4	7.50	10.70	3.40	12	27.50	30.70	16.95
5	10.00	13.20	4.45	13	30.00	33.20	16.95
6	12.50	15.70	4.45	14	32.50	35.70	17.25
7	15.00	18.20	6.55	15	35.00	38.20	19.75
8	17.50	20.70	6.55	16	37.50	40.70	19.75
9	20.00	23.20	7.25	--	--	--	--

TOLERANCE					
X.	--	Young Yak Enterprise Co., Ltd. TITLE: 2.5mm(.098") Pitch Wire to Board Housing			
X.X	±0.25				
X.XX	±0.15				
X.XXX	±0.05				
ANGULAR	--				
APPROVALS					
DRAWN	Frank	VIEW	SCALE	PART NO.	REV.
	22-September-2009		F	YY-1300-H**L	A0
CHECKED	Denise	UNIT	SIZE	DWG NO.	SHEET
	22-September-2009	MM	A4	YY-1300-H**L-014	1 OF 1
APPROVED	Jessica				
	22-September-2009				





C **YI** US E182481

REV	DESCRIPTION	DATE

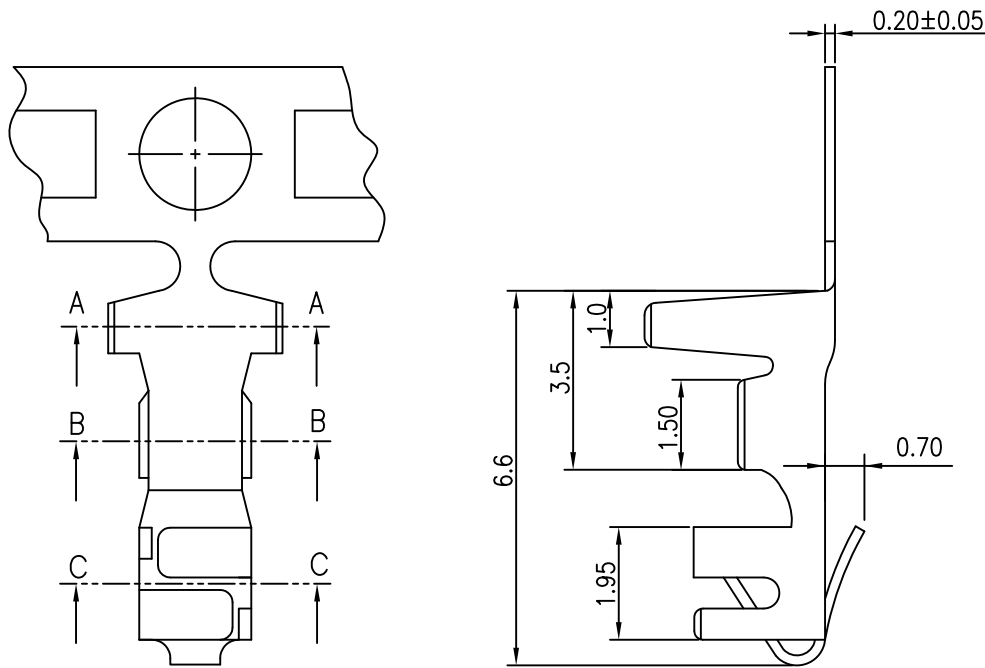

NOTES

Used in YY-1300-H Series Housing
 Accepts AWG #22~28 Wire Range
 Insulation O.D.= 1.90 mm(max)
 Material : Brass or Phosphor Bronze
 Finish : Tin , Pre-tinned
 Qty/Reel : 8,000 PCS
 Thickness: 0.2mm

ORDERING INFORMATION

YY-1300 - T TA *
 1 2 3

- 1. T : Terminal
- 2. TA : Tin , Pre-tinned
- 3. Material
 - : BRASS
 - P : Phosphor bronze

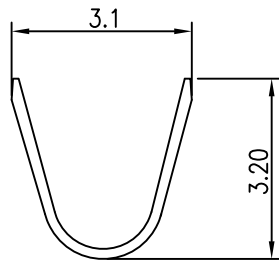

A-A

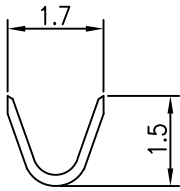

B-B

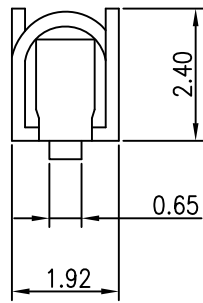

C-C



TOLERANCE	
X.	--
X.X	±0.25
X.XX	±0.13
X.XXX	±0.05
ANGULAR	--
APPROVALS	
DRAWN	Frank 22-September-2009
CHECKED	Denise 22-September-2009
APPROVED	Jessica 22-September-2009



Young Yak Enterprise Co., Ltd.

TITLE
 3.0mm(.118") Pitch
 Wire to Board Terminal

VIEW	SCALE	PART NO.	REV.
	F	YY-1300-TTA*	A0
UNIT	SIZE	DWG NO.	SHEET
MM	A4	YY-1300-TTA*-094	1 OF 1



C **RI** US E182481

REV	DESCRIPTION	DATE

NOTES

Available in 02 through 20 Circuits
 Material: Nylon 66 UL94-V0
 Mates with YY-1300-H Series Housing
 0.64mm(.025") Square Pin
 Pin Material: Brass/Tin-Plated or Gold-Plated

ORDERING INFORMATION

YY-1300 - W ** S * * - *
1 2 3 4 5

- No. of Circuits 02~20
- S : Straight
- Plated
 T : Tin G : Gold
- S : Without Kink
 □ : Standard(With Kink)
- Color
 □ : Nature
 A : BLACK C : RED

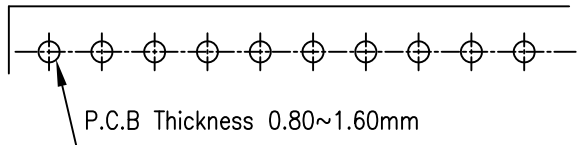
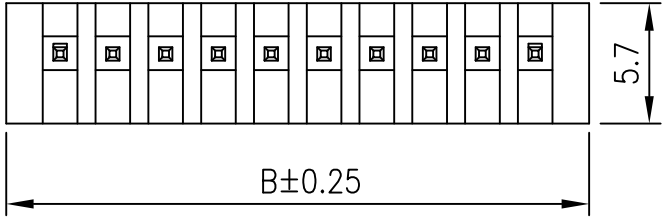
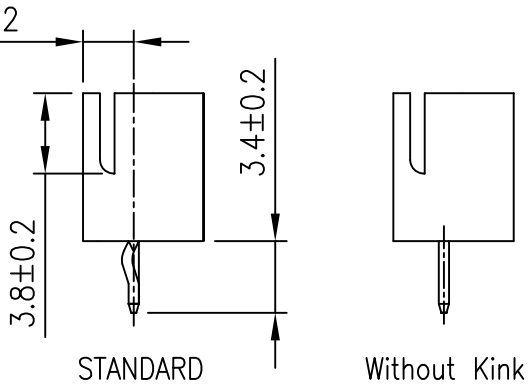
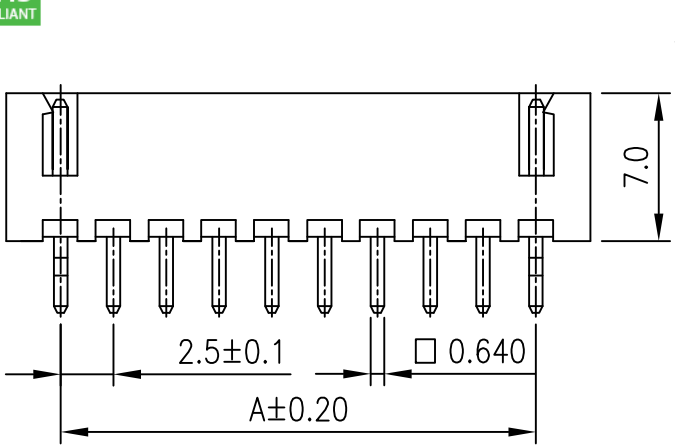

P.C.B. LAYOUT

Circuits	Dimension mm		Circuits	Dimension mm		Circuits	Dimension mm	
	A	B		A	B		A	B
2	2.50	7.50	9	20.00	25.00	16	37.50	42.50
3	5.00	10.00	10	22.50	27.50	17	40.00	45.00
4	7.50	12.50	11	25.00	30.00	18	42.50	47.50
5	10.00	15.00	12	27.50	32.50	19	45.00	50.00
6	12.50	17.50	13	30.00	35.00	20	47.50	52.50
7	15.00	20.00	14	32.50	37.50	--	--	--
8	17.50	22.50	15	35.00	40.00	--	--	--

TOLERANCE	
X.	--
X.X	±0.25
X.XX	±0.15
X.XXX	±0.05
ANGULAR	--
APPROVALS	
DRAWN	Frank 22-September-2009
CHECKED	Denise 22-September-2009
APPROVED	Jessica 22-September-2009



TITLE: 2.50mm(.098") Pitch
 Wire to Board Header

VIEW	SCALE	PART NO.	REV.
	3:1	YY-1300-W**S***-	A0
UNIT	SIZE	DWG NO.	SHEET
MM	A4	YY-1300-W**S***--014	1 OF 1





C **RI** US E182481

REV	DESCRIPTION	DATE

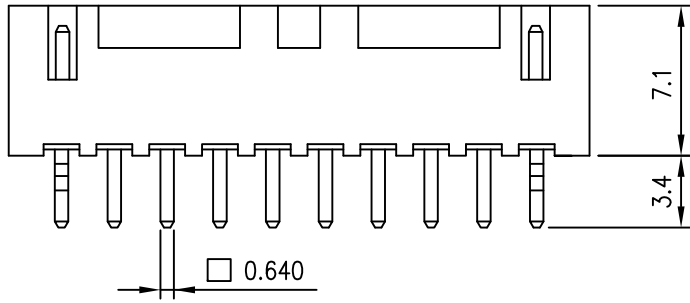
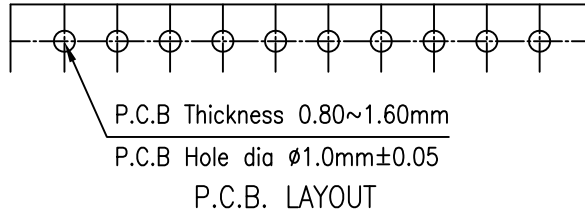
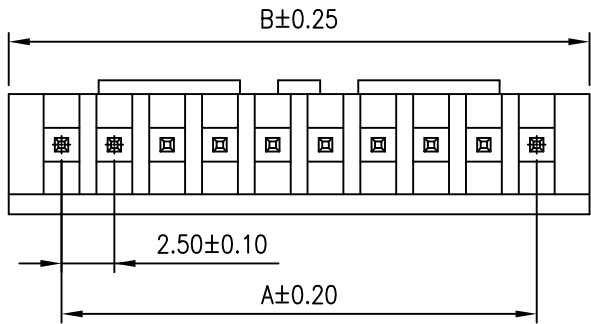

07~16Pin

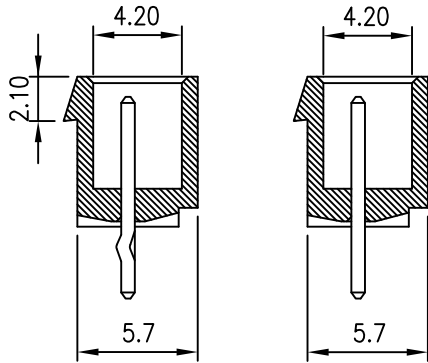

Standard

Without Kink

NOTES

Available in 02 through 16 Circuits
Material: Nylon 66 UL94-V0
Mates with YY-1300-H**L Series Housing
0.64mm(.025") Square Pin
Pin Material: Brass/Tin-Plated or Gold-Plated

ORDERING INFORMATION

YY-1300 - W **** S * L ***
 1 2 3 4 5

- 1. No. of Circuits 02~16
- 2. S : Straight
- 3. Plated
 T : Tin G : Gold
- 4. L : Lock
- 5. S : Without Kink
 □ : Standard(With Kink)

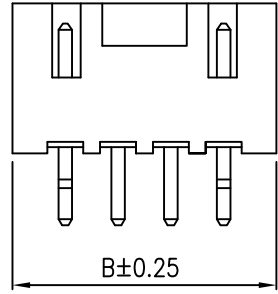

04~06Pin

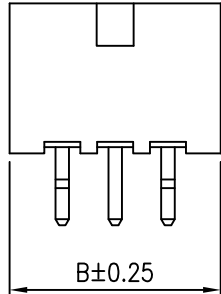

02~03Pin

Circuits	Dimension mm		Circuits	Dimension mm	
	A	B		A	B
2	2.50	7.50	10	22.50	27.50
3	5.00	10.00	11	25.00	30.00
4	7.50	12.50	12	27.50	32.50
5	10.00	15.00	13	30.00	35.00
6	12.50	17.50	14	32.50	37.50
7	15.00	20.00	15	35.00	40.00
8	17.50	22.50	16	37.50	42.50
9	20.00	25.00	--	--	--

TOLERANCE	
X.	--
X.X	±0.25
X.XX	±0.15
X.XXX	±0.05
ANGULAR	--
APPROVALS	
DRAWN	Frank 22-September-2009
CHECKED	Denise 22-September-2009
APPROVED	Jessica 22-September-2009



TITLE 2.50mm(.098") Pitch
Wire to Board Header

VIEW	SCALE	PART NO.	REV.
	3:1	YY-1300-W**S*L*	A0
UNIT	SIZE	DWG NO.	SHEET
MM	A4	YY-1300-W**S*L*-014	1 OF 1

