

HERMETIC TO-258 SCHOTTKY CENTER-TAP RECTIFIER

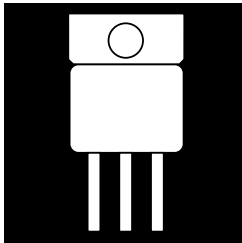

50 Amp, 45 To 100 Volt Schottky Rectifier

FEATURES

- Very Low Forward Voltage
- Fast Switching Speed
- Hermetic Metal Package, TO-258 Outline
- Low Thermal Resistance
- Isolated Package
- Available Screened To MIL-S-19500, TX, TXV And S Levels

DESCRIPTION

This product is specifically designed for use at power switching frequencies in excess of 100 kHz. The product combines two Schottky-barrier diodes in a center-tap configuration in a single package, simplifying installation, reducing heat sink hardware, and the need to obtain matched components. The device is ideally suited for Hi-Rel applications where small size and hermetically sealed package is required. Common anode configuration also available.

ABSOLUTE MAXIMUM RATINGS (T_C = 25° C) Per Diode

Peak Inverse Voltage	45, 60, 100 V
Maximum Average DC Output Current, Per Leg.....	25 A
Non-Repetitive Peak Surge Current (8.3 ms).....	400 A
Peak Reverse Transient Current	2 A
Storage Temperature Range	- 55° C to + 175° C
Junction Operating Temperature Range.....	- 55° C to + 150° C
Package Thermal Resistance, Junction-to-Case	1.7° C/W

3.2

SCHEMATIC

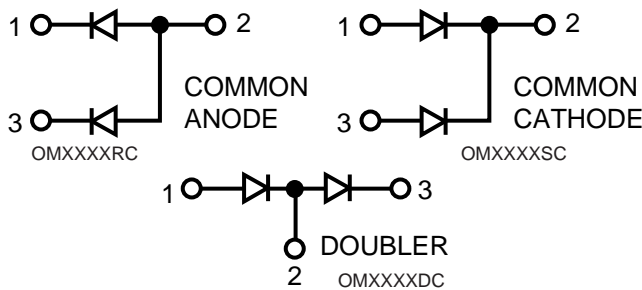

Common cathode is standard. Contact the factory for performance characteristics for common anode and doubler.
Z-Tab package also available.

PIN CONNECTION

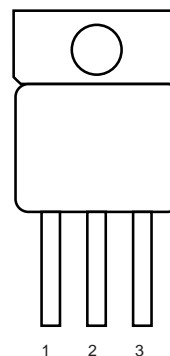

OM4213SC/RC/DC OM4219SC/RC/DC OM4220SC/RC/DC

ELECTRICAL CHARACTERISTICS (Per Diode)

Part No.	PIV	Maximum Forward Voltage @ $I_f = 25A^{(1)}$		Maximum Reverse Current	
		$T_c = 25^\circ C$	$T_c = 125^\circ C$	$T_c = 25^\circ C$	$T_c = 125^\circ C$
OM4213XX	45	.72 V	.64 V	2mA	40mA
OM4219XX	60	.80 V	.70 V		
OM4220XX	100	.90 V	.82 V		

(1) Pulse Test: Pulse Width 300 μ s, Duty Cycle 2.0%.

**TYPICAL FORWARD VOLTAGE
OM4213SC**

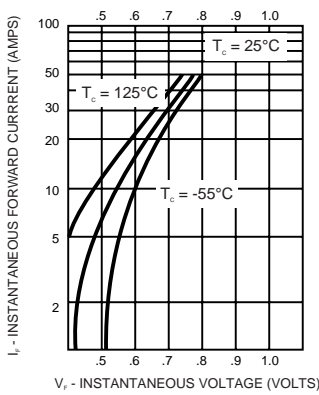

**TYPICAL FORWARD VOLTAGE
OM4219SC**

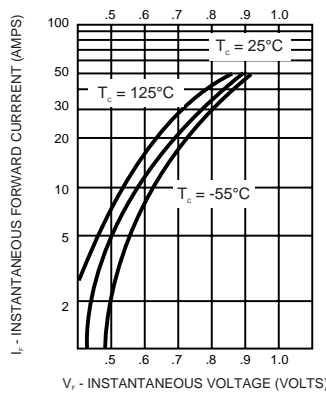

**TYPICAL FORWARD VOLTAGE
OM4220SC**

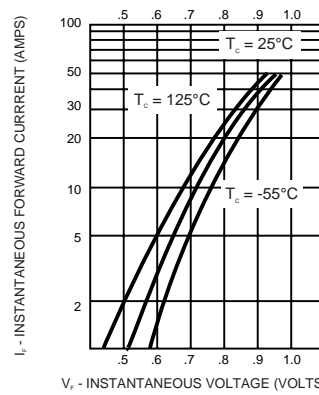

**TYPICAL REVERSE CURRENT
OM4213SC**

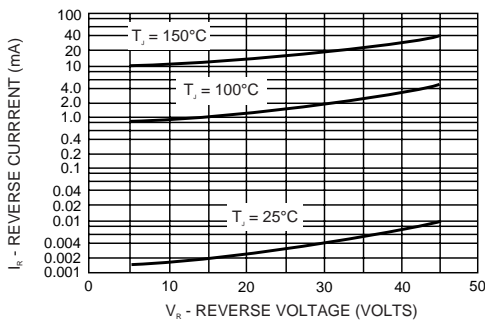

MECHANICAL OUTLINE

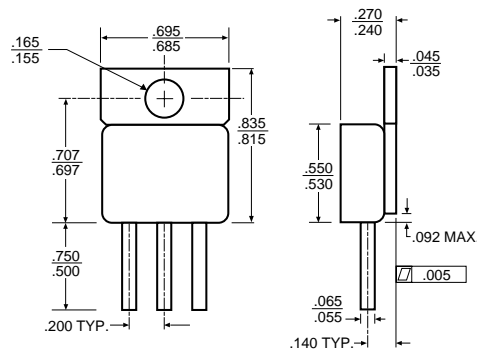

3.2