

SOT-26



Pin Definition:
 1. Drain 6. Drain
 2. Drain 5, Drain
 3. Gate 4. Source

PRODUCT SUMMARY

| V_{DS} (V) | $R_{DS(on)}$ (m Ω) | I_D (A) |
|--------------|----------------------------|-----------|
| -20 | 90 @ $V_{GS} = -4.5V$ | -3.3 |
| | 110 @ $V_{GS} = -2.5V$ | -2.9 |

Features

- Advance Trench Process Technology
- High Density Cell Design for Ultra Low On-resistance

Application

- Load Switch
- PA Switch

Ordering Information

| Part No. | Package | Packing |
|---------------|---------|-----------------|
| TSM3441CX6 RF | SOT-26 | 3Kpcs / 7" Reel |

Block Diagram

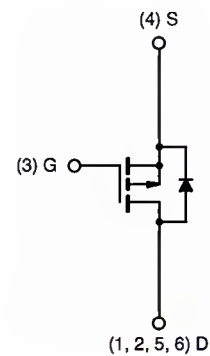

P-Channel MOSFET

Absolute Maximum Rating ($T_a = 25^\circ C$ unless otherwise noted)

| Parameter | Symbol | Limit | Unit |
|---|----------------|--------------------|------------|
| Drain-Source Voltage | V_{DS} | -20 | V |
| Gate-Source Voltage | V_{GS} | ± 8 | V |
| Continuous Drain Current, $V_{GS} @ 4.5V$. | I_D | -3.3 | A |
| Pulsed Drain Current, $V_{GS} @ 4.5V$ | I_{DM} | -10 | A |
| Continuous Source Current (Diode Conduction) ^{a,b} | I_S | -0.72 | A |
| Maximum Power Dissipation | P_D | $T_a = 25^\circ C$ | 1.25 |
| | | $T_a = 70^\circ C$ | 0.8 |
| Operating Junction Temperature | T_J | +150 | $^\circ C$ |
| Operating Junction and Storage Temperature Range | T_J, T_{STG} | - 55 to +150 | $^\circ C$ |

Thermal Performance

| Parameter | Symbol | Limit | Unit |
|--|-----------------|-------|--------------|
| Junction to Case Thermal Resistance | $R_{\theta JC}$ | 30 | $^\circ C/W$ |
| Junction to Ambient Thermal Resistance (PCB mounted) | $R_{\theta JA}$ | 80 | $^\circ C/W$ |

Notes:

- Pulse width limited by the Maximum junction temperature
- Surface Mounted on FR4 Board, $t \leq 5$ sec.

Electrical Specifications (Ta = 25°C unless otherwise noted)

| Parameter | Conditions | Symbol | Min | Typ | Max | Unit |
|---|--|--------------|-------|------|-----------|------------|
| Static | | | | | | |
| Drain-Source Breakdown Voltage | $V_{GS} = 0V, I_D = -250\mu A$ | BV_{DSS} | -20 | -- | -- | V |
| Gate Threshold Voltage | $V_{DS} = V_{GS}, I_D = -250\mu A$ | $V_{GS(TH)}$ | -0.45 | -- | -0.95 | V |
| Gate Body Leakage | $V_{GS} = \pm 8V, V_{DS} = 0V$ | I_{GSS} | -- | -- | ± 100 | nA |
| Zero Gate Voltage Drain Current | $V_{DS} = -16V, V_{GS} = 0V$ | I_{DSS} | -- | -- | -1.0 | μA |
| On-State Drain Current ^a | $V_{DS} \geq -10V, V_{GS} = -5V$ | $I_{D(ON)}$ | -6 | -- | -- | A |
| Drain-Source On-State Resistance ^a | $V_{GS} = -4.5V, I_D = -3.3A$ | $R_{DS(ON)}$ | -- | 75 | 90 | m Ω |
| | $V_{GS} = -2.5V, I_D = -2.9A$ | | -- | 90 | 110 | |
| Forward Transconductance ^a | $V_{DS} = -5V, I_D = -3.3A$ | g_{fs} | -- | 9 | -- | S |
| Diode Forward Voltage | $I_S = -1.6A, V_{GS} = 0V$ | V_{SD} | -- | -0.8 | -1.2 | V |
| Dynamic^b | | | | | | |
| Total Gate Charge | $V_{DS} = -6V, I_D = -2.8A,$ $V_{GS} = -4.5V$ | Q_g | -- | 5.8 | 10 | nC |
| Gate-Source Charge | | Q_{gs} | -- | 0.85 | -- | |
| Gate-Drain Charge | | Q_{gd} | -- | 1.7 | -- | |
| Input Capacitance | $V_{DS} = -6V, V_{GS} = 0V,$ $f = 1.0MHz$ | C_{iss} | -- | 415 | -- | pF |
| Output Capacitance | | C_{oss} | -- | 223 | -- | |
| Reverse Transfer Capacitance | | C_{rss} | -- | 87 | -- | |
| Switching^c | | | | | | |
| Turn-On Delay Time | $V_{DD} = -6V, R_L = 6\Omega,$ $I_D = -1A, V_{GEN} = -4.5V,$ $R_G = 6\Omega$ | $t_{d(on)}$ | -- | 13 | 25 | nS |
| Turn-On Rise Time | | t_r | -- | 36 | 60 | |
| Turn-Off Delay Time | | $t_{d(off)}$ | -- | 42 | 70 | |
| Turn-Off Fall Time | | t_f | -- | 34 | 60 | |

Notes:

- a. pulse test: PW $\leq 300\mu s$, duty cycle $\leq 2\%$
- b. For DESIGN AID ONLY, not subject to production testing.
- b. Switching time is essentially independent of operating temperature.

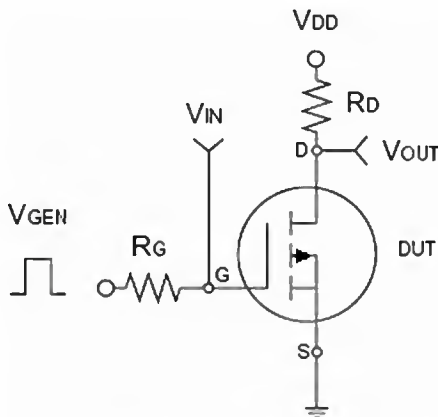

Switching Test Circuit

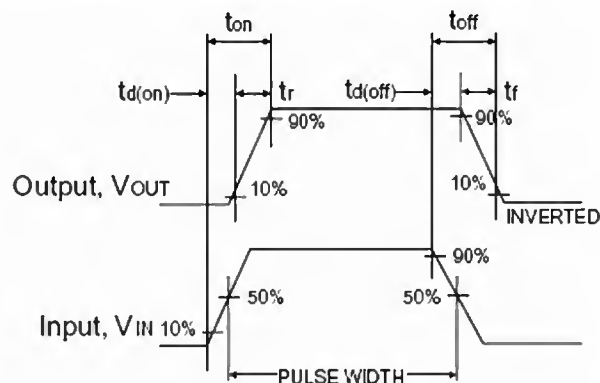

Switchin Waveforms

Electrical Characteristics Curve (Ta = 25°C, unless otherwise noted)

Output Characteristics

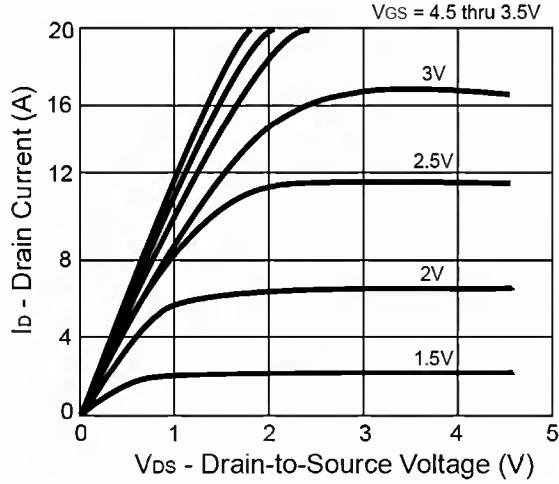

Transfer Characteristics

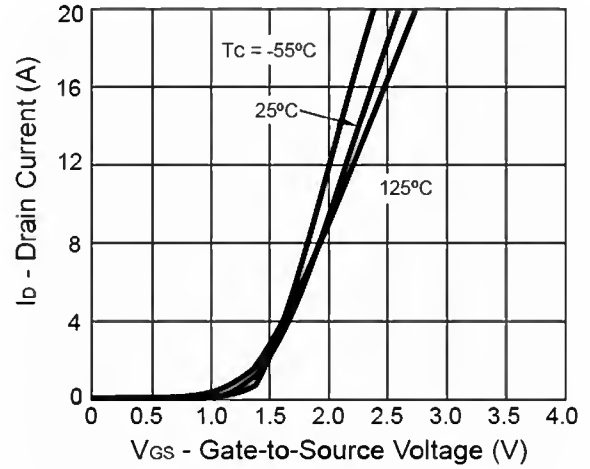

On-Resistance vs. Drain Current

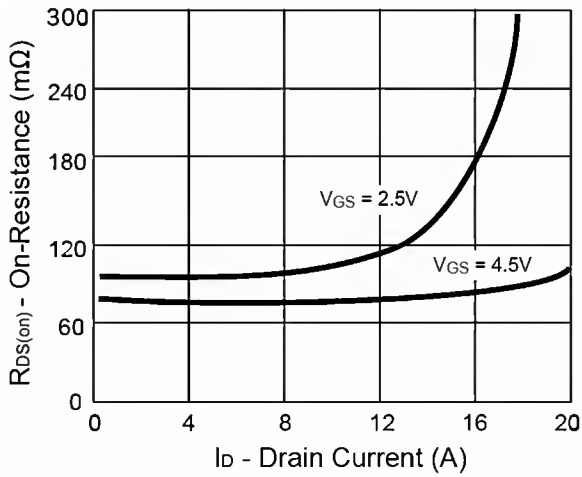

Gate Charge

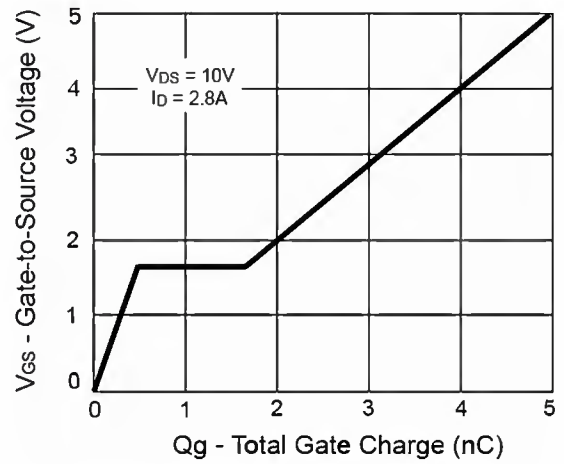

On-Resistance vs. Junction Temperature

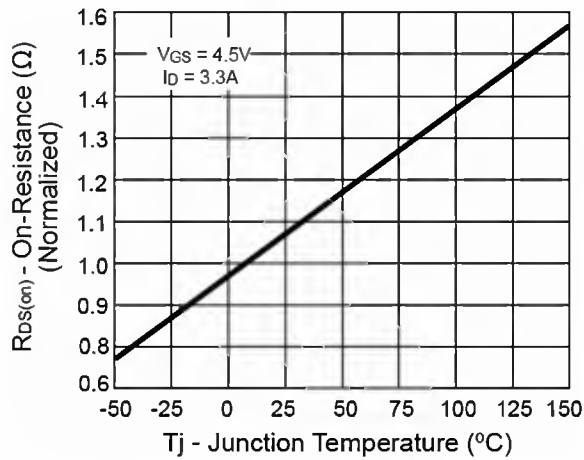

Source-Drain Diode Forward Voltage

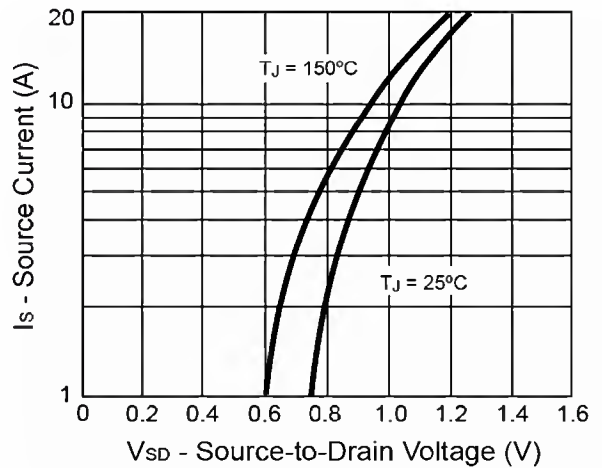

Electrical Characteristics Curve (Ta = 25°C, unless otherwise noted)

On-Resistance vs. Gate-Source Voltage

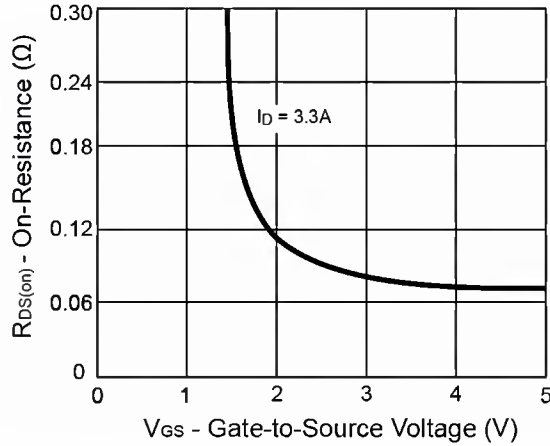

Threshold Voltage

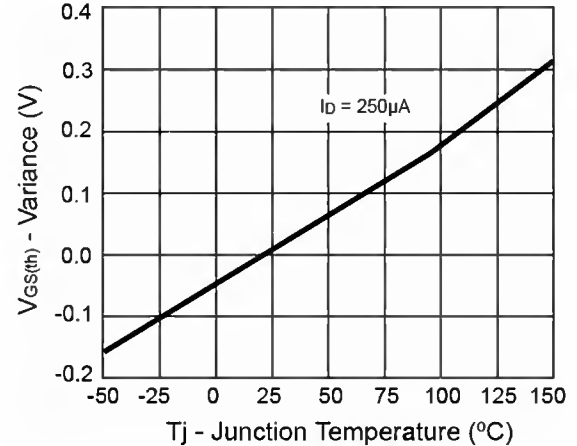

Single Pulse Power

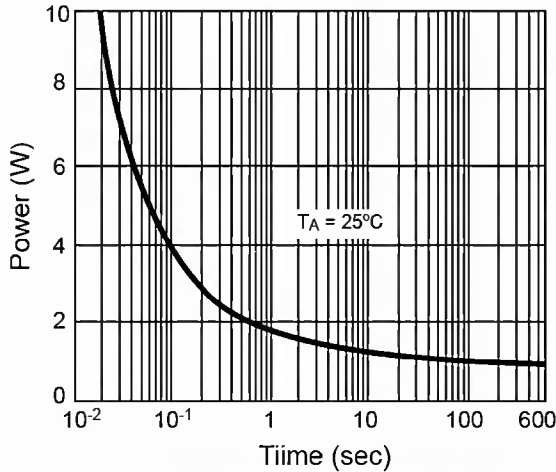

Normalized Thermal Transient Impedance, Junction-to-Ambient

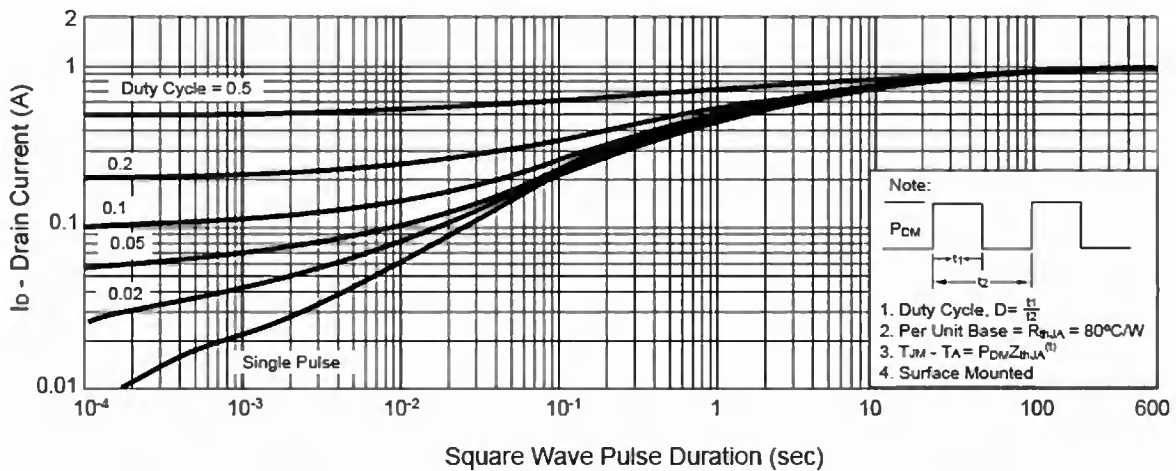

SOT-26 Mechanical Drawing

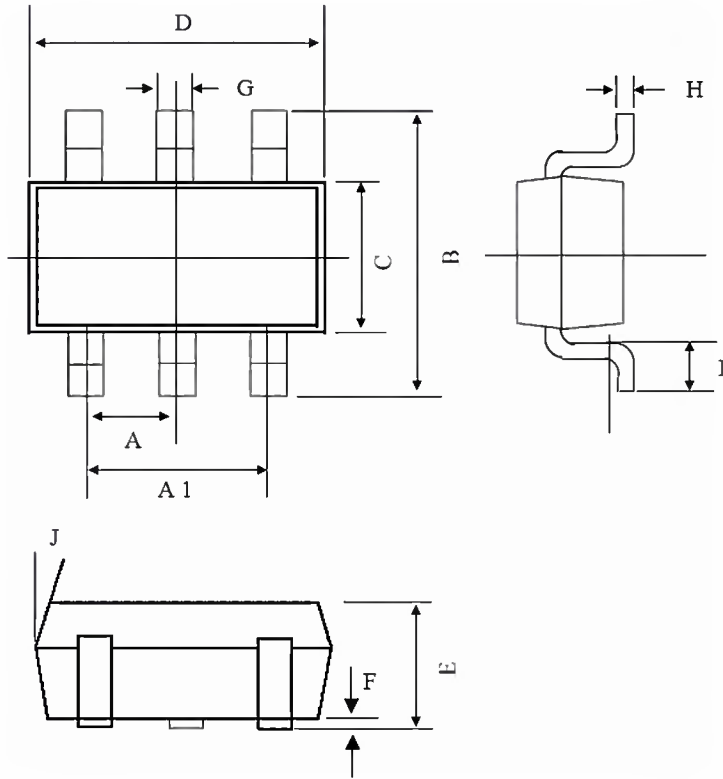

| SOT-26 DIMENSION | | | | | | |
|------------------|-------------|------|------|------------|--------|--------|
| DIM | MILLIMETERS | | | INCHES | | |
| | MIN | TYP | MAX | MIN | TYP | MAX |
| A | 0.95 BSC | | | 0.0374 BSC | | |
| A1 | 1.9 BSC | | | 0.0748 BSC | | |
| B | 2.60 | 2.80 | 3.00 | 0.1024 | 0.1102 | 0.1181 |
| C | 1.40 | 1.50 | 1.70 | 0.0551 | 0.0591 | 0.0669 |
| D | 2.80 | 2.90 | 3.10 | 0.1101 | 0.1142 | 0.1220 |
| E | 1.00 | 1.10 | 1.20 | 0.0394 | 0.0433 | 0.0472 |
| F | 0.00 | -- | 0.10 | 0.00 | | 0.0039 |
| G | 0.35 | 0.40 | 0.50 | 0.0138 | 0.0157 | 0.0197 |
| H | 0.10 | 0.15 | 0.20 | 0.0039 | 0.0059 | 0.0079 |
| I | 0.30 | -- | 0.60 | 0.0118 | -- | 0.0236 |
| J | 5° | -- | 10° | 5° | -- | 10° |

Marking Diagram

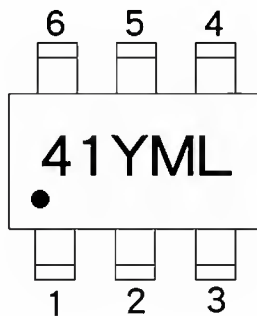

- 41** = Device Code
- Y** = Year Code
- M** = Month Code
- (**A**=Jan, **B**=Feb, **C**=Mar, **D**=Apr, **E**=May, **F**=Jun, **G**=Jul, **H**=Aug, **I**=Sep, **J**=Oct, **K**=Nov, **L**=Dec)
- L** = Lot Code

Notice

Specifications of the products displayed herein are subject to change without notice. TSC or anyone on its behalf, assumes no responsibility or liability for any errors or inaccuracies.

Information contained herein is intended to provide a product description only. No license, express or implied, to any intellectual property rights is granted by this document. Except as provided in TSC's terms and conditions of sale for such products, TSC assumes no liability whatsoever, and disclaims any express or implied warranty, relating to sale and/or use of TSC products including liability or warranties relating to fitness for a particular purpose, merchantability, or infringement of any patent, copyright, or other intellectual property right.

The products shown herein are not designed for use in medical, life-saving, or life-sustaining applications. Customers using or selling these products for use in such applications do so at their own risk and agree to fully indemnify TSC for any damages resulting from such improper use or sale.