

P-Channel Enhancement Mode Power MOSFET

■ Features

- Simple Gate Drive
- Fast Switching Speed
- Small Package Outline (SOT323)

■ Description

The advanced power MOSFET provides the designer with the best combination of fast switching, low on-resistance and cost-effectiveness.

■ Product Summary

$BV_{DSS} = -20V$
 $R_{DS(on)} = 800m\Omega$
 $I_D = -550mA$

■ Pin Assignments

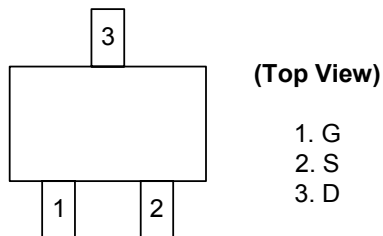

■ Pin Descriptions

Pin No.	Pin Name	Description
1	G	Gate
2	S	Source
3	D	Drain

■ Ordering information

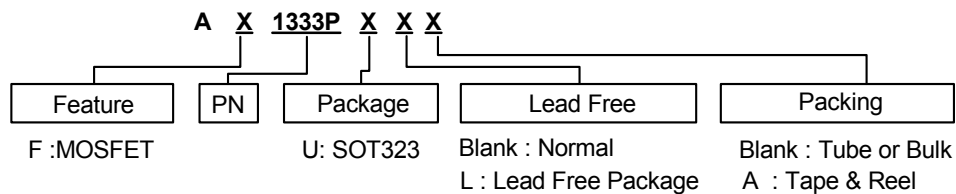

■ Block Diagram

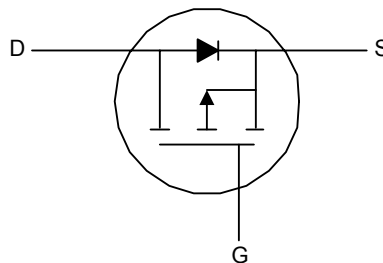



P-Channel Enhancement Mode Power MOSFET

■ Absolute Maximum Ratings

Symbol	Parameter	Rating	Unit
V_{DS}	Drain-Source Voltage	-20	V
V_{GS}	Gate-Source Voltage	± 12	V
I_D	Continuous Drain Current (Note 1)	$T_A=25^\circ\text{C}$	-550
		$T_A=70^\circ\text{C}$	-440
I_{DM}	Pulsed Drain Current (Note 2, 3)	-2.5	A
P_D	Total Power Dissipation	$T_A=25^\circ\text{C}$	0.35
	Linear Derating Factor		0.003
T_{STG}	Storage Temperature Range	-55 to +150	$^\circ\text{C}$
T_J	Operating Junction Temperature Range	-55 to +150	$^\circ\text{C}$

■ Thermal Data

Symbol	Parameter	Value	Unit
Rthj-a	Thermal Resistance Junction-Ambient (Note 1)	Max. 360	$^\circ\text{C/W}$

■ Electrical Characteristics at $T_A=25^\circ\text{C}$ (unless otherwise specified)

Symbol	Parameter	Test Conditions	Min.	Typ.	Max.	Unit
BV_{DSS}	Drain-Source Breakdown Voltage	$V_{GS}=0\text{V}, I_D=-250\mu\text{A}$	-20	-	-	V
$\Delta BV_{DSS} / \Delta T_J$	Breakdown Voltage Temperature Coefficient	Reference to 25°C , $I_D=-1\text{mA}$	-	0.01	-	$\text{V}/^\circ\text{C}$
$R_{DS(ON)}$	Static Drain-Source On-Resistance	$V_{GS}=-10\text{V}, I_D=-550\text{mA}$	-	-	600	m Ω
		$V_{GS}=-4.5\text{V}, I_D=-550\text{mA}$	-	-	800	
		$V_{GS}=-2.5\text{V}, I_D=-300\text{mA}$	-	-	1000	
$V_{GS(th)}$	Gate Threshold Voltage	$V_{DS}=V_{GS}, I_D=-250\mu\text{A}$	-0.5	-	-1.2	V
g_{fs}	Forward Transconductance	$V_{DS}=-5\text{V}, I_D=-500\text{mA}$	-	1	-	S
I_{DSS}	Drain-Source Leakage Current ($T_J=25^\circ\text{C}$)	$V_{DS}=-20\text{V}, V_{GS}=0\text{V}$	-	-	-1	μA
	Drain-Source Leakage Current ($T_J=70^\circ\text{C}$)	$V_{DS}=-16\text{V}, V_{GS}=0\text{V}$	-	-	-10	
I_{GSS}	Gate-Source Leakage	$V_{GS}=\pm 12\text{V}$	-	-	± 100	nA
Q_g	Total Gate Charge (Note 3)	$I_D=-500\text{mA}$,	-	1.7	2.7	nC
Q_{gs}	Gate-Source Charge	$V_{DS}=-16\text{V}$,	-	0.3	-	
Q_{gd}	Gate-Drain ("Miller") Charge	$V_{GS}=-4.5\text{V}$	-	0.4	-	
$t_{d(on)}$	Turn-On Delay Time (Note 3)	$V_{DS}=-10\text{V}$,	-	5	-	ns
t_r	Rise Time	$I_D=-500\text{mA}$,	-	8	-	
$t_{d(off)}$	Turn-Off Delay Time	$R_G=3.3\Omega, V_{GS}=-5\text{V}$	-	10	-	
t_f	Fall-Time	$R_D=20\Omega$	-	2	-	
C_{iss}	Input Capacitance	$V_{GS}=0\text{V}$,	-	66	105.6	pF
C_{oss}	Output Capacitance	$V_{DS}=-10\text{V}$,	-	25	-	
C_{rss}	Reverse Transfer Capacitance	$f=1.0\text{MHz}$	-	20	-	

■ Source-Drain Diode

Symbol	Parameter	Test Conditions	Min.	Typ.	Max.	Unit
V_{DS}	Forward On Voltage (Note 3)	$I_S=-300\text{mA}, V_{GS}=0\text{V}$	-	-	-1.2	V

Note 1: Surface mounted on FR4 board, $t \leq 10$ sec.

Note 2: Pulse width limited by Max. junction temperature.

Note 3: Pulse width $\leq 300\mu\text{s}$, duty cycle $\leq 2\%$.

P-Channel Enhancement Mode Power MOSFET

■ Typical Performance Characteristics

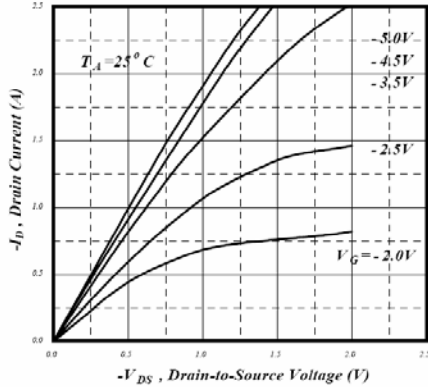

Fig 1. Typical Output Characteristics

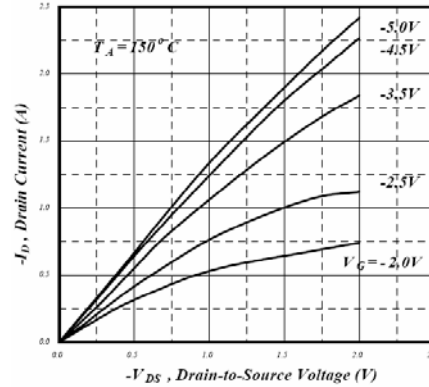

Fig 2. Typical Output Characteristics

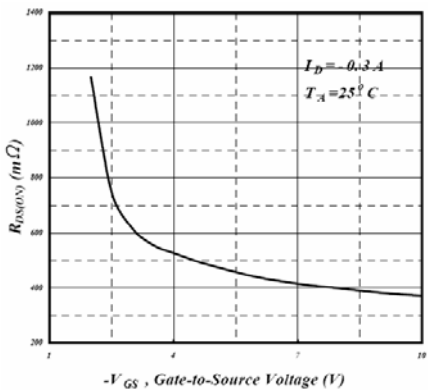

Fig 3. On-Resistance v.s. Gate Voltage

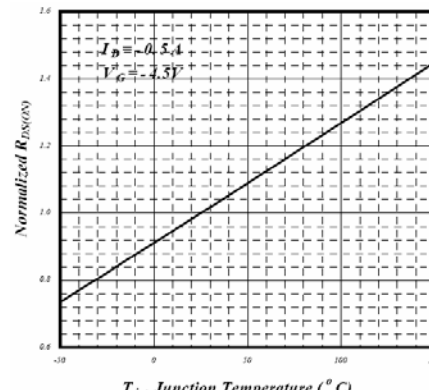

Fig 4. Normalized On-Resistance v.s. Junction Temperature

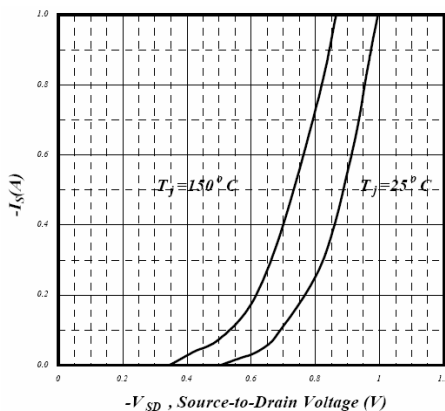

Fig 5. Forward Characteristic of Reverse Diode

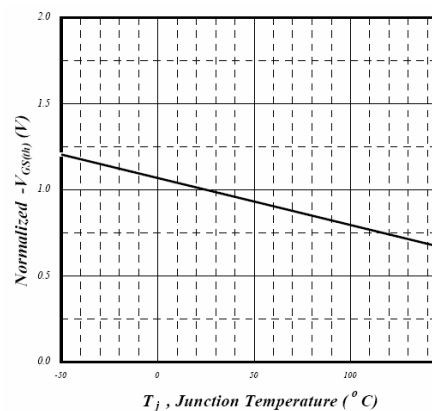

Fig 6. Gate Threshold Voltage v.s. Junction Temperature

P-Channel Enhancement Mode Power MOSFET

■ Typical Performance Characteristics (Continued)

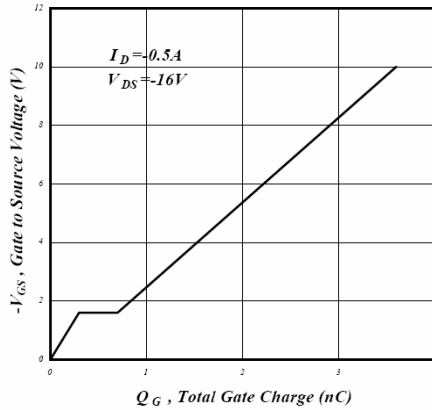

Fig 7. Gate Charge Characteristics

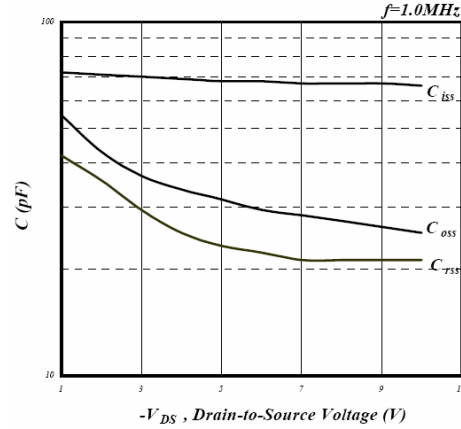

Fig 8. Typical capacitance Characteristics

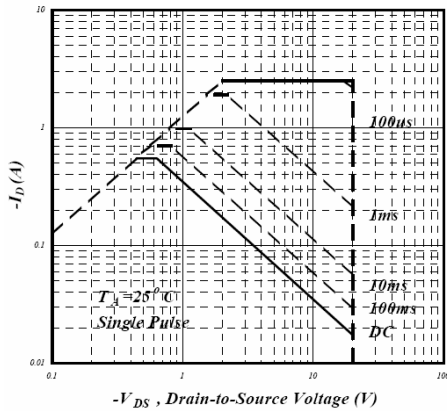

Fig 9. Maximum Safe Operating Area

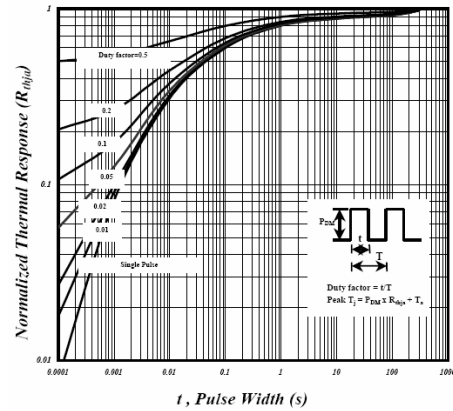

Fig 10. Effective Transient Thermal Impedance

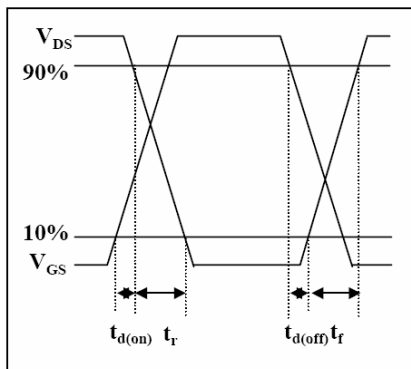

Fig 11. Switching Time Waveform

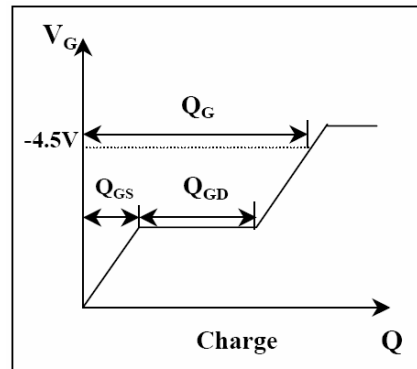
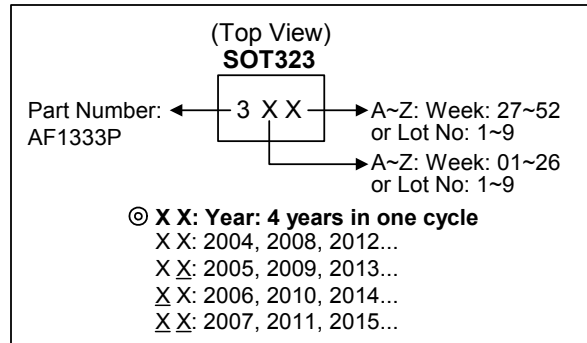

Fig 12. Gate Charge Waveform

P-Channel Enhancement Mode Power MOSFET

■ Marking Information



■ Package Information

Package Type: SOT323

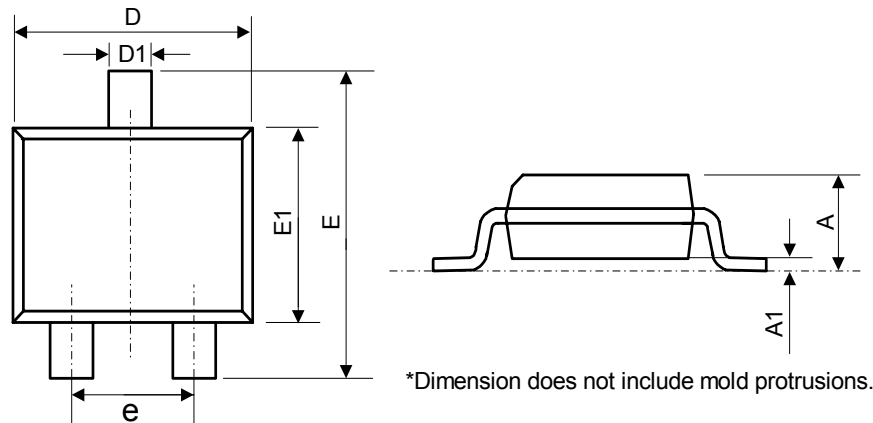

Symbol	Dimensions In Millimeters			Dimensions In Inches		
	Min.	Nom.	Max.	Min.	Nom.	Max.
A	0.90	1.00	1.10	0.035	0.039	0.043
A1	0.03	0.07	0.10	0.001	0.003	0.004
D	1.90	2.00	2.10	0.075	0.079	0.083
D1	0.20	0.30	0.40	0.008	0.012	0.016
E	2.00	2.10	2.20	0.079	0.083	0.087
E1	1.15	1.25	1.35	0.045	0.049	0.053
e	1.30 Bsc.			0.051 Bsc.		