

RECTIFIERS

High Efficiency, 8A

SES5401-SES5404

FEATURES

- Low Forward Voltage
- Fast Recovery Times
- Economical, Convenient TO-220 Package
- Low Thermal Resistance
- Mechanically Rugged
- PIV up to 200V

DESCRIPTION

The SES5401 Series, in the economical, convenient TO-220 package, is specifically designed for operation in power switching circuits to frequencies in excess of 100kHz. The very low forward voltage and very fast recovery time make them particularly suited for switching type power supplies.

ABSOLUTE MAXIMUM RATINGS

Peak Inverse Voltage, SES5401	50V
Peak Inverse Voltage, SES5402	100V
Peak Inverse Voltage, SES5403	150V
Peak Inverse Voltage, SES5404	200V
Maximum Average D.C. Output Current	
@ $T_C = 125^\circ\text{C}$	8.0A
@ $T_A = 25^\circ\text{C}$	3.0A
@ $T_A = 25^\circ\text{C}$ (Note 1)	8.0A
Non-Repetitive Sinusoidal Surge Current, 8.3ms	70A
Thermal Resistance, Junction to Case, θ_{JC}	2.5°C/W
Thermal Resistance, Junction to Ambient, θ_{JA}	60°C/W
Operating and Storage Temperature Range	-55°C to +150°C

NOTE 1. Using Wakefield Type 295 heatsink with convection cooling. For more definitive data refer to the Output Current vs. Temperature Curves on this datasheet.

ELECTRICAL SPECIFICATIONS

Type	PIV	Maximum Forward Voltage (V_F) @		Maximum Reverse Current (I_R) @ PIV		Maximum Reverse Recovery Time*	Typical Forward Recovery Voltage @ 1A $t_r = 8\text{ns}$
		$T_J = 25^\circ\text{C}$	$T_J = 100^\circ\text{C}$	@ $T_J = 25^\circ\text{C}$	@ $T_J = 100^\circ\text{C}$		
SES5401	50V	1.025V @ 8A	0.945V @ 8A	5 μA	150 μA	100ns	1.4V
SES5402	100V				150 μA		
SES5403	150V				150 μA		
SES5404	200V				500 μA		

*Measured in circuit $I_F = 0.50\text{A}$, $I_R = 1.0\text{A}$, $I_{\text{REC}} = 0.25\text{A}$

MECHANICAL SPECIFICATIONS

SEATING PLANE

SECT 4-A

PIN 1. Cathode
2. Anode
Tab is connected to Cathode.

SES5401-SES5404

	INCHES		MILLIMETERS	
	MIN	MAX	MIN	MAX
A	0.560	0.625	14.23	15.87
B	0.380	0.420	9.66	10.66
C	0.140	0.190	3.56	4.82
D	0.020	0.045	0.51	1.14
F	0.139	0.147	3.531	3.733
G	0.090	0.110	2.29	2.79
H	-	0.250	-	6.35
J	0.015	0.025	0.38	0.64
K	0.500	0.562	12.70	14.27
L	0.045	0.070	1.14	1.77
N	0.190	0.210	4.83	5.33
Q	0.100	0.120	2.54	3.04
R	0.080	0.115	2.04	2.92
S	0.045	0.055	1.14	1.39
T	0.230	0.270	5.85	6.85

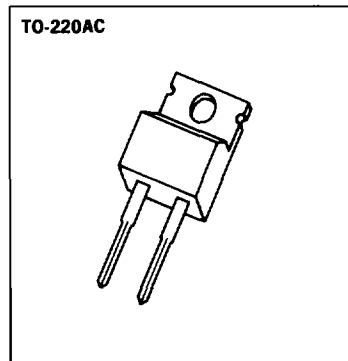

Output Current vs. Temperature

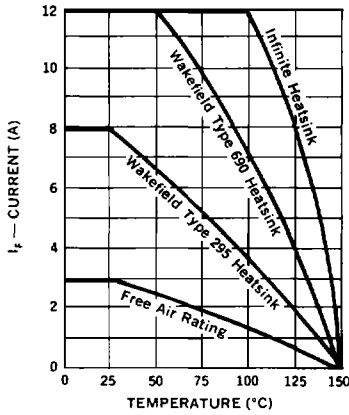

Typical Forward Current vs. Forward Voltage

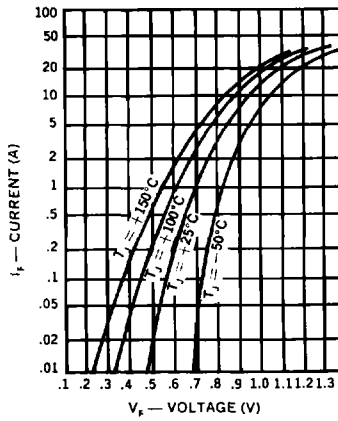

Typical Reverse Current vs. Voltage

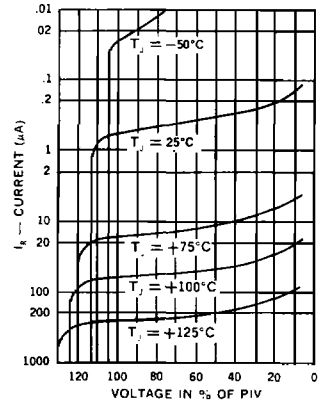

4

Forward Pulse Current vs. Duration

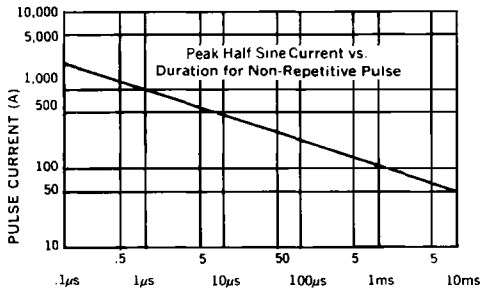

Multiple Surge Current vs. Duration

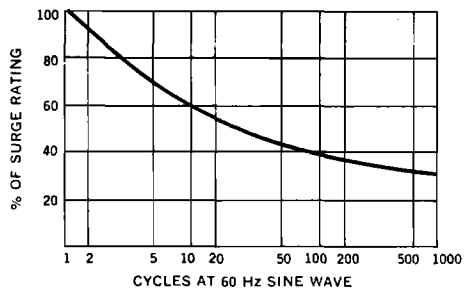

Thermal Impedance vs. Pulse Width

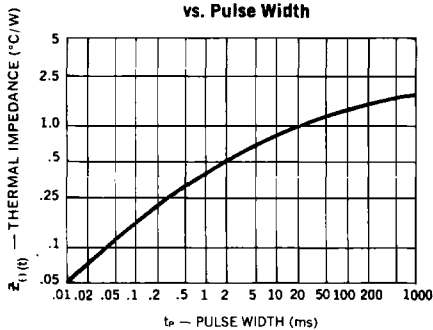

Reverse-Recovery Circuit

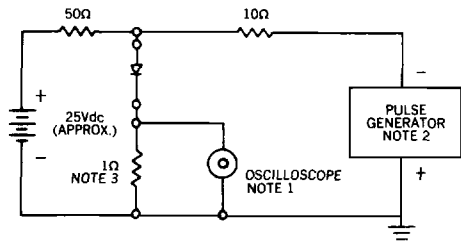

- NOTES:**
1. Oscilloscope: Rise time $\leq 3\text{ns}$; input impedance = 50Ω.
 2. Pulse Generator: Rise time $\leq 8\text{ns}$; source impedance 100Ω.
 3. Current viewing resistor, non-inductive, coaxial recommended.