

8Kx8 Static RAM CMOS, Low Power Monolithic

PRELIMINARY

The EDI8810H/L is a 65,653bit, 6 transistor cell CMOS Static RAM organized as 8Kx8.

It is available in both standard (H) and low power (L) versions. Both versions offer battery back-up data retention capability at VDD equal to 2V and 3V.

In addition to 13 address inputs, and 8 common data inputs and outputs, the device contains 4 control lines. The E1 and E2 lines perform chip enable functions and automatically power-down the device when proper logic levels are applied. The G and W lines facilitate read and write operations.

All inputs and outputs are TTL compatible and operate from a single 5V supply.

Military product compliant to MIL-STD-883, Paragraph 1.2.1 is available.

Pin Configurations and Block Diagram

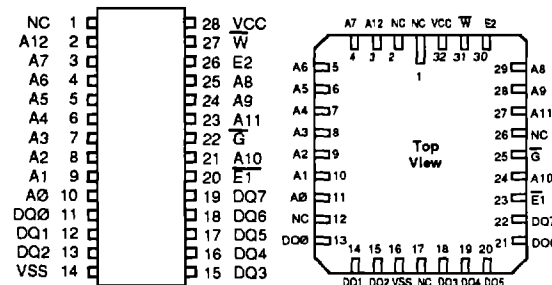

Pin Names

A0-A12	Address Inputs
E1, E2	Chip Enables
W	Write Enable
G	Output Enable
DQ0-DQ7	Common Data Input/Output
VCC	Power (+5V±10%)
VSS	Ground
NC	No Connection

Features

8Kx8 bit CMOS Static

Random Access Memory

- Access Times 55 through 150ns
- E and G Functions for Bus Control
- Data Retention Function
- TTL Compatible Inputs and Outputs

Jedec Approved Pinouts

- 28 Pin CERDIP, 600 mils wide, No. 70
- 32 Pad Ceramic LCC, No. 12

Single +5V (±10%) Supply Operation

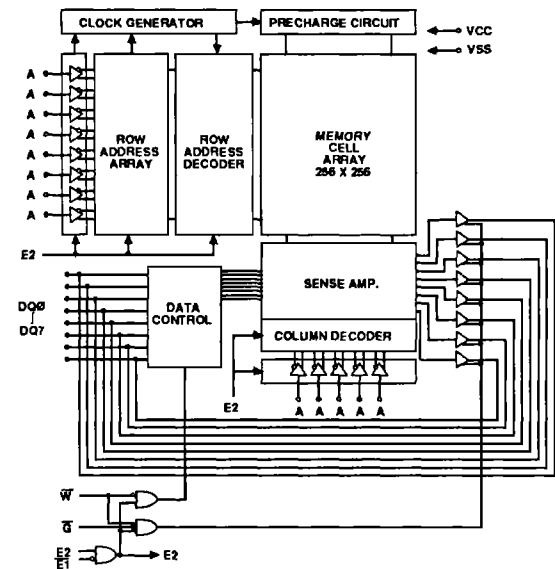

Absolute Maximum Ratings*

Voltage on any pin relative to VSS -0.5V to 8.0V
 Operating Temperature TA (Ambient)
 Industrial -40°C to +85°C
 Military -55°C to +125°C
 Storage Temperature, Ceramic -65°C to +150°C
 Power Dissipation 1 Watt
 Output Current 20 mA
 Junction Temperature, TJ 175°C

*Stress greater than those listed under "Absolute Maximum Ratings" may cause permanent damage to the device. This is a stress rating only and functional operation of the device at these or any other conditions greater than those indicated in the operational sections of this specification is not implied. Exposure to absolute maximum rating conditions for extended periods may affect reliability.

Recommended DC Operating Conditions

Parameter	Sym	Min	Typ	Max	Units
Supply Voltage	VCC	4.5	5.0	5.5	V
Supply Voltage	VSS	0	0	0	V
Input High Voltage	VIH	2.2	--	6.0	V
Input Low Voltage	VIL	-0.5	--	0.8	V

AC Test Conditions

Input Pulse Levels VSS to 3.0V
 Input Rise and Fall Times 5ns
 Input and Output Timing Levels 1.5V
 Output Load.: 1TTL, CL = 100pF
 (note: For TEHQZ, TGHQZ and TWLQZ, CL = 5pF)

DC Electrical Characteristics

Parameter	Sym	Conditions	Min	Typ*	Max	Units	
Operating Power Supply Current	ICC1	$\bar{W}, \bar{E}1 = VIL, I/O = 0mA, \text{Min Cycle}; E2 = VIH$	--	45	70	mA	
Standby (TTL) Power Supply Current	ICC2	$\bar{E}1 \geq VIH \text{ or } E2 \leq VIL$	--	--	2	mA	
Full Standby Power Supply Current	ICC3	$\bar{E}1 \geq VCC-0.2V \text{ or } E2 \leq 0.2V$	H	--	1	500	μA
		$VIN \geq VCC-0.2V \text{ or } VIN \leq 0.2V$	L	--	0.2	100	μA
Input Leakage Current	ILI	$VIN = 0V \text{ to } VCC$	--	--	± 5	μA	
Output Leakage Current	ILO	$V I/O = 0V \text{ to } VCC$	--	--	± 5	μA	
Output High Voltage	VOH	$IOH = -1.0mA$	2.4	--	--	V	
Output Low Voltage	VOL	$IOL = 4.0mA$	--	--	0.4	V	

*Typical = TA = 25°C, VCC = 5.0V

Truth Table

\bar{G}	$\bar{E}1$	E2	\bar{W}	Mode	Output	Power
X	H	X	X	Standby	High Z	ICC2, ICC3
X	X	L	X	Standby	High Z	ICC2, ICC3
H	L	H	H	Output Deselect	High Z	ICC1
L	L	H	H	Read	DOU	ICC1
X	L	H	L	Write	DIN	ICC1

Capacitance

(f=1.0MHz, VIN=VCC or VSS)

Parameter	Sym	Max		Unit
		LCC	DIP	
Input Capacitance (Except DQ Pins)	CI	6	10	pF
Capacitance Control (DQ Pins)	CD/Q	8	12	pF

These parameters are sampled, not 100% tested.

AC Characteristics
Read Cycle

Parameter	Symbol	55ns		70ns		85ns		100ns		120ns		150ns		Unit
		Min	Max	Min	Max	Min	Max	Min	Max	Min	Max	Min	Max	
Read Cycle Time	TAVAV	55		70		85		100		120		150		ns
Address Access Time	TAVQV		55		70		85		100		120		150	ns
Chip Enable Access Time	TE1LQV		55		70		85		100		120		150	ns
	TE2HQV		55		70		85		100		120		150	ns
Chip Enable to Output in Low Z (1)	TE1LOX	5		5		5		10		10		10		ns
	TE2HOX	5		5		5		10		10		10		ns
Output Enable to Output Valid	TGLQV		25		35		45		45		50		50	ns
Output Enable to Output in Low Z (1)	TGLQX	0		0		0		0		0		0		ns
Chip Disable to Output in High Z (1)	TE1HQZ	0	25	0	35	0	40	0	40	0	40	0	40	ns
	TE2LQZ	0	25	0	35	0	40	0	40	0	40	0	40	ns
Output Disable to Output in High Z (1)	TGHQZ		30		35		40		40		40		40	ns
Output Hold from Address Change	TAVQX	10		10		10		10		10		10		ns

Note 1: Parameter guaranteed, but not tested.

Read Cycle 1
W, E2 High; G, E1 Controlled

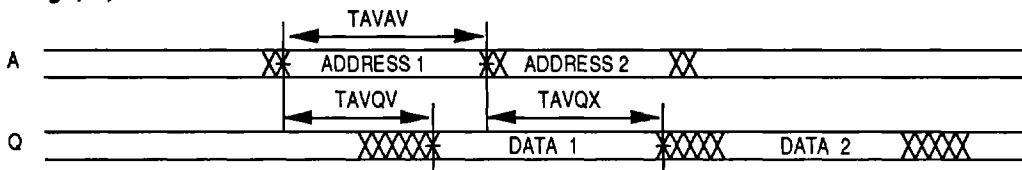

Read Cycle 2
W High

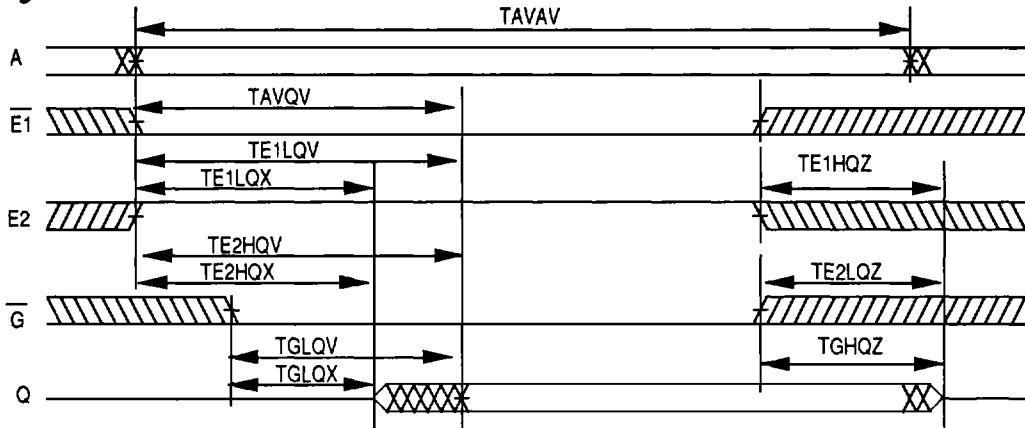

AC Characteristics

Write Cycle

Parameter	Symbol	55ns		70ns		85ns		100ns		120ns		150ns		Unit
		Min	Max	Min	Max	Min	Max	Min	Max	Min	Max	Min	Max	
Write Cycle Time	TAVAV	55		70		85		100		120		150		ns
Chip Enable to End of Write	TE1LWH	$\overline{E1}$	40		50		65		65		65		65	ns
	TE2HWH	E2	40		50		65		65		65		65	ns
Address Setup Time	TAVWL	\overline{W}	0		0		0		0		0		0	ns
	TAVE1L	$\overline{E1}$	0		0		0		0		0		0	ns
	TAVE2H	E2	0		0		0		0		0		0	ns
Address Valid to End of Write	TAVWH		40		50		65		65		65		65	ns
Write Pulse Width	TWLWH	\overline{W}	35		40		45		45		45		45	ns
	TE1LE1H	$\overline{E1}$	35		40		45		45		45		45	ns
	TE2HE2L	E2	35		40		45		45		45		45	ns
Write Recovery Time	TWHAX	\overline{W}	0		0		0		0		0		0	ns
	TE1HAX	$\overline{E1}$	0		0		0		0		0		0	ns
	TE2LAX	E2	0		0		0		0		0		0	ns
Data Hold Time	TWHDX	\overline{W}	5		5		5		5		5		5	ns
	TE1HDX	$\overline{E1}$	5		5		5		5		5		5	ns
	TE2LDX	E2	5		5		5		5		5		5	ns
Write to Output in High Z (1)	TWLQZ		20		25		30		30		30		30	ns
Data to Write Time	TDVWH	\overline{W}	25		30		35		35		35		35	ns
	TDVE1H	$\overline{E1}$	25		30		35		35		35		35	ns
	TDVE2L	E2	25		30		35		35		35		35	ns
Output Active from End of Write (1)	TWHQX		5		5		5		5		5		5	ns

Note 1: Parameter guaranteed, but not tested.

Write Cycle 1
Late Write, \overline{W} Controlled

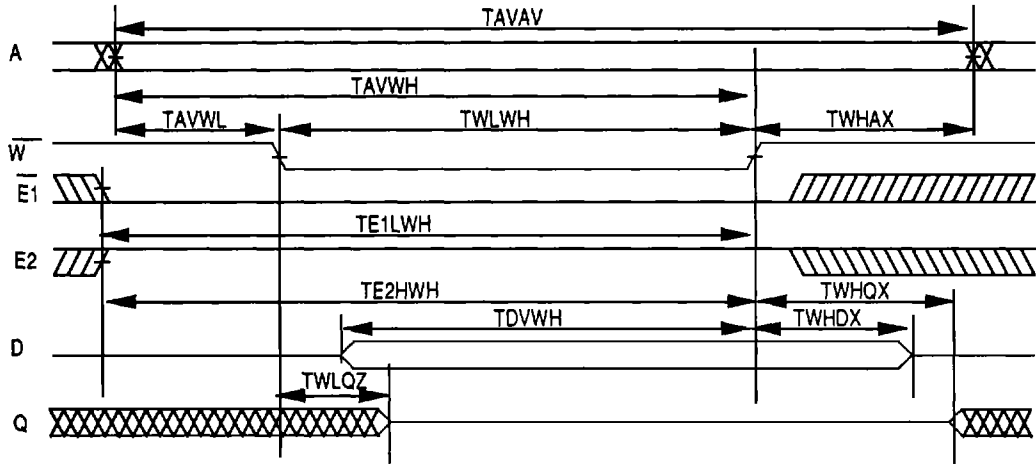

Write Cycle 2
Early Write, $\overline{E1}$ Controlled

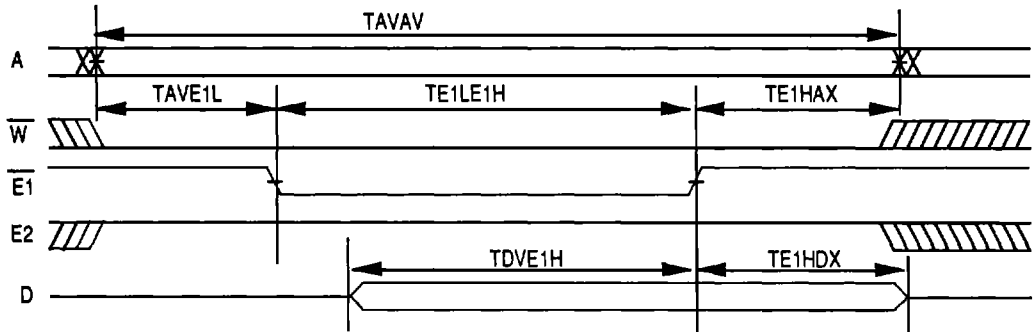

Write Cycle 3
Early Write, $\overline{E2}$ Controlled

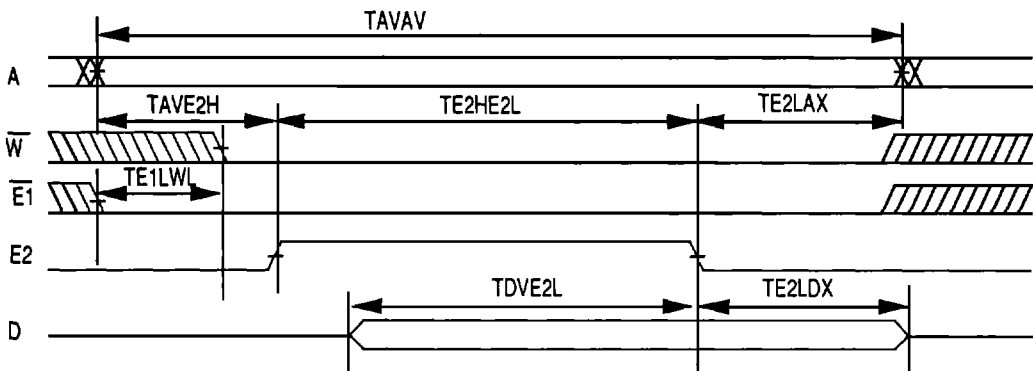

Data Retention Characteristics

Characteristic	Sym	Test Conditions	VDD	Min	Typ	Max		Unit
						H	L	
Data Retention Voltage	VDD	$\bar{E}1 \geq VDD - 0.2V$			2	--	--	V
Data Retention Quiescent Current	ICCDR	$E2 \leq 0.2V$ $VIN \geq VDD - 0.2V$	2V	--	0.1	200	50	μA
			3V	--	0.3	300	75	μA
Chip Disable to Data Retention Time	TCDR	$or\ VIN \leq 0.2V$		0	--	--	--	ns
Operation Recovery Time	TR		TAVAV*	--	--	--	--	ns

*Read Cycle Time

Data Retention E1 Controlled

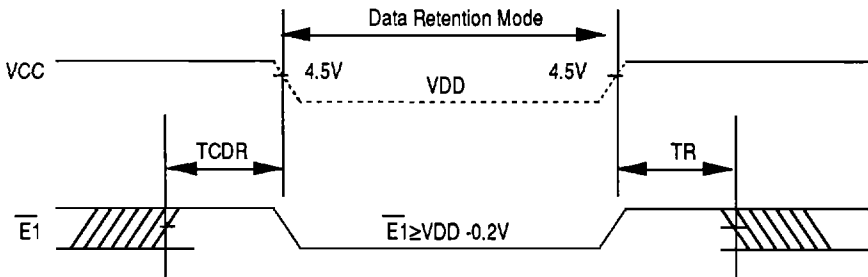

Data Retention E2 Controlled

