

### Mini Jumper 2.0mm

#### Specifications

Current Rate: 2 AMP  
 Insulation Resistance: 1000MΩ Min.  
 Contact Resistance: 20mΩ Max.  
 Dielectric Voltage: 500V AC for one minute  
 Operation Temperature: -40°C to +105°C

#### Material

Insulator: Polyester, UL 94V-0  
 ©Standard: PBT or Nylon 66  
 Terminal: Copper Alloy  
 Plating: Gold Plated

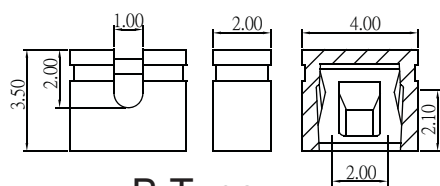
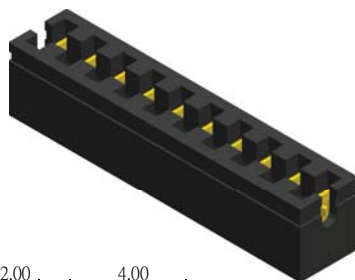

B Type

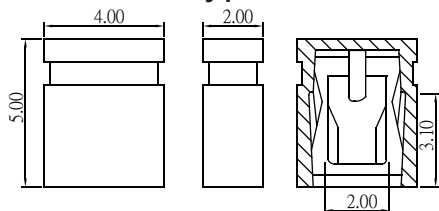

C Type

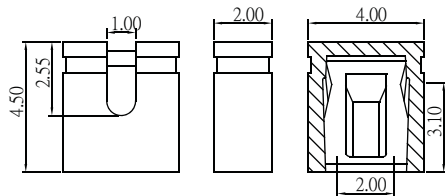

D Type

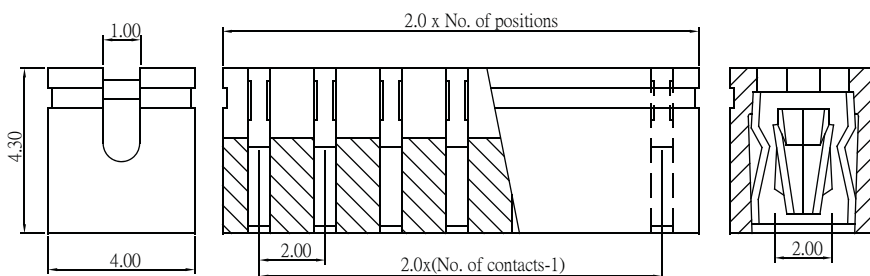

E Type

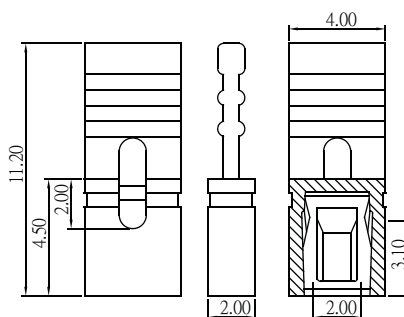

F Type

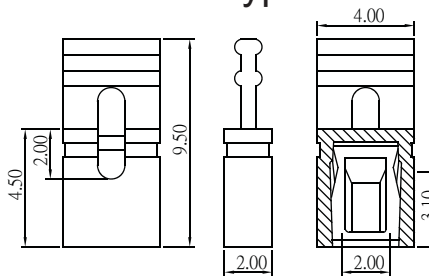

G Type

### ORDER INFORMATION

