

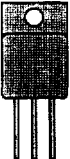

## The NOVA Program — Power MOSFETS

Package	Part Number	BV <sub>DSS</sub> (volts)	R <sub>DS(ON)</sub> @ I <sub>D</sub> (A) (ohms)	I <sub>D</sub> cont. (amps)	P <sub>D</sub> (watts)	Die
	SNF130	100	0.18 @ 7.0	11.0	45	IRFC130
	SNF140	100	0.077 @ 16	16.0	100	IRFC140
	SNF240	200	0.18 @ 16	16.0	100	IRFC240
	SNF340	400	0.55 @ 5.5	8.7	100	IRFC340
	SNF1423	500	0.85 @ 7.0	7.0	100	IRFC440
	P-Channel SPFY9140	-100	0.20 @ 8.2	-13.0	60	IRFC9140

Package	Part Number	BV <sub>DSS</sub> (volts)	R <sub>DS(ON)</sub> @ I <sub>D</sub> (A) (ohms)	I <sub>D</sub> cont. (amps)	P <sub>D</sub> (watts)	Die
	STFM150	100	0.07 @ 34	34.0	150	IRFC150
	STFM240	200	0.18 @ 18	18.0	125	IRFC240
	STFM250	200	0.10 @ 27.4	27.4	150	IRFC250
	STFM340	400	0.55 @ 10	10.0	125	IRFC340
	STFM350	400	0.315 @ 14	14.0	150	IRFC350
	STFM440	500	0.85 @ 8.0	8.0	125	IRFC440
	P-Channel STFM9240	-200	0.415 @ 8.4	-11.0	125	IRFC9240

Package	Part Number	BV <sub>DSS</sub> (volts)	R <sub>DS(ON)</sub> @ I <sub>D</sub> (A) (ohms)	I <sub>D</sub> cont. (amps)	P <sub>D</sub> (watts)	Die
	SNF401002	100	0.025 @ 37	60.0	150	IXTD67N10
	SNF402005	200	0.05 @ 25	50.0	250	IXTD50N20
	SNF403009	300	0.085 @ 20	40.0	250	IXTD40N30
	SNF404025	400	0.315 @ 9.6	16.0	250	IRFC350
	SNF40402	400	0.23 @ 12.5	25.0	300	IRFC360
	SNF40504	500	0.31 @ 21	21.0	300	IRFC460
	SNF40505	500	0.5 @ 10.7	21.0	250	IXTD21N50
	SNF41013	1000	1.3 @ 5.0	10.0	250	IXTD10N100

## Part Number Ordering Information

### NOVA Part Numbers

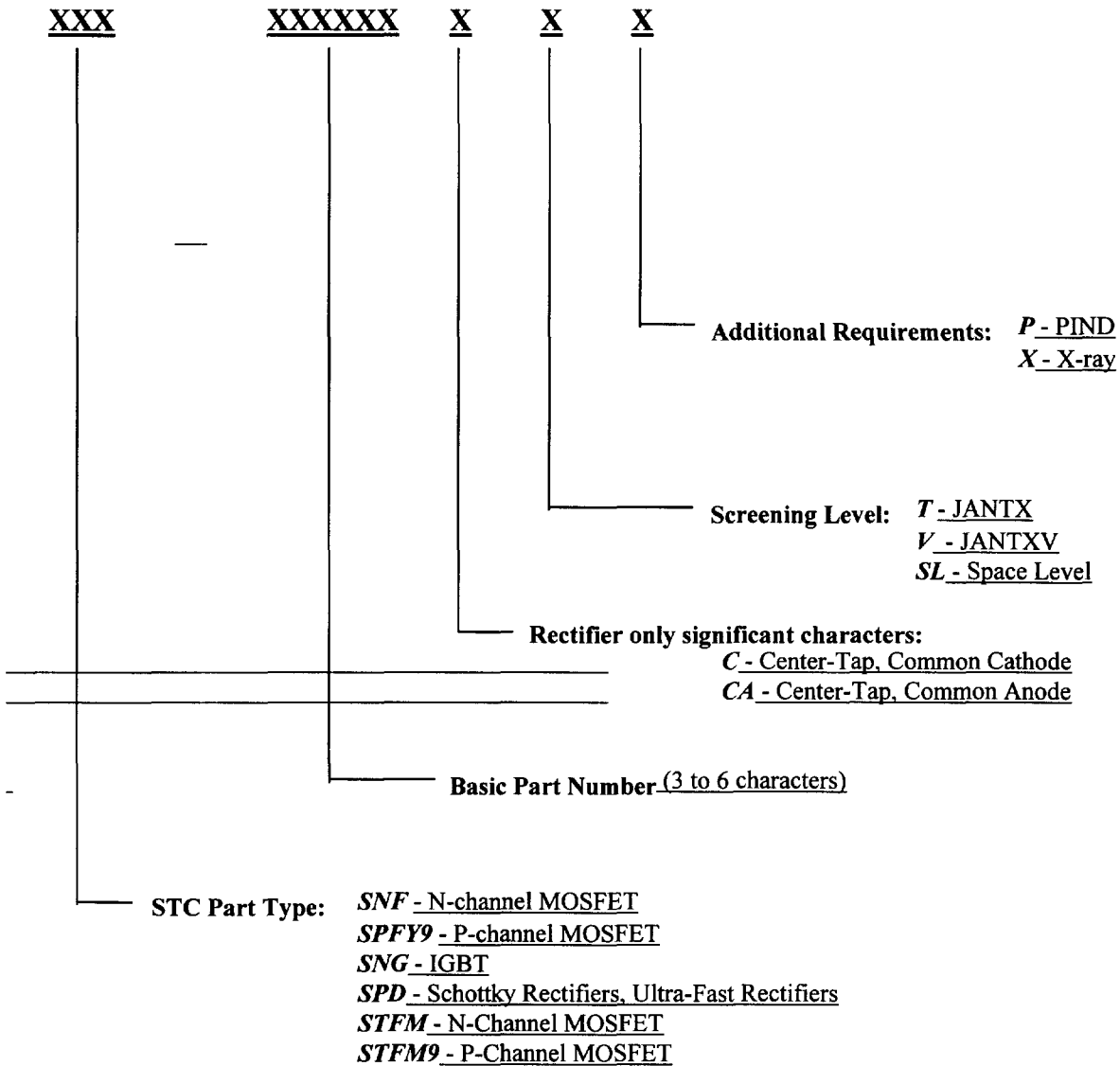

## Package Outlines

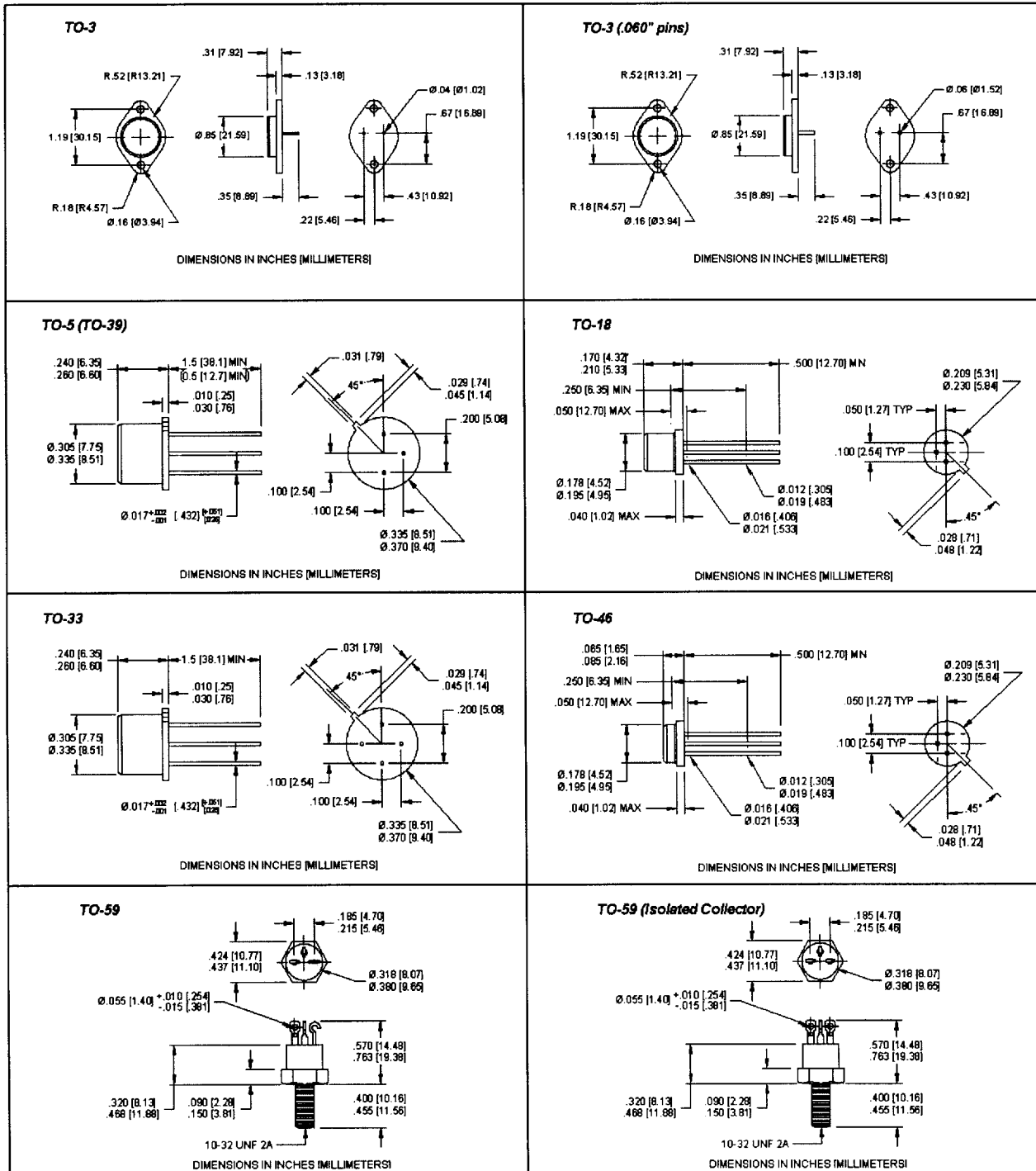

## Package Outlines

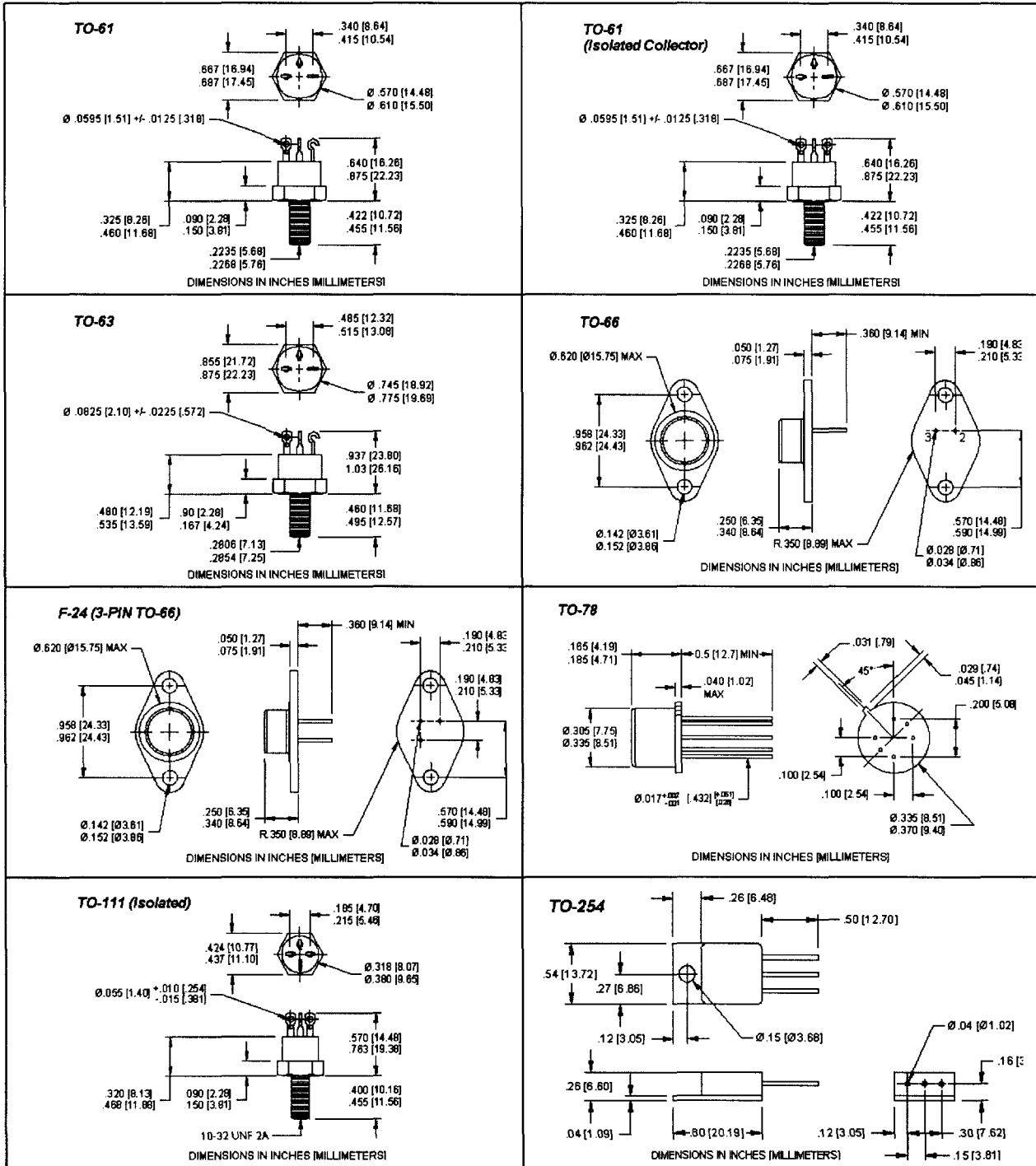

## Package Outlines

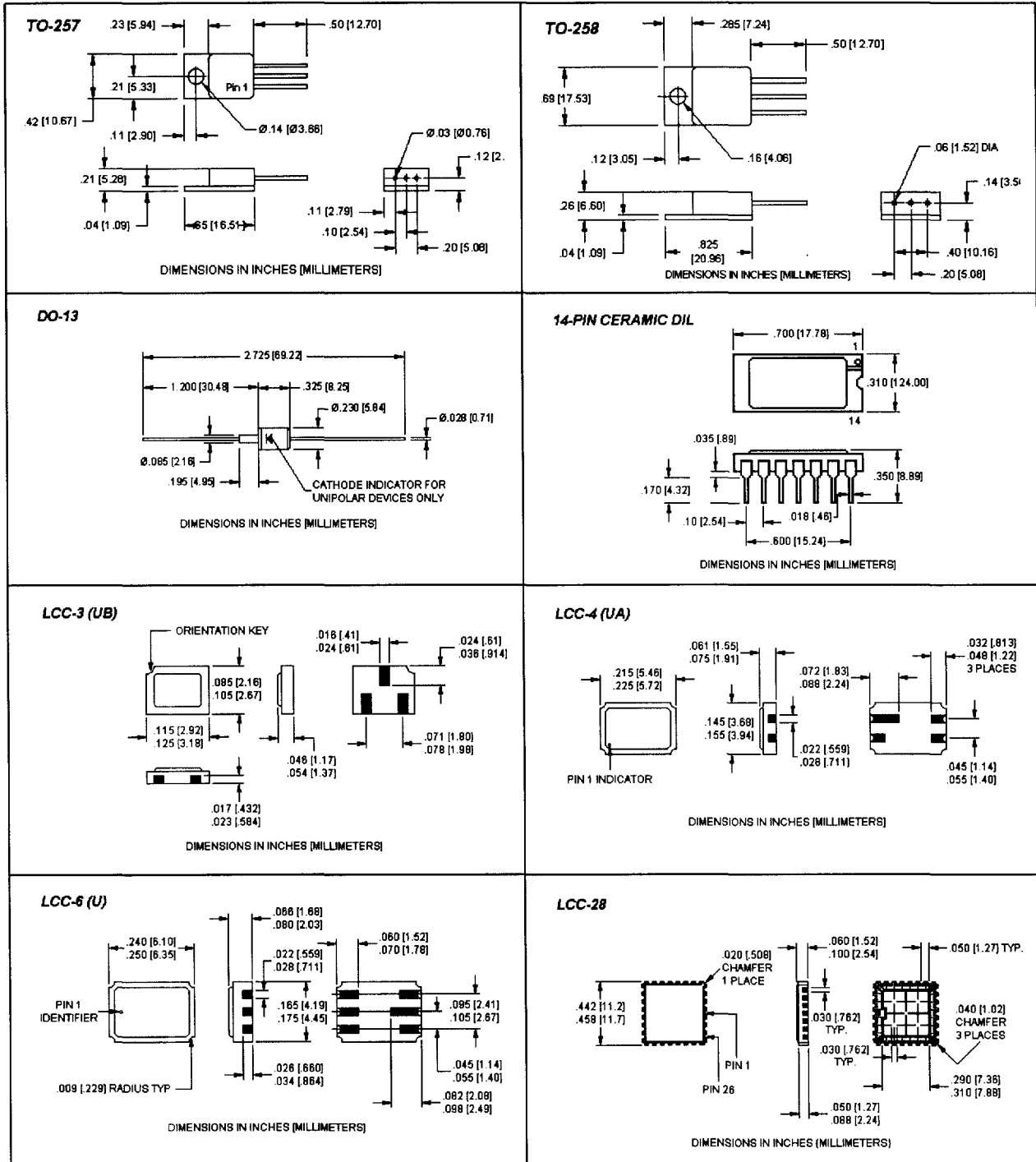

## Package Outlines

