



Sullins Headers

.050" [1.27] Male Shrouded Box Headers, Straight, Right Angle, SMT With or Without Post

SPECIFICATIONS

- **Centered Polarizing Notch**
- Operating Temperature: - 40° C to + 85° C
- Processing Temperature: 230° C for 60 seconds Max.
(260° C, 10 seconds)
- UL Flammability Rating: 94V-0
- Voltage Rating: 20m OHMs Max.
- Current Rating: 1 AMP per contact
- Voltage Drop: AC 500 V.
- Insulation Resistance: 1000 Mega OHMS
- **Mates with SFH31 series (See opposite page)**

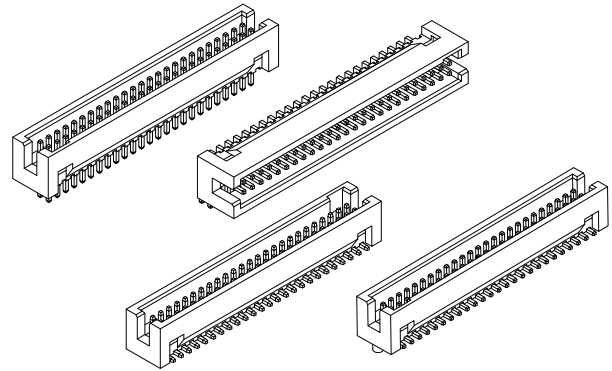

PART NUMBER OPTIONS

SBH31 - N B P B - D 10 - ST - BK

SERIES ————— SBH31 = Male Box Header with Centered Polarizing Notch, .050" [1.27mm] Contact Centers

HOUSING MATERIAL ————— N = Nylon 6T

CONTACT MATERIAL ————— B = Brass

CONTACT FINISH - RoHS Compliant ————— P = Gold Flash Overall

CONTACT CENTERS ————— B = .050" [1.27mm]

COLOR
BK = Black
Other Color Options Available
(Consult Factory)

TERMINATION TYPE
ST = Straight
RA = Right Angle
SM = Surface Mount
SP = Surface Mount with Post

NUMBER OF CONTACT POSITIONS (Pins per Row)
05 thru 50

NUMBER OF ROWS
D = Dual Row

DIMENSIONS For complete drawings, go to www.sullinscorp.com or e-mail techsupport@sullinscorp.com

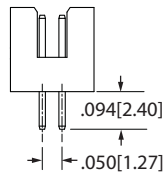

STRAIGHT (ST)
Example P/N: SBH31-NBPP-D20-ST-BK

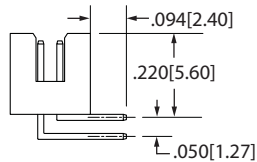

RIGHT ANGLE (RA)
Example P/N: SBH31-NBPP-D20-RA-BK

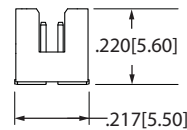

SURFACE MOUNT (SM)
Example P/N: SBH31-NBPP-D20-SM-BK

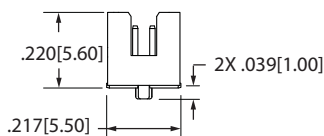

SURFACE MOUNT with POST (SP)
Example P/N: SBH31-NBPP-D20-SP-BK

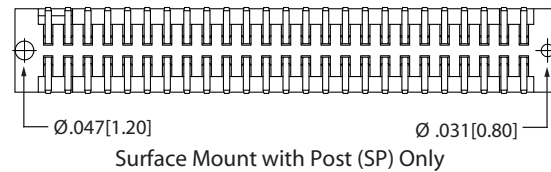
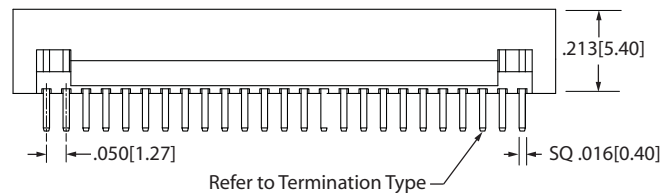
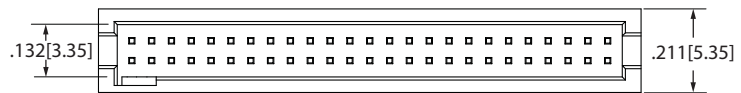



.050" [1.27] Female Header, SMT with Posts

SPECIFICATIONS

- Operating Temperature: - 40° C to + 85° C
- Processing Temperature: 230° C for 60 seconds Max.
(260° C, 10 seconds)
- UL Flammability Rating: 94V-0
- Voltage Rating: 20m OHMs Max.
- Current Rating: 3 AMP per contact
- Dielectric Withstanding: 500 VAC
- Insulation Resistance: 1000 Mega OHMS
- **Mates with SBH31 series (See opposite page)**

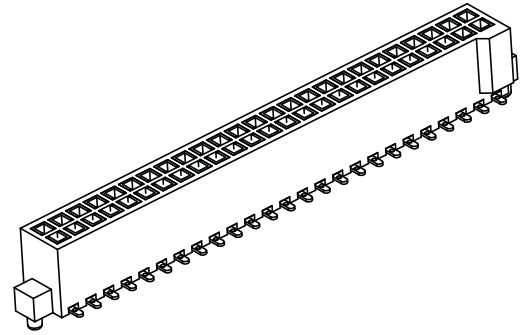

PART NUMBER OPTIONS

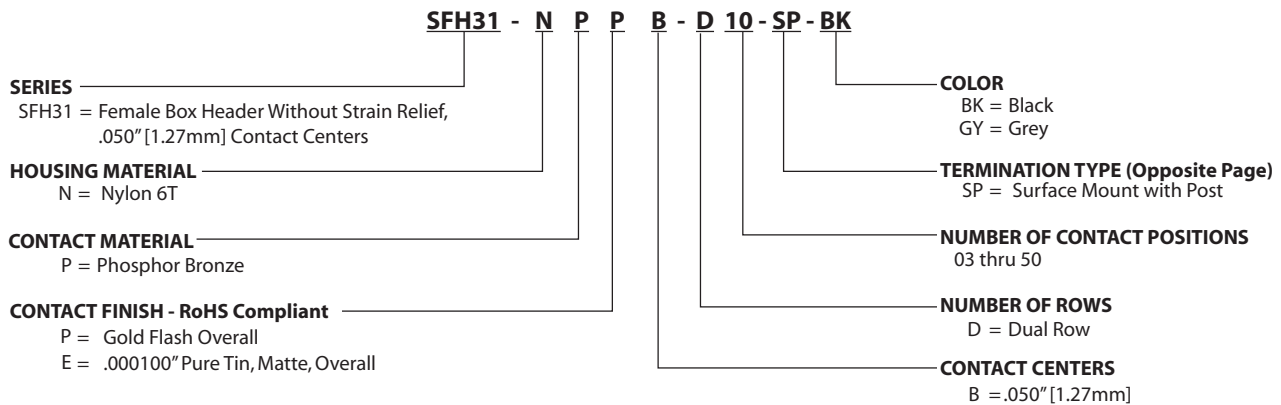

DIMENSIONS For complete drawings, go to www.sullinscorp.com or e-mail techsupport@sullinscorp.com

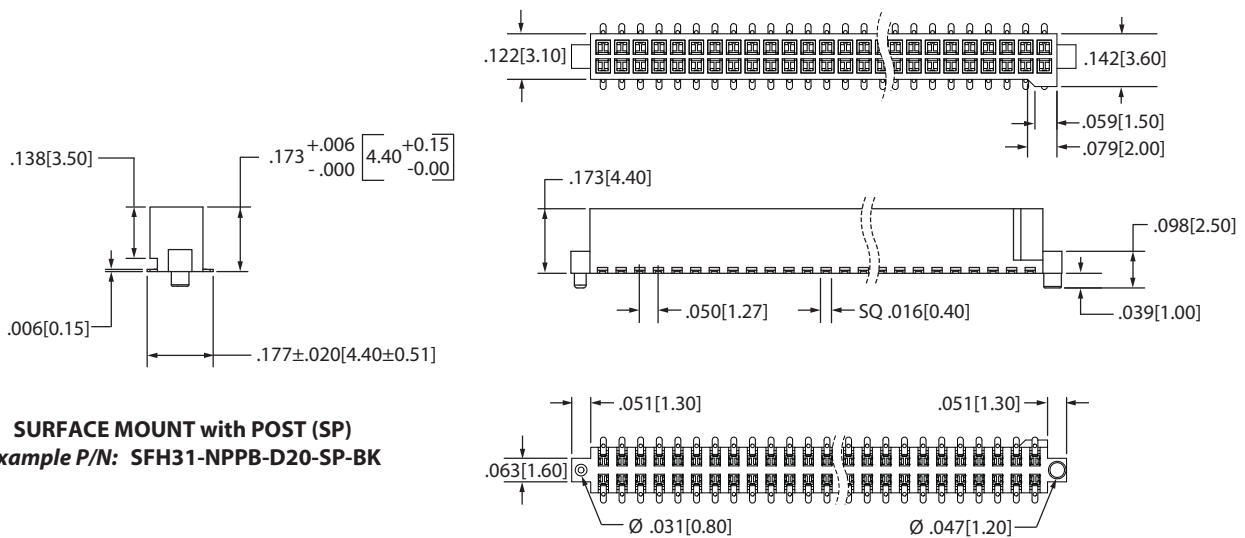

Sullins Headers